



VIavi

**OLP-88
OLP-88P
SmartClass™ Fiber**

User's Guide
BN 2327/98.21
2015.12
English

Please direct all inquiries to your local Viavi sales company. The addresses can be found at:

www.viavisolutions.com/en-us/contact-sales-expert

A description of additional instrument features can be found at:

www.viavisolutions.com/en-us/products/network-test-and-certification

Notice

Every effort was made to ensure that the information in this document was accurate at the time of printing. However, information is subject to change without notice, and Viavi reserves the right to provide an addendum to this document with information not available at the time that this document was created.

General Public License

This product includes Qt 4.8.3 software licensed under the GNU LGPL v. 2.1, and barebox 2013.03.0 and linux 3.10.26 software licensed under the GNU GPL v. 3. To request a copy of the source code for this software, please write to:

Open Source Request • Viavi Legal Department •
430 N. McCarthy Blvd. • Milpitas, CA 95035 USA

Copyright

© Copyright 2015 Viavi Solutions Inc. All rights reserved.

Viavi and the Viavi logo are trademarks of Viavi Solutions Inc.

All other trademarks and registered trademarks are the properties of their respective owners.

Viavi Solutions Deutschland GmbH
Arbachtalstraße 5, D-72800 Eningen u. A.

Order no.: BN 2327/98.21

Version: 2015.12

Previous version: –

Notes:

Changes may be made to specifications, descriptions and delivery information.

CONTENTS

INTRODUCTION	5
OLP-88/88P TruePON Testers	5
Operating manual update	8
Symbols used in this operating manual	8
SAFETY INFORMATION	11
Warning symbols on the unit	11
Proper usage	11
Laser safety	12
Battery operation	13
Ventilation	13
PS4 Universal AC/DC Power Supply	13
GETTING STARTED	15
Unpacking the instrument	15
Connecting optical cables	22
BASIC OPERATION	23
Switching the instrument on/off	23
Operator control panel	23
Display elements	24
Navigating in the menus	25
Getting help and information	25
Configuring the instrument	26
Software options	30
TRUEPON OPERATION	32
Preparing the TruePON measurement	32
General view of the TruePON application	33
Detail views of the TruePON application	35
Edit the location/threshold settings	37
Enabling the pass/fail evaluation	37
Changing the serial number format	37
Displaying the measurement view	38

PROBE/PCM OPERATION	39
General information	39
Patch Cord Microscope (PCM)	39
FMAE series adapters for the PCM	40
Features available with the P5000i Digital Probe	40
QuickCapture™ key	42
File toolbar	42
Configuring the Digital Probe	43
MEMORY MANAGEMENT	47
General information	47
Selecting the project to save or display results	49
Saving results	50
Displaying stored results	51
Using the Link Data Mode	52
Clearing the memory	53
MAINTENANCE	55
Cleaning the test port	55
Cleaning the instrument	56
REMOTE CONTROL	57
Communication interface	57
Command parameters and responses	60
Commands	61
Error messages	80
SPECIFICATIONS	81
Functionality	81
Technical specifications	81
General specifications	82
Patch cord microscope specifications	82
PS4 Universal AC/DC Power Supply	83
ORDERING INFORMATION	84
OLP-88/OLP-88P stand alone unit	84
Included items	84
Hardware options	84
Software options	84
Accessories	84

1 INTRODUCTION

OLP-88/88P TruePON Testers

This manual applies to the following models:

- BN 2327/36
- BN 2328/36

The SmartClass™ Fiber OLP-88/88P TruePON Tester is the first compact handheld test instrument that combines

- a professional PON power meter for qualification, activation, and troubleshooting passive optical networks,
- with automatic pass/fail analysis,
- fiber end face inspection,
- ONU/ONT serial number identification,
- and optional detection of rogue ONUs or ONTs.

The OLP-88/88P instruments blend a high-performance λ -selective FTTx/PON power meter for B-PON, E-PON, G-PON and automated fiber inspection and test capabilities.

Thanks to the automatic ODN budget class detection, it provides an immediate pass/fail indication and enables to check if the network and customer ONUs/ONTs meet expected specifications at the 1310 nm, 1490 nm, and 1550 nm PON power levels.

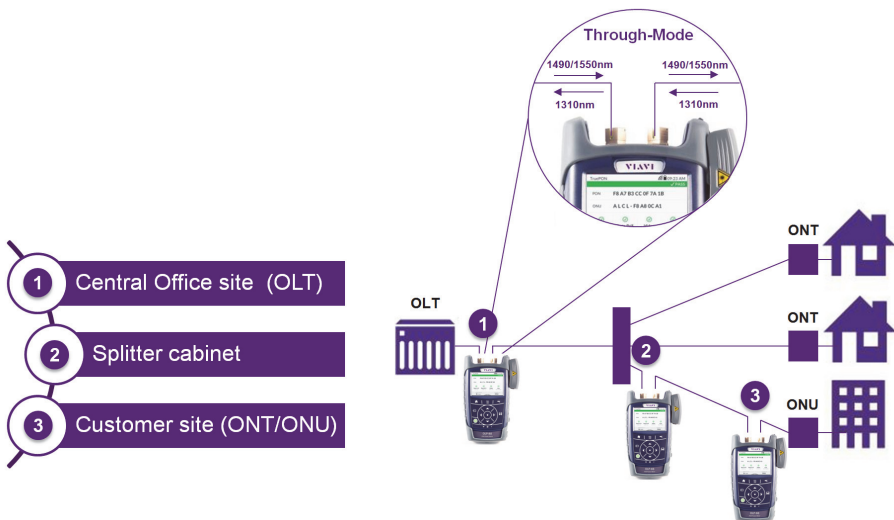

Fig. 1 Performing a measurement in a PON network

An integrated pass/fail analysis feature simplifies standard conformity testing and provides unambiguous measurement result presentation.

For all G-PON systems the ONU/ONT serial number is automatically provided. G-PON systems carrying PON-ID¹, the OLP-88/-88P performs insertion loss measurements without referencing, auto setting of pass/fail thresholds based on ODN budget class, and identification of OLT.

Battery operation from AA dry cells or from a rechargeable Li-Ion Battery Pack ensure long operating time in the field and a robust, shock-proof design makes the SmartClass™ Fiber OLP-88/88P instruments the perfect choice for FTTx/PON testing, even under tough conditions.

Operation from an AC/DC power supply and remote control capabilities via USB 2.0 and Ethernet make the SmartClass™ Fiber OLP-88/88P instruments even a perfect solution for fixed installations in central offices, in production environments, and on the laboratory workbench.

Common features

All OLP-88 series PONmeters can connect to single mode fibers (9/125 μm).

Tests on systems from different manufacturers with different connector types are easy to handle due to the interchangeable adapter system.

Connector type

The connection is made with a contact type connector. Make sure that the connectors used are designated .../APC.

Selective power measurements

All OLP-88 instruments feature a ports to which PON downstream and upstream links (from OLT, Optical Line Termination and ONT, Optical Network Termination) can be connected. The signals at wavelengths 1310 nm, 1490 nm, and 1550 nm are filtered and measured separately. These power meter ports are calibrated at the respective center wavelength.

1 PON-ID is G-PON system specific information standardized by ITU-T G.984.3 Amendment 3

Through path

The through path links the ONT upstream (1310 nm) and OLT downstream (1490 nm and 1550 nm) signals. Thanks to the low insertion loss the OLP-88 can be inserted into the PON network transparently.

Burst power measurements at 1310 nm

The OLP-88 can also be used to measure burst type signals as found in PON uplink paths at 1310 nm. The average burst power is displayed independently from the burst duty cycle (active/ idle). This power meter port is calibrated at the respective center wavelength.

Differences between the Viavi instruments

		OLP-37	OLP-87	OLP-88
Supported services	B-PON, G-PON, E-PON	X	X	X
	XG-PON test capability	–	Special version	–
	CATV Video test capability	X	X	X
	RFoG test capability	X	X	–
	Upstream 1310nm test capability (through mode)	–	X	X
Functions	Broadband power meter	–	X	–
	ONU/ONT identification	–	–	X
	ODN budget class detection and auto threshold setting	–	–	X
	In-service loss-test with auto pass/fail analysis	–	–	X
	OLT identification	–	–	X
	Alien/rogue ONU/ONT detection	–	–	X
Fiber inspection		–	Option	Option

Operating manual update

Continuing enhancement and further development of the SmartClass™ Fiber family may mean that this operating manual does not cover all the latest functions of your instrument.

If the operating instructions about features provided by your instrument are missing, please visit the Viavi web site to check if additional information is available.

To download the latest user manual:

1. Visit the Viavi web site at <http://updatemyunit.net>.
2. Select your SmartClass™ Fiber model from the product line.
3. Open the download area and download the latest user manual.

Symbols used in this operating manual

Various elements are used in this operating manual to draw attention to special meanings or important points in the text.

Symbols and terms used in warnings

The following warnings, symbols and terms are used in this document in compliance with the American National Standard ANSI Z535.6-2011:

NOTICE

Follow the instructions carefully to avoid **damage or destruction to the instrument**.

⚠ CAUTION

Follow the instructions carefully to avoid a low or medium risk of **injury to persons**.

⚠ WARNING

Follow the instructions carefully to avoid **severe injury** to persons.

⚠ DANGER

Follow the instructions carefully to avoid **death or severe injury** to persons.



High voltage

Follow the instructions carefully to avoid **damage** to the instrument or **severe injury** to persons.

This safety instruction is given if the danger is due to **high voltage**.



Laser

Follow the instructions carefully to avoid **damage** to the instrument or **severe injury** to persons.

This safety instruction is given if the danger is due to **laser radiation**. Information specifying the laser class is also given.

Warning format

All warnings have the following format:

⚠ WARNING

Type and source of danger

Consequences of ignoring the warning.

- ▶ Action needed to avoid danger.

The following character formats are used in this operating manual:

√	<p>Requirement</p> <p>This requirement must be met first; e.g.</p> <p>√ The system is switched on.</p>
▶ 1. 2.	<p>Instruction</p> <p>Follow the instructions given (the numbers indicate the order in which the instructions should be followed); e.g.</p> <p>▶ Select mode.</p>
<i>Italics</i>	<p>Result</p> <p>Indicates the result of following an instruction; e.g.</p> <p><i>The page opens.</i></p>
Boldface	<p>Pages, controls, and display elements</p> <p>Screen pages, controls, and display elements are indicated in boldface.</p>
Text in blue	<p>Cross references</p> <p>Cross references are indicated in blue type. When using the PDF version, just click on the blue text to skip to the cross reference.</p>
[F]	<p>Instrument keys</p> <p>Instrument keys are indicated within square brackets.</p>
[More]	<p>Touchscreen buttons</p> <p>Touchscreen buttons are indicated within square brackets.</p>

2 SAFETY INFORMATION

Warning symbols on the unit



Warning symbols indicating a potential hazard

- ▶ In all cases where the unit is labeled with a warning symbol, the operating manual must be consulted to learn more about the nature of the potential hazard and any action that must be taken.
-

Proper usage

This instrument is intended for measurements on optical fiber devices and systems.

- ▶ Please make sure the instrument is not operated outside the permitted ambient conditions.
- ▶ Always make sure that the instrument is in proper working order before switching it on.

Laser safety



⚠ WARNING

Dangerous laser radiation

Laser radiation can cause irreparable damage to eyes and skin.

The maximum permitted power for the OLP-88 means that the optical input signals can reach hazard level.

Bear this in mind when using the OLP-88. In particular, the instrument is equipped with a through channel that transmits all the optical radiation from the input to the output without attenuation, even when the OLP-88 is switched off.

- ▶ Please note that also in broadband mode light is emitted at the unconnected port.
 - ▶ Always be aware of the hazard level of the instrument to be connected.
 - ▶ Connect all optical fibers before switching on the radiation source.
 - ▶ Switch off the laser source before disconnecting the optical fibers.
 - ▶ Never look directly into the unconnected port of the instrument, the output of a laser source, or an optical fiber connected to a source or a system.
 - ▶ Always cover unused ports.
 - ▶ Be aware that the emitted light is not visible.
 - ▶ Heed the normal precautions for working with laser radiation and consider local regulations.
-

Battery operation

⚠ WARNING

Explosion danger

Short-circuiting the batteries can result in overheating, explosion, or ignition of the batteries and their surroundings.

- ▶ Never short-circuit the battery contacts by touching both contacts simultaneously with an electrical conducting object.
 - ▶ Only use AA size dry batteries or rechargeable batteries.
 - ▶ Make sure the batteries are inserted with the correct polarity.
-

Ventilation

NOTICE

Insufficient ventilation

Insufficient ventilation can damage the instrument or adversely affect its function and safety.

- ▶ Ensure adequate ventilation when operating the instrument.
-

PS4 Universal AC/DC Power Supply

Safety class

The PS4 Universal AC/DC Power Supply unit has a protective isolation that conforms with IEC 60950.

Environmental conditions

NOTICE

Ambient temperature too high/low

Temperatures outside the operating range of 0 to +40 °C can damage the PS4 Universal AC/DC Power Supply or adversely affect its function and safety.

- ▶ Only operate the PS4 Universal AC/DC Power Supply indoors.
The PS4 Universal AC/DC Power Supply must only be operated at ambient temperatures between 0 and +40 °C.

NOTICE

Insufficient ventilation

Insufficient ventilation can damage the PS4 Universal AC/DC Power Supply or adversely affect its function and safety.

- ▶ Ensure adequate ventilation when operating the PS4 Universal AC/DC Power Supply.

NOTICE

Condensation

Operation in the presence of condensation can damage the PS4 Universal AC/DC Power Supply or adversely affect its function and safety.

- ▶ Do not operate the PS4 Universal AC/DC Power Supply if condensation has formed.
 - ▶ If condensation cannot be avoided, such as when the PS4 Universal AC/DC Power Supply is cold and is moved to a warm room, wait until the PS4 Universal AC/DC Power Supply Unit is dry before plugging it into the AC power line.
-

3 GETTING STARTED

Unpacking the instrument

Packing material

We suggest that you keep the original packing material. It is designed for reuse (unless it is damaged during shipping). Using the original packing material ensures that the instrument is properly protected during shipping.

Checking the package contents

- Unpack the instrument and check the package contents. For more information see ["Included items"](#) on page 84.

Checking for shipping damage

After you unpack the instrument, check to see if it was damaged during shipping. This is particularly likely if the packaging is visibly damaged. If there is damage, do not attempt to operate the instrument. Doing so can cause further damage. In case of damage, please contact your local Viavi sales company. Addresses can be found at www.viavisolutions.com.

Recovery following storage/shipping

Condensation can occur if a instrument that is stored or shipped at a low temperature is brought into a warm room. To prevent damage, wait until no more condensation is visible on the surface of the instrument before powering it up. Do not operate the instrument until it has reached its specified temperature range and wait until it has cooled down if the instrument was stored at a high temperature (see ["General specifications"](#) on page 82).

Instrument overview



Fig. 2 Front view OLP-88 and OLP-88P

-
- | | |
|---|--|
| 1 | Patch cord microscope (PCM) with FMAE adapter |
| 2 | PCM controls: focus control, automated Pass/Fail analysis, magnification control |
| 3 | Optical test ports with interchangeable test adapters |
| 4 | Test head cover (green for APC- and gray for PC connectors) |
| 5 | 3.5 inch touchscreen |
| 6 | Key pad (operator control panel) |
| 7 | Battery compartment and stand (on rear of instrument) |
-

Connector panel

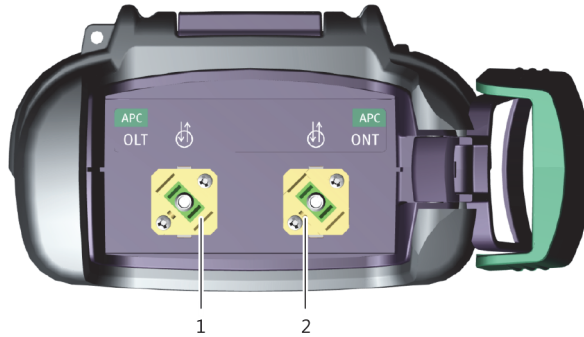

Fig. 3 Connector panel

-
- 1 Optical test port 1: Downstream
Connection to OLT facing side of the PON
-
- 2 Optical test port 2: Upstream
Connection to ONU/ONT facing side of the PON
-

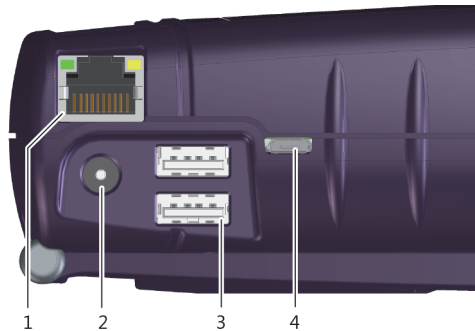

Fig. 4 External power supply connector and communication interfaces

-
- 1 Ethernet port (RJ-45)
-
- 2 External power supply connector (12 V)
-
- 3 USB 2.0 host port (Type A)
-
- 4 USB 2.0 device port (Type Micro-B)
-

Power supply

The following power sources can be used to operate the OLP-88:

- Eight 1.5 V dry batteries
(Mignon AA size, alkaline type recommended)
- Eight 1.2 V NiMH rechargeable batteries
(Mignon AA size, no internal charge)
- PS4 Universal AC/DC Power Supply
- RBP2 LiIon Battery Pack

Battery operation

⚠ WARNING

Dangers when handling batteries

Handling batteries may be dangerous. Please note the following safety instructions.

- ▶ Please note the battery operation safety information in the chapter “[Battery operation](#)” on page 13.

Replacing batteries

- ▶ Do not replace individual batteries. Always change all eight batteries at the same time.
- ▶ Always use eight batteries of the same type; i.e. do not mix rechargeable and non-rechargeable batteries.

Replacing batteries



Fig. 5 Replacing the batteries

- | | |
|---|-------------------------|
| 1 | RBP2 LiIon Battery Pack |
| 2 | Latch lock |
| 3 | AA battery tray |

The battery compartment is on the back of the instrument.

1. Press down the latch to release and to open the lid of the battery compartment.
2. Insert new batteries or remove the used batteries and replace them with fresh ones.

NOTICE: Take care to insert the batteries correctly. The correct polarity is indicated by a diagram inside the battery compartment.

– or –

1. Press down the latch lock to release the battery tray.
2. Insert the RBP2 LiIon Battery Pack.
3. Close the battery compartment.
4. Press the [o] key to switch on.

Recharging the batteries

The rechargeable RBP2 LiIon Battery Pack is recharged when the PS4 Universal AC/DC Power Supply is being used to power the instrument. The instrument switches to trickle charging automatically as soon as the RBP2 LiIon Battery Pack is fully charged.

Note: Rechargeable AA batteries will not be recharged in the instrument. For AA-type rechargeable batteries please use an external charger.
It is not possible to charge the rechargeable AA batteries or the RBP2 LiIon Battery Pack via the USB interface.

The instrument is powered by the PS4 Universal AC/DC Power Supply if the PS4 Universal AC/DC Power Supply and the USB interface are both connected.

General tips on using batteries

- Always handle batteries with care.
- Do not drop or damage the batteries or expose them to excessively high temperatures.
- Do not store the batteries for more than one or two days at very high temperatures (e.g. in a vehicle), either separately or inserted in the instrument.
- Do not leave discharged batteries in the instrument for a long time if it is not being used.

Other basic safety precautions are as follows:

- Do not use PS4 Universal AC/DC Power Supply outdoors or in wet or damp locations.
- Connect the PS4 Universal AC/DC Power Supply to the correct mains voltage, as indicated on the rating label.
- Do not allow anything to rest on the power cord, and do not place the product where people can walk on the power cord.
- Avoid using this product during electrical storms. There may be a remote risk of electric shock from lightning.
- Do not use this product in the vicinity of a gas leak or in any explosive environment.
- Do not attempt to service this product yourself, as opening or removing covers may expose you to dangerous, high voltage points, and other hazards. Contact qualified service personnel for all service.

Environmental protection

Please dispose of any unwanted dry batteries and rechargeable batteries carefully. They should also be removed from the instrument if it is to be discarded. If facilities in your country exist for collecting such waste or for recycling, please make use of these rather than throwing the batteries in with normal trash. You will often be able to return used batteries to the place where you purchase new ones. Any dry or rechargeable batteries that you purchased from Viavi can be returned to one of our Service Centers for disposal.

Operation from AC power

NOTICE: Only the PS4 Universal AC/DC Power Supply may be used to operate the OLP-88 from AC power.

To fit the AC line plug adapter:

1. Select the appropriate AC line plug adapter.
2. Slide the AC line plug adapter into the slot.

The PS4 Universal AC/DC Power Supply is ready for use.

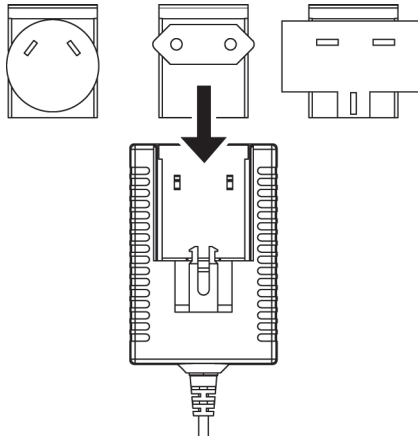

Fig. 6 PS4 Universal AC/DC Power Supply

To change the AC line plug adapter:

1. Squeeze both sides of the PS4 latch lock (see Fig. 6).
2. Push the AC line plug adapter upwards.
3. Slide a different AC line plug adapter into the slot (see Fig. 7).

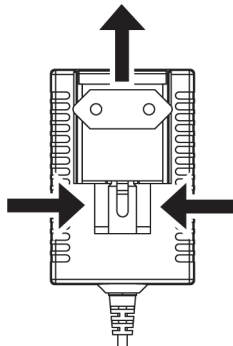

Fig. 7 PS4: Changing the AC line plug adapter

To operate the OLP-88 from AC power:

1. Connect the PS4 DC power cord to the OLP-88 external power supply connector.
(The connector is under the cover on the right side.)
2. Plug the PS4 into the AC line socket.
The OLP-88 switches on automatically when powered from the PS4.

Note: The PS4 provides power even if dry or rechargeable batteries are inserted in the instrument.
The OLP-88 cannot be powered via the USB interface.

Connecting optical cables

Mounting test adapters

Viavi provides a number of test adapters for connecting the OLP-88 to the interface to be tested.

You can connect all standard optical connector types to the instrument using these adapters. The test adapters are suitable for connectors with angled end surfaces (APC).

Contact your local Viavi sales company for available adapter types.

The OLP-88 connector type must match the cable connector type:

- APC: BN 2327/36, BN 2327/36

The PC/APC versions are easily identified by the colors of the name labels on the front:

- PC = blue
- APC = green

To mount the SENKO test adapter:

- ✓ The optical connectors are properly cleaned (see “[Cleaning the test port](#)” on page 55).
1. Open the head cover and remove the protective cap (if still mounted).
 2. Unscrew the SENKO test adapter and pull it off vertically.
 3. Place the SENKO test adapter vertically on the optical connector.
 4. Fix the SENKO test adapter with two screws.
 5. Repeat the procedure if the instrument is fitted with two ports.
 6. Fit the fiber optic cable to the test adapter or close the head cover.

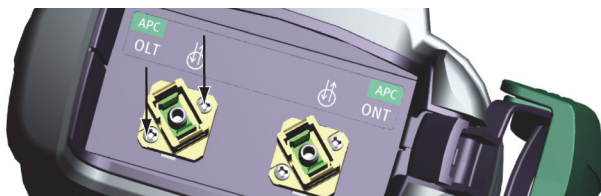

Fig. 8 Mounting the SENKO test adapter

4 BASIC OPERATION

Switching the instrument on/off











To switch the instrument on:

- ▶ Press the [⏻] key to switch on the instrument.

To switch the instrument off:

- ▶ Press the [⏻] key to shift the instrument in hibernate mode.
 - or –
- 1. Hold the [⏻] key to open the power off menu.
- 2. Tap the [Power Off] button to switch off the instrument.

Operator control panel

	Press to go to the homescreen.
	Press to open menu.
	Press to go back within an application or cancel input.
	Press to toggle between the inspect view and the test view.
	Press to switch the instrument on and off. LED glows green when the instrument is on.
	Press an arrow key to: <ul style="list-style-type: none"> • Navigate through the menus • Change values in the menus Press the centered key to: <ul style="list-style-type: none"> • Confirm the selection
	Press to save results.
	Glows red when battery is low.
	Glows red when a measurement is running in the background.
	Glows orange when battery is charged; flashes orange when battery is charging. Turned off when dry batteries are used or battery bay is empty.

Display elements



Fig. 9 Homescreen

	<p>Link Data Mode The saved results of any application are assigned to a dedicated project and FiberID.</p>
	<p>Auto-Off Indicates whether the instrument turns off within a certain time.</p>
	<p>External power supply The OLP-88 is powered by the external AC adapter when this symbol is shown.</p>
	<p>Battery status Indicates the battery charge status. If it is not shown, only the AC adapter is active.</p>
	<p>TruePON To measure the Passive Optical Networks (PON) power level of 1490/1550 nm downstream or 1310 nm upstream signals, to identify ONT/OLT/ONU, to detect alien/rogue ONU/ONTs, to test in-service loss, and to analyze fiber end face with auto pass/fail analysis.</p>
	<p>Probe To view and inspect the bulkhead (female) connectors.</p>
	<p>Patch Cord Microscope (only BN 2328/36) To view and inspect the patch cord connector of the fiber.</p>

Navigating in the menus

- ▶ Press the [≡] key to open the context-sensitive menu.
Depending on which application is in the foreground, a different menu opens.

To select a menu item:

1. Press the arrow keys to highlight an item.
2. To confirm, press the center key within the arrow keys.
 - or –
 - Tap the desired button on the touchscreen.

To leave a menu without making any changes:

- ▶ Press the [↶] key.

Note: All actions can be operated via the operator control panel or the touchscreen. The following instructions describe only touchscreen operation.

To toggle between different display modes:

- ▶ Tap on the display to toggle between the display modes (context-sensitive).

Getting help and information

- √ The homescreen is displayed.
- 1. Press the [≡] key and tap the [Help] button.
- 2. To show the instrument's operating manual, tap the [Manual] button.
 - or –
 - To show information about calibration, software, and hardware, tap the [Info] button.

To navigate through the manual:

- √ The manual is displayed.
- 1. Press the [≡] key.
- 2. To resize the displayed content, tap the [Zoom in] button, the [Zoom out] button, or the [Default Zoom] button.
 - or –
 - To go to the previous or next page, tap the [Back] or [Forward] button.

Configuring the instrument

System Settings menu overview

- ✓ The homescreen is displayed.
- ▶ Press the [≡] key and tap the [Settings] button.
The **System Settings** menu opens:

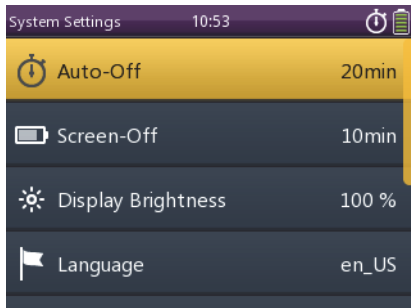

The following table gives a short overview of the menu items. These are explained in the sections below.

Auto-Off	To adjust the switch-off period of the instrument.
Screen-Off	To adjust the switch-off period of the screen.
Display Brightness	To adjust the display brightness.
Language	To select the language of the instrument texts.
Date & Time	To adjust the date, date format, time, and to set 24-hour time or 12-hour time.
Date	To adjust the date.
Date Format	To adjust the date format.
Time	To adjust the time.
Time Format	To set 24-hour time or 12-hour time.
Ethernet	To set the communications protocols.
IP Mode	To select either static or DHCP Ethernet mode.
IP Address	To set the IP-address in static Ethernet mode.
Gateway	To set the gateway in static Ethernet mode.
Netmask	To set the netmask in static Ethernet mode.
MAC Address	Unique identifier assigned to network interfaces for communication on the physical network segment.

Remote Control Port	Shows the TCP port used for remote control via Ethernet.
Wifi	To configure the wireless local area networks.
Factory Reset	Set the instrument parameters and settings to their default values as defined by Viavi. This does not affect any stored measurement results.

Changing the Auto-Off setting

- ✓ The instrument is switched on.
- 1. Press the [≡] key and tap the [Settings] button.
- 2. Tap the [Auto-Off] button.
The power mode menu opens.
- 3. Select the desired setting to change the power mode.

Changing the Screen-Off setting

- 1. Press the [≡] key and tap the [Settings] button.
- 2. Tap the [Screen-Off] button.
- 3. Select the desired setting to change the screen off time.

Note: **Auto-Off** and **Screen-Off** settings are only active when no external power supply is connected.

Adjusting the display brightness

- 1. Press the [≡] key and tap the [Settings] button.
- 2. Tap the [Brightness] button.
- 3. Type in the desired brightness value.
- 4. Tap the [OK] button.

Selecting a language

- 1. Press the [≡] key and tap the [Settings] button.
- 2. Tap the [Language] button.
The language menu opens:



3. Tap the language you want to select.
– or –
Press the arrow keys to highlight the language you want to select and to confirm press the center key within the arrow keys.

Setting the date

1. Press the [≡] key and tap the [Settings] button.
2. Tap the [Date & Time] button.
3. Tap the [Date] button.
4. To change the setting, tap the [Day], [Month], or [Year] button.
5. Type in the desired value.
6. Tap the [OK] button.

Setting the date format

1. Press the [≡] key and tap the [Settings] button.
2. Tap the [Date & Time] button.
3. Tap the [Date Format] button.
4. To change the setting, tap the desired date format.

Setting the time

1. Press the [≡] key and tap the [Settings] button.
2. Tap the [Date & Time] button.
3. Tap the [Time] button.
4. To change the setting, tap the [Hour], [Minute], or [Second] button.
5. Type in the desired value.
6. Tap the [OK] button.

Setting 24-hour or 12-hour time

1. Press the [≡] key and tap the [Settings] button.
2. Tap the [Date & Time] button.
3. Tap the [Time Format] button.
4. To change the setting, tap the desired time format.

Selecting the IP mode

1. Press the [≡] key and tap the [Settings] button.
2. Tap the [Ethernet] button.
3. Tap the [IP Mode] button.
4. Tap the Ethernet mode you want to select.

Setting the IP address

- ✓ The IP mode **Static** is selected.
1. Press the [≡] key and tap the [Settings] button.
 2. Tap the [Ethernet] button.
 3. Tap the [IP Address] button.
 4. Type in the desired IP address.
 5. Tap the [OK] button.

Setting the gateway

- ✓ The IP mode **Static** is selected.
1. Press the [≡] key and tap the [Settings] button.
 2. Tap the [Ethernet] button.
 3. Tap the [Gateway] button.
 4. Type in the desired gateway.
 5. Tap the [OK] button.

Setting the Wifi (optional)

1. Press the [≡] key and tap the [Settings] button.
2. Tap the [Wifi] button.
3. Press the [≡] key and tap the desired setting.

Resetting to the factory default values

1. Press the [≡] key and tap the [Settings] button.
2. Tap the [Factory Reset] button.

Note: Setting the factory default values does not affect your stored measurement results.

Updating the firmware

The latest version of the firmware can be downloaded from the Internet.

To find the latest firmware version:

1. Visit the Viavi web site at <http://updatemyunit.net>.
2. Select your model from the product line.
3. Open the download area and download the latest firmware.
4. Unzip and save the firmware to the root of a USB flash drive.

To update the downloaded firmware:

- ✓ The instrument is fully charged or the PS4 Universal AC/DC Power Supply is connected.
 - ✓ The instrument is switched off and not in hibernate mode.
1. Press and hold down the [≡] key.
 2. Press the [⏻] key to switch the instrument on.
The firmware update screen appears.
 3. Release the [≡] key.
 4. Plug the USB flash drive into one of the instrument USB ports.
 5. To start the firmware update procedure, press the center key within the arrow keys.
If the update procedure is terminated, the instrument turns off automatically.
 6. Remove the USB flash drive.
 7. Press the [⏻] key to switch the instrument on.

Resetting the instrument

- ▶ To reset the instrument, press the [⏻] key for more than 10 seconds.
Date and time are reset and the stored measurement data remains.

Software options

To install new software options:

1. Contact your local Viavi sales company or visit the Viavi web site at www.viavisolutions.com.
2. Select a software option from the product line and order it just like an instrument.
An e-mail with the license key will be sent.
3. Save the software option to the root of a USB flash drive.
4. Plug the USB flash drive into one of the instrument USB ports.

- Press the [≡] key and tap the [Software Options] button.
The menu opens:

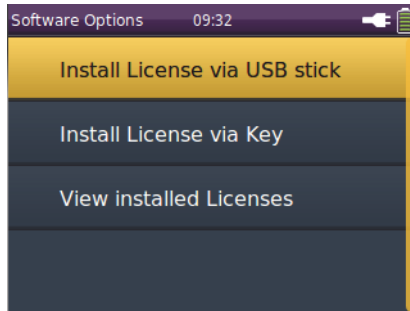

- To start the installation, tap the [Install license via USB stick] button.
– or –
To type the license key, tap the [Install license via key] button.
Successful installation or number of errors will be displayed in the following menu:

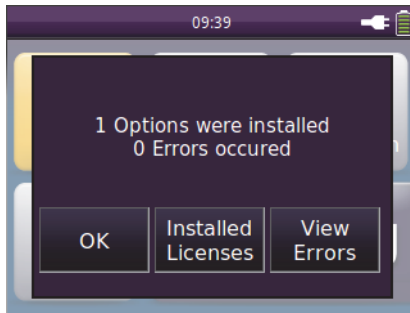

- Remove the USB flash drive.

To display the installed software options:

- ✓ The software options are installed and the confirmation menu is displayed.
 - ▶ To show the installed software options, tap the [Installed Licenses] button.
– or –
 - ✓ The homescreen is displayed.
- Press the [≡] key and tap the [Software Options] button.
 - To show the installed software options, tap the [View installed licenses] button.

5 TRUEPON OPERATION

Preparing the TruePON measurement

✓ The homescreen is displayed.

1. Tap the [TruePON] button.

A message is displayed that no signal is detected.

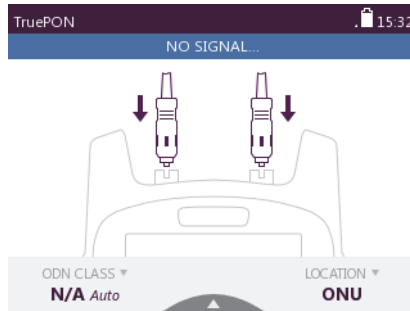

2. Connect the OLT and ONU/ONT fiber with the particular test port.

3. Tap the [ODN CLASS] button.

4. To automatically set the ODN budget class, select the **Auto**¹ button.

– or –

Select one of the predefined ODN budget classes **B**, **B+**, **C**, or **C+** according to ITU-T G.984.3.

– or –

Select the customizable ODN budget class **User**.

5. Tap the [LOCATION] button.

6. To specify the test location (central office, customer site, or splitter cabinet), select **OLT**, **ONU/ONT**, or a self-defined location.

¹ Automatic ODN budget class detection requires PON-ID option and PON-ID messages according to ITU-T G.984.3 Amendment 3

General view of the TruePON application

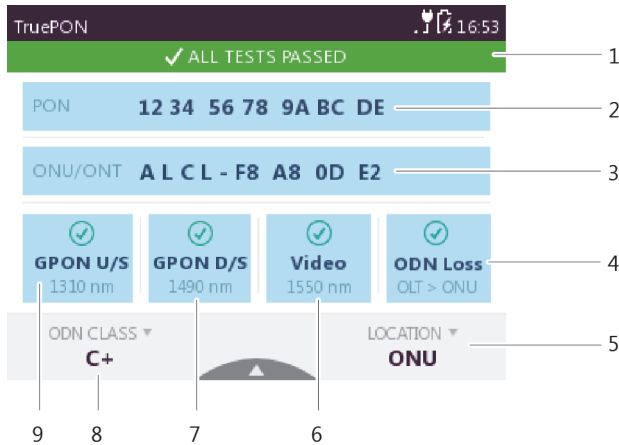

Fig. 10 General view of the TruePON application

- | | |
|---|---|
| 1 | Pass/fail summary |
| 2 | PON-ID from OLT |
| 3 | ONU/ONT serial number or Alien/Rogue ONT indication |
| 4 | Pass/fail indicator of ODN insertion loss |
| 5 | Currently selected test location |
| 6 | Pass/fail indicator of RF video signal |
| 7 | Pass/fail indicator of G-PON downstream signal |
| 8 | Currently selected ODN budget class |
| 9 | Pass/fail indicator of G-PON upstream signal |

G-PON network service activation

To verify the correct fiber connection (Fig. 10-2 – optional):

An incorrect or no labeling of fiber cables in splitter cabinets can lead to wrong ONT/customer connection.

- ✓ The OLP-88 is connected with the PON network (“Preparing the TruePON measurement” on page 32).

At any network location the OLT ID is displayed.

- Ensure that the right fiber cable is connected to the right ONT.

To reduce workflow complexity and test the service-activation (Fig. 10-3):

Since the service-activation phase is often performed by subcontractors, they must provide test reports for each turn-up. To control the service-activation reports, connect your OLP-88.

- ✓ The OLP-88 is connected with the PON network (“Preparing the TruePON measurement” on page 32).

The ONU/ONT serial number to customer service contract is displayed.

Links automatically the service-activation test results to ONT/customer.

To perform a facilitates service recovery (Fig. 10-3):

To easily identify and localize a rogue ONU that degrades or disables the service of other customers, connect your OLP-88.

- ✓ The OLP-88 is connected with the PON network (“Preparing the TruePON measurement” on page 32).

The presence of a rogue/alien ONU/ONT is detected and a message is displayed that the ONU is not compliant.

- ▶ To facilitates service recovery, isolate the faulty ONU/ONT and replacing it in time.

To perform the automatic certification (Fig. 10-6, -7, -9):

To perform a power-level verification at a customer ONT, connect the OLP-88 to certify the service specifications.

- ✓ The OLP-88 is connected with the PON network (“Preparing the TruePON measurement” on page 32).

Pass or fail information for downstream and upstream PON power level measurements (1310/1490 nm and 1550 nm) is displayed.

With the PON-ID the pass/fail thresholds of the G-PON system is automatically set.

To perform a fiber plant qualification (Fig. 10-4):

During the construction phase, the fiber plant is qualified: end-to-end loss testing ensures that the fiber link complies with the loss budget. To control the qualification several years later, connect your OLP-88.

- ✓ The OLP-88 is connected with the PON network (“Preparing the TruePON measurement” on page 32).

A real time in-service end-to-end loss measurement is performed and the pass or fail information is displayed.

Detail views of the TruePON application

- To show detailed **GTC Layer**¹ results, tap the [PON] button.
 – or –
 Tap the [ONU/ONT] button.
The following detailed view is displayed.

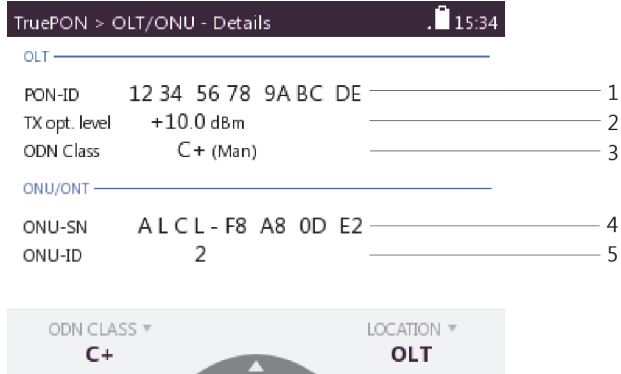

Fig. 11 GTC layer detail view

OLT data

- 1 PON-ID
- 2 Transmit Optical Level (TOL)
- 3 ODN budget class

ONU/ONT data

- 4 ONU/ONT serial number
- 5 ONU/ONT ID

- To show detailed **PMD Layer**² results for the different wavelengths, tap the [GPON U/S], [GPON D/S], [Video], [ODN Loss] button.
A detailed view is displayed.

1 G-PON Transmission Convergence Layer
 2 Physical Media Dependent Layer

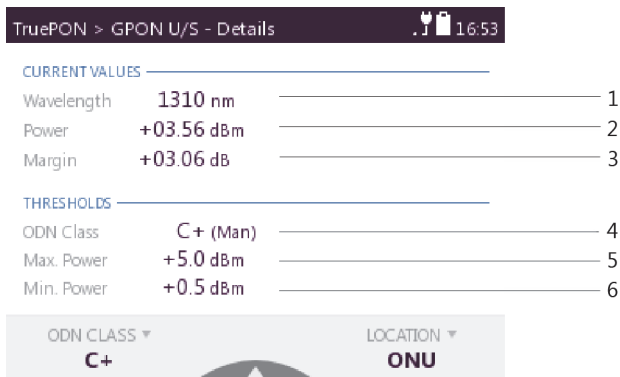

Fig. 12 PMD layer detail view

- | | |
|---|--|
| 1 | Wavelength |
| 2 | Measured power |
| 3 | Margin |
| 4 | Automatically detected or manually selected ODN budget class |
| 5 | Upper threshold |
| 6 | Lower threshold |

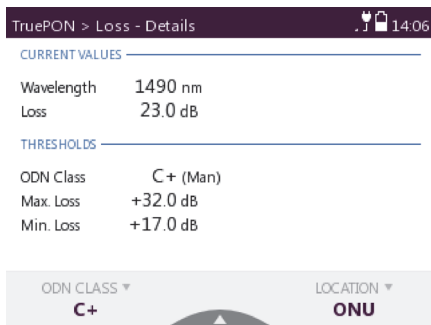

Fig. 13 ODN insertion loss detail view

Edit the location/threshold settings

- √ The homescreen is displayed.
- 1. Tap the [TruePON] button.
- 2. Press the [≡] key.
- 3. Tap the [More] button.
- 4. Tap the [LOCATIONS/THRESHOLDS] button.
- 5. Tap the desired test setup, press the [≡] key, and tap the [EDIT] button.
 - or –
 - To copy an existing setup, press the [≡] key, and tap the [COPY] button.
 - or –
 - To create a new setup, press the [≡] key, and tap the [ADD] button.

The desired setup is selected.
- 6. Adjust the setup settings:
 - Description
 - Thresholds: B, B+, C, C+, USER

Enabling the pass/fail evaluation

- √ The homescreen is displayed.
- 1. Tap the [TruePON] button.
- 2. Press the [≡] key.
- 3. Tap the [More] button.
- 4. Tap the [PASS/FAIL SETTINGS] button.
- 5. To enable or disable the pass/fail evaluations, tap on the desired button.

Changing the serial number format

- √ The homescreen is displayed.
- 1. Tap the [TruePON] button.
- 2. Press the [≡] key.
- 3. Tap the [More] button.
- 4. Tap the [ONU/ONT SER. NUMB. FORMAT] button.
- 5. To select an ONU/ONT serial number format, tap on the desired button.

Displaying the measurement view

- ✓ The homescreen is displayed.
- 1. Tap the [TruePON] button.
- 2. Press the [≡] key.
- 3. Tap the [More] button.
- 4. Tap the [Measurement Data] button.

Displaying the detailed measurement view

- ✓ The measurement data is displayed.
- 1. Tap on the desired result data.
- 2. Press the [≡] key.
- 3. Tap the [SHOW DETAILS] button.
The GTC Layer/PMD Layer view is displayed.

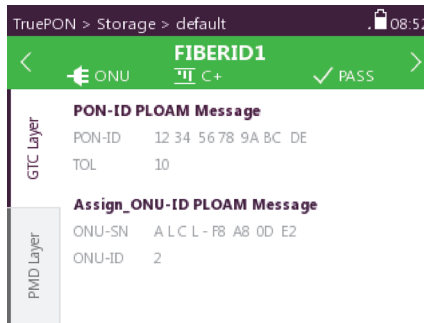

Fig. 14 GTC layer detail storage view

- 4. Tap on the arrows to navigate to the saved results.

6 PROBE/PCM OPERATION

General information

Dirty and/or damaged connectors are often the root cause of optical network problems. The Probe and PCM applications enable industry standard inspection and automated Pass/Fail testing with report generation of optical connectors/adapters in order to ensure industry standard fiber endface quality and cleanliness.

For best workflow efficiency, there are two variants of fiber microscopes available in the SmartClass™ Fiber family. The integrated Patch Cord Microscope (PCM), which is best suited for inspecting fiber endfaces of patch cords, and the external P5000i Digital Probe (see [“Accessories” on page 84](#)), which may be used either for bulkhead inspection or patch cord inspection. The shortest inspection time is achieved when using one of the OLP-88P models with an integrated PCM for patch cord inspection and a P5000i Digital Probe for bulkhead inspection. Both applications – Probe and PCM – behave essentially the same and are described together below.

Note: Only if a P5000i Digital Probe is connected to the instrument is the Probe application fully functional. Select an OLP-88P version in order to get PCM functionality.

Patch Cord Microscope (PCM)

The PCM is a microscope used to view and inspect patch cord (male) sides of fiber connectors.

In order to support a wide variety of fiber optic connectors, the PCM provides an exchangeable FMAE adapter. The dedicated QuickCapture key enables either instant triggering of a Pass/Fail test or freezing of the live image. For best workflow adaption, the key action is configurable. The dedicated Magnification Control key provides fast toggling between two microscope magnification levels, low magnification for high level inspection of the fiber endface, and high magnification for detailed inspection of the fiber endface.



Fig. 15 Patch cord microscope components

-
- | | |
|---|---------------------------|
| 1 | FMAE adapter |
| 2 | QuickCapture™ key |
| 3 | Focus Control |
| 4 | Magnification Control key |
-

FMAE series adapters for the PCM

SmartClass™ Fiber devices with the PCM use FMAE series adapters to ensure consistent and accurate inspection for a wide variety of connectors and applications. All PCM configurations ship with a 2.5 mm interface included. Kitted configurations may include additional FMAE adapters.

Features available with the P5000i Digital Probe

The P5000i Digital Probe is a portable handheld microscope used to view and inspect both the bulkhead (female) and patch cord (male) sides of fiber connectors, as well as other optical devices, such as transceivers.

The Digital Probe is specially designed to fit and operate comfortably and easily in-hand, allowing the user to inspect hard-to-reach connectors that are installed on the back side of patch panels or inside hardware devices. In order to support a wide variety of fiber optic connectors, the P5000i provides an exchangeable FBPT inspection tip. The dedicated QuickCapture key enables either instant triggering of a Pass/Fail test or freezing of the live image. For best workflow adaption, the key action is configurable. The dedicated Magnification Control key

provides fast toggling between two microscope magnification levels - low magnification for high level inspection of the fiber endface and high magnification for detailed inspection of the fiber endface.

The P5000i Digital Probe kit sold with the OLP-88 contains the standard barrel assembly (FBPP-BAP1), standard patch cord tips, and standard bulkhead tips. See "Accessories" on page 84.



Fig. 16 P5000i Digital Probe components

1	Inspection tip
2	Barrel assembly
3	QuickCapture™ key
4	Focus Control
5	Magnification Control key
6	USB 2.0 connector
7	1.83 m (6 ft) coil cable

FBPT series tips for the P5000i

The P5000i Digital Probe uses FBPT series inspection tips to ensure consistent and accurate inspection for a wide variety of connectors and applications. These connector-specific and universal inspection tips are interchangeable, which allows the P5000i Digital Probe to interface with different types of fiber connectors.

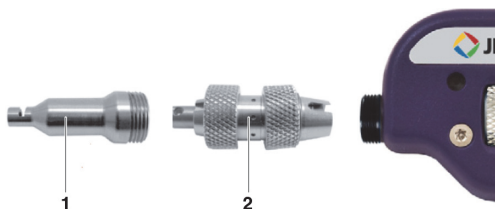

Fig. 17 FBPT series tips for the P5000i

1	Inspection tip
2	Barrel assembly

P5000i connection

The Probe application requires a P5000i Digital Probe in order to be fully functional (see the list of all accessories in “Accessories” on page 84).

1. Plug your P5000i into a USB port.
2. Connect the P5000i to the fiber being inspected.
3. Press the **[▲]** key, then tap the **[Probe]** button or use the arrows keys.

– or –

Press the **[≡]** key to toggle between the measurement view and the inspection view.

The P5000i will display the live view.

QuickCapture™ key

In order to support different workflows, the functionality of the QuickCapture™ key is configurable. Pressing the key will either freeze the live image or start a test:

Test	Pressing the key will automatically freeze the live image and perform a test.
Freeze	Pressing the key will automatically freeze the live image.

Camera mode

Set the QuickCapture™ key on the Digital Probe to get a live picture of the result.

Tip: Use the Focus Control key to adjust the focus of the image.

- ✓ The Digital Probe is connected to the instrument.
- ▶ To display the live view, tap the **[Probe]** button.

File toolbar

Saving a picture

It is possible to save the frozen picture from the Digital Probe.

1. Press the **[F]** key.
2. Edit the file name.
3. Tap the **[OK]** button.

File is saved in the preselected group.

Configuring the Digital Probe

1. Tap the [Probe] button.
2. Press the [≡] key to configure the Digital Probe according to the following description.

Brightness settings

1. Set the luminosity manually using the arrow keys.
 - or –
 - Tap the key [≡] > [Brightness] to tune the luminosity to the desired value.
2. Tap the [OK] button.
 - or –
 - To confirm, press the center key within the arrow keys.

Test mode

Launching a test of the connector and fiber end-face

See “Freeze mode” on page 45 for more information on commands available.

To launch the test with the predefined profile (see “Profile” on page 46):

1. With the P5000i Digital Probe, use the Focus Control key (see Fig. 16) to adjust the image quality and sharpness.
2. Press the [≡] key and tap the [Test] button.

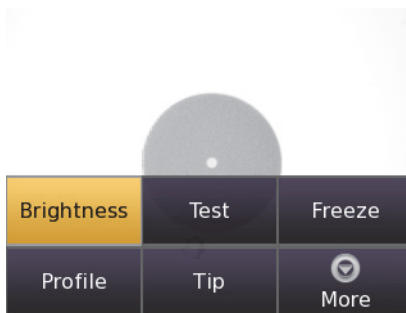

– or –

Press the QuickCapture™ key on the Digital Probe if the button action is set to **Test**.

When the test procedure terminates, the information shown on the display depends on the current overlay setting:

- ▶ Press the [≡] key and then the [Overlay] button to change the overlay view. Repeat the action until the desired view appears. *Three views can be displayed: without overlay, with colored edges, and colored edges with a legend.*

Overlay

A summary of test results is displayed at the upper right of the screen.

Zone A: represents the core zone. It is the area surrounding the core.

Zone B: represents the cladding zone. It surrounds the majority of the fiber cladding.

Zone C: represents the epoxy ring.

Zone D: represents the ferrule zone. It identifies a portion of the ferrule near and around the fiber.

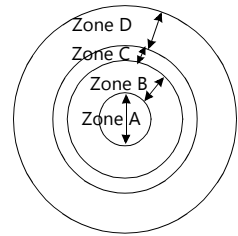

Note: To return to a Live image, press the QuickCapture™ key or press the [≡] key and tap the [Live] button to view both the live image and a test result simultaneously. If the test has been passed, the image has a green colored frame. If failed, the frame is red.

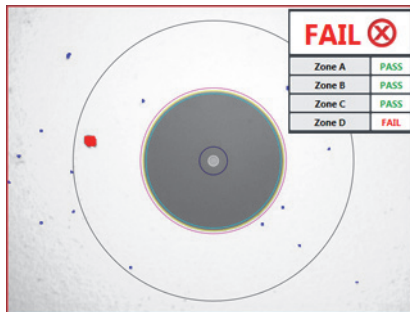

Fig. 18 Pass/Fail analysis – overlay view

Magnification Control

The Magnification Control allows you to modify the live display from high to low magnification and vice-versa. In the high magnification mode, automatic centering is available.

Picture selected: Live

Test	Allows you to launch a (new) test of the connector (see “ Launching a test of the connector and fiber end-face ” on page 43)
Freeze	Allows you to freeze the live image and to save it later on the disk. Once this key is pressed, the freeze image is automatically set to position 2.

Picture selected: Test

Save allows you to save the selected picture in the currently selected group in the disk of the instrument. Press the **[F5]** key, enter a name for the JPG file, and validate.

Overlay allows you to display or hide the limits of each zone and the defaults on an image from a test result.

Magnification Control allows you to switch all the images from Digital Probe test results from high to low magnification and vice-versa.

Saving the test result in a JPG file

Once the test has been performed and the result is displayed on the OLP-88 screen:

1. Press the **[F5]** key to save a JPG file of the test result in the currently active group on the OLP-88.
2. On the edition keypad, enter the name of the JPG file.
3. Press Enter to validate and save the document.

The file is saved in the current active group directory on the OLP-88.

Freeze mode

Once the image is acceptable (sharpness, luminosity are tuned correctly), you may freeze the picture. This feature allows you to store the resulting picture in order to compare it later to others or save it in a file. In Freeze mode, the picture has a blue colored frame.

Tip: Freezing a result does not store the picture in a file (see “[Saving a picture](#)” on page 42). The result will be lost if the instrument is shut off.

Depending on the QuickCapture™ key setting, this key allows you to freeze the picture or to start a test.

Profile

1. Press the [≡] key.
2. Tap the [Profile] button.
3. Tap the Profile which will be used for the test of the fiber connector:
 - E2000: Pass/Fail criteria for precision metal ferrule connectors.
 - Ribbon_: Pass/Fail criteria for single-mode and multi-mode connectors from IEC 61300-3-35 standard.
 - SM-UPC: Pass/Fail criteria for single-mode UPC connectors from IEC 61300-3-35 standard.
 - SM-APC: Pass/Fail criteria for single-mode APC connectors from IEC 61300-3-35 standard.
 - SM_PC: Pass/Fail criteria for single-mode PC connectors from IEC 61300-3-35 standard.
 - MM_: Pass/Fail criteria for multi-mode connectors from IEC 61300-3-35 standard.
 - SFP_: Pass/Fail criteria for small form-factor pluggables.

Profiles contain the analysis parameters from which Pass/Fail criteria are determined.

Tip

1. Press the [≡] key.
2. Tap the [Tip] button.
3. Select the tip set on the Digital Probe to connect fiber for inspection and tap on the tip set.

More

1. Press the [≡] key.
2. Tap the [More] button to view or change the storage location, settings and information of the Digital Probe.

7 MEMORY MANAGEMENT

General information

The OLP-88 allows you to save measured values and inspection images in a structured data memory and recall them as required. Data can also be downloaded via the USB interface to a PC for further evaluation.

In general there are two different modes available for data saving:

Link Data Mode

In case of applying different measurements e.g. PCM inspection and probe inspection on one test case, the saved results of all application are assigned to a dedicated project and FiberID. So, all measurements on one fiber performed with different applications can be easily assigned by the reporting software FiberChek PRO. The parameters for saving or reading data can be set only globally from the homescreen menu for all applications simultaneously.

Non Linked Mode

The result of a measurement application is saved under a free selectable file name (default file name is the determined incremental prefix) without any assignment to other measurements. Projects for saving and reading data can be set individually for each application.

To open the data menu:

- ✓ The homescreen is displayed.
- 1. Press the [≡] key.
- 2. Tap the [Data] button.

To view measurement data:

- ✓ The data menu is displayed.
- 1. Tap the [View Data] button.
- 2. Select an application to view all its saved data referring to the selected project.

To change the data settings:

Before you start your measurements you should determine a project and a prefix for your test scenario.

- ✓ The homescreen is displayed.
- 1. Press the [☰] key.
- 2. Tap the [Data] button.
- 3. Tap the [Data Settings] button.

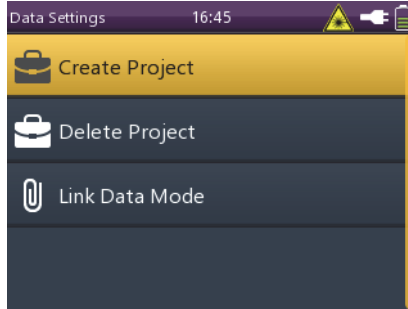

Fig. 19 Data Settings menu

To create a project:

- ✓ The homescreen is displayed.
- 1. Press the [☰] key.
- 2. Tap the [Data] button.
- 3. Tap the [Data Settings] button.
- 4. Tap the [Create Project] button to determine a new project.
The project appears in all available applications.

To delete a project:

- ✓ The homescreen is displayed.
- 1. Press the [☰] key.
- 2. Tap the [Data] button.
- 3. Tap the [Data Settings] button.
- 4. Tap the [Delete Project] button to delete a project with all assigned data.
The default project is always present and can't be deleted.

To use the Link Data Mode:

- 1. Select one of your predefined projects.
- 2. Determine a prefix for your test scenario. In case of saving data, this prefix, attached with an incremental index, is used as a file name.

To change the auto incremental index:

- ▶ Select [AutoInc Index Mode] to change the current used index attached to the prefix.

To select Link Data:

- ▶ Tap the [Link Data Mode] button to select or deselect the link data mode.

The data link mode is indicated with a paperclip symbol in the status bar

To select view linked data:

- ✓ This menu item is only visible, if **Link Data Mode** is selected.
- ▶ Displays the number of saved data for each individual application dedicated to an incremental prefix

To export CSV to an USB Stick:

- ▶ Tap the [Export CSV to USB Stick] button to export all saved data to USB drive in CSV format.

This file can be imported in an Excel sheet.

Selecting the project to save or display results

All saved results are assigned to a project. If the user didn't define a project, the default project, which is always present, is used.

In **Link Data Mode** the active project can be selected only from the homepage menu for all applications simultaneously.

The results and images are stored in the project most recently selected.

To select another project:

- ✓ An application is started.
 - ✓ The instrument is in the **Data** view.
 - ✓ **Link Data Mode** is not activated.
1. Press the [≡] key.
 2. Tap the [Project] button.
 3. Select a project.

Selected project is displayed.

Tip: The **Data** can be distinguished by the **Timestamp**.

Saving results

Results are stored simply by pressing the **[F]** key. Each time the key is pressed, the results will be stored.

Note: If an instrument with integrated patch cord microscope is connected to a Digital Probe, the images for the PCM and the Digital Probe will be stored in different folders.

To save current results successively:

- ✓ The instrument is in application mode.
- ✓ **Link Data Mode** is not activated.
- 1. Press the **[☰]** key.
- 2. Tap the **[More]** button.
- 3. Tap the **[Measurement Data]** button.
- 4. Press the **[☰]** key.
- 5. Tap the **[More]** button.
- 6. Tap the **[AutoInc FiberID]** button to set the checkmark.
- 7. Press the **[F]** key.

The Fiber ID edit menu is displayed:



- 8. Type in the **Fiber ID**.
- 9. Tap the **[OK]** button.
The measurement is stored.
- 10. Press the **[F]** key again every time you want to save an additional result value.
The display briefly shows the Fiber ID used.

Note: If the **Fiber ID** is not changed, the data set will be saved under the same title. Depending on the active application, the **Data** can be distinguished by the **Timestamp**.

Displaying stored results

To display the last results stored:

✓ The homescreen is displayed.

1. Press the [≡] key.
2. Tap the [Data] button.
A selection of the available applications is displayed.
3. Tap the desired application button.
– or –

✓ The instrument is in application mode.

1. Press the [≡] key.
2. Tap the [More] button.
3. Tap the [Measurement Data] button.
The measurement data of the currently selected project is displayed:

✓ Fiber ID	λ [nm]	Pow [dBm]
✓ BAKER.STREET.10	1310	LOW
✓ BAKER.STREET.10	1490	LOW
✓ BAKER.STREET.10	1550	LOW
FIBERID12	1310	LOW

To display the last results stored in Probe mode:

✓ The homescreen is displayed.

1. Tap the [Data] button.
2. Tap the [Probe] button.
Measurement data of the currently selected project is displayed.
3. Select the measurements you would like to view with the up or down arrow key and press the center key within the arrow keys to set a checkmark.
– or –

To set a checkmark, tap the desired measurements.

4. Press the [≡] key and tap the [View Selected] button to view the selected measurements.
5. Navigate through the selected measurements with the left or right arrow key.
6. Press the [↶] key if you wish to go back to the previous screen.

Using the Link Data Mode

In case of applying different measurements, PCM inspection and probe inspection on one test scenario, the saved results of all application are assigned to a dedicated project and FiberID. So, all measurements on one fiber performed with different applications can be easily assigned by the reporting software FiberChekPRO. The parameters for saving or reading data can be set only globally from the homescreen menu for all applications simultaneously.

To create a project:

- ✓ The homescreen is displayed.
 - 1. Press the [☰] key.
 - 2. Tap the [Data] button.
 - 3. Tap the [Data Settings] button.
 - 4. Tap the [Create Project] button.
 - 5. Type in a **Project Name**, e.g. "CO_MillerSt.16".
 - 6. Tap the [OK] button.
- The project is created.*

To activate the Link Data Mode:

- ✓ The homescreen is displayed.
 - ✓ The desired project is selected.
 - 1. Press the [☰] key.
 - 2. Tap the [Data] button.
 - 3. Tap the [Link Data Mode] button.
- A paperclip symbol appear in the status bar.*
- 4. Press the [↩] key to exit the menu.

To set your Link Data Mode parameters:

- ✓ The **Data** menu is displayed.
- 1. Set your Prefix, e.g. "CablePair".
- 2. Set your Index to the initial value, e.g. "1".

To start the application and save the measurements:

- ✓ The homescreen is displayed.
- ✓ Tap on the desired application.
- 1. Perform a measurement.
- 2. Press [☰] key.



Fig. 20 View linked data

The number of measurements saved for each application will be displayed.

Tapping the [OK] button, saves your recently measured data under the corresponding application. If all measurements done for your test scenario, please tap the [Increment ID] button to increment the index.

Clearing the memory

Each data set contains the wavelength, the relative power level and reference value or the absolute power level, the threshold set, and the date/time when it was stored.

You do not have to clear the entire memory to free up capacity. You can clear individual data or projects.

The OLP-88 has the following memory clear functions:

- **Delete Selected**
Clears the data of the selected measurement
- **Delete Project**
Clears all the measurements of the selected project

To clear the memory data:

- √ The instrument is in application mode.
- 1. Press the [≡] key.
- 2. Tap the [More] button.
- 3. Tap the [Measurement Data] button.
- 4. Select the measurement entries you want to delete.
- 5. Tap the [Delete Selected] button.
- 6. Press the [↶] key to exit from the menu.

Note: Now if you save results, they will be stored at the memory location of the last group displayed.

To clear all the data of a project:

√ The homescreen is displayed.

1. Press the [☰] key.
2. Tap the [Data] button.
3. Tap the [Delete Project] button.
4. Select the project you want to delete.

Press the center key within the arrow keys or press the [↩] key to cancel the delete process.

8 MAINTENANCE



⚠ WARNING

Dangerous voltage and invisible laser radiation

Maintenance or cleaning of the instrument while it is connected or operating may damage the instrument or injure you.

- ▶ Make sure that the instrument is switched off and disconnected from all power sources and optical radiation sources before maintenance or cleaning.

Cleaning the test port

It is a good idea to check that the optical connections are clean and clean them if necessary before starting measurements. Even very small dust particles on the end surfaces of the plugs or in the test adapters can adversely affect the accuracy of the measurement.

1. Switch off the instrument.
2. Remove the test adapter from the optical connection (["Mounting test adapters" on page 22](#)).
The plug end surface is now accessible.
3. Wipe off the plug end surface using a cotton bud soaked in isopropanol.
This cleaning method is very effective and leaves no residue.
4. Blow out the test adapter with clean compressed air (available in spray cans, e.g. anti-dust spray).

Note: Cover the optical connections with the dust cap whenever they are not in use. This prevents them from getting dirty.

Cleaning the instrument

If the instrument gets dirty through use, you can clean it using a soft cloth moistened with a mild solution of detergent.

NOTICE

Water and cleaning fluids

The instrument may be damaged or destroyed if water or cleaning fluids penetrate it.

- ▶ Make sure that water or cleaning fluids do not penetrate the instrument.
-

9 REMOTE CONTROL

Communication interface

The OLP-88 is equipped with a USB 2.0 (Micro-B) device interface for remote control via a PC. In order to operate the OLP-88 via remote control it has to be connected to a PC with a USB cable (see “Accessories” on page 84).



Fig. 21 USB cable for connection to a PC

The required driver files for the PC can be downloaded from <http://scf.updatemyunit.net>. See the Readme file provided with the driver package for installation guidance.

General operation

The main purpose of the remote control capability of the SmartClass™ Fiber family is to set and get Setup and Result values from an application. More complex remote control commands (called Extended Commands) providing extended application functionality are also available.

In general SmartClass™ Fiber allows multiple applications running on the system simultaneously. Hence there must be a way to select an application to which the remote control commands should be directed. Refer to “[Selecting an application](#)” on page 58 for more information.

In addition to the application-specific commands, there is a set of Generic Commands which control the instrument itself, independent from the currently selected application.

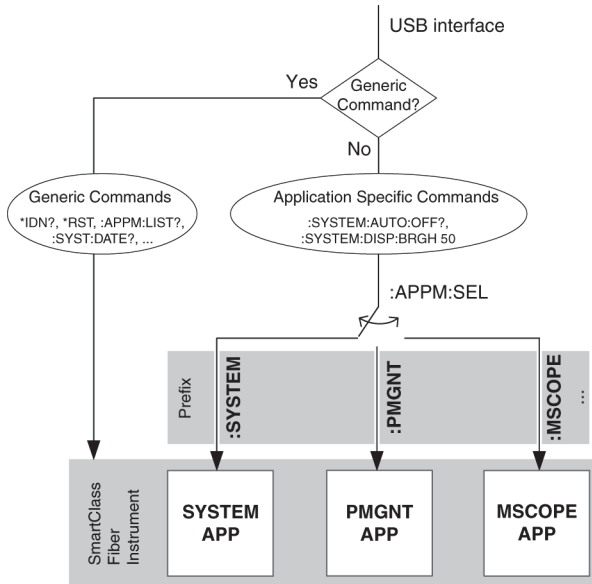

Fig. 22 Remote control block diagram

Selecting an application

In order to get to all available applications, to change the currently selected application, and to get to the currently selected application there is a set of application management commands. The application management commands are a subset of the Generic Commands and start with :APPM. The application management acts as a switch routing the remote control commands to the selected application. In order to identify an application each application has a unique application ID (<app_ID>) which will be used to set the switch.

For example send :APPM:SEL SYSTEM in order to select the system application.

In addition to selection via the application management commands, one can use a colon followed by the <app_ID> as a prefix to the remote command.

For example, add the prefix :SYSTEM to any system application command in order to communicate with the system application.

Note: Adding a prefix to a command has the same effect as selecting an application via an application management command. Hence, after using a prefix, the application corresponding to that prefix is the selected application.

Getting access to shared resources

On some instruments multiple applications share the same hardware resources. For that reason SmartClass™ Fiber instruments have the simple paradigm: the application which is visible on the GUI always has access to the shared resources. Regarding remote control, an application may not provide full functionality if it is not the currently visible application. In order to make sure the remote controlled application has full functionality, one should make the application visible by using the commands in the following table.

Command	Purpose
:APPM:LIST?	Provides a list of all application IDs separated by commas
:SYSTEM:APP:ID:VSBL <app_ID>	Makes the application corresponding to the application ID visible
:SYSTEM:APP:ID:VSBL?	Retrieves the ID of the currently visible application

Note: Applications that are not currently visible will return -221, "Settings conflict" when setting a Setup that affects shared resources, Results will return an invalid value 9.91E37 (NAN), and most of the Extended Remote Commands will return -100, "Command error".

Query the numerical setting range in the setup

The suffixes :MINV and :MAXV return the minimal and maximal allowed values:

e.g. :SYSTEM:DISP:BRGH:MINV? returns the value 10 and :SYSTEM:DISP:BRGH:MAXV? the value 100.

Command parameters and responses

The following table lists the parameter and response types used for remote control.

<NR1>	Integer value. Examples: 23, 90, 0
<NR2>	Real number. Examples: 23.45, 1.30
<NR3>	Exponential number. Examples: 4.3E-3, -8.9456E8, 123E-5
<NRf>	<NR1> <NR2> <NR3>
<BOOLEAN>	Boolean value. If the setting range is used as a response type, 0 and 1 are returned. Examples: 0, OFF, FALSE 1, ON, TRUE
<NAN>	Not a number. Indicates an invalid result. The returned value is 9.91E37.
<STRING>	IEEE488.2
<STRING_RESPONSE_DATA>	IEEE488.2

Commands

Overview

Generic commands

These commands are always used without a prefix.

```
*IDN?  
*OPT?  
*RST  
:APPM:LIST?  
:APPM:SEL  
:APPM:SEL?  
:APPM:VER?  
:SYST:DATE  
:SYST:DATE?  
:SYST:ERR?  
:SYST:TIME  
:SYST:TIME?
```

Probe application/PCM application

These commands are used with the prefix :MSCOPE (for Probe application, external microscope) or with the prefix :PCM (for PCM application, built-in microscope).

Results

```
:FQM:PERC?  
:FQM:PERC:MAX?  
:INSP:PASS?  
:INSP:PASS:ZONE:A? ... F?  
:INSP:ZONE:NUMB?
```

Setups

```
:APP:ID:VSBL  
:APP:ID:VSBL?  
:AUTO:CNTR  
:AUTO:CNTR?  
:CAPT:BTTN:MODE  
:CAPT:BTTN:MODE?  
:FQM:ENAB  
:FQM:ENAB?  
:FRZE:BUSY?  
:INSP:BUSY?  
:INSP:ERR?  
:INSP:PRF:NAME  
:INSP:PRF:NAME?  
:INSP:PRF:NAMES?  
:INSP:TBL:SHOW  
:INSP:TBL:SHOW?  
:INSP:TIP:NAME  
:INSP:TIP:NAME?  
:INSP:TIP:NAMES?  
:MAGN:HIG  
:MAGN:HIG?  
:MICR:BAD?  
:MICR:CON?  
:MICR:DET?  
:MICR:OPER:MODE  
:MICR:OPER:MODE?  
:OVL:SHOW  
:OVL:SHOW?  
:STOR:AUTO:INCR:ENAB  
:STOR:AUTO:INCR:ENAB?  
:STOR:AUTO:INCR:IDX  
:STOR:AUTO:INCR:IDX?  
:STOR:AUTO:INCR:PRFX  
:STOR:AUTO:INCR:PRFX?  
:STOR:AVLB?
```

:STOR:GRP:NAME
:STOR:GRP:NAME?
:STOR:GRP:NAMES?
:STOR:NAMES?
:STOR:NOTE
:STOR:NOTE?
:STOR:WR:BUSY?

Extended commands

:APP:FACT:DEF
:MICR:CAL:INFO?
:MICR:MODL:NAME?
:MICR:SER:NUMB?
:MICR:SW:VER?
:STOR:ALL:DEL
:STOR:DEL
:STOR:GRP:CREA
:STOR:GRP:DEL
:STOR:EVAL:TYPE?
:STOR:RD?
:STOR:RD:EVAL:XML?
:STOR:RD:FMAP?
:STOR:RD:IMG:HIG?
:STOR:RD:IMG:HIG:OVRL?
:STOR:RD:IMG:LOW?
:STOR:RD:IMG:LOW:OVRL?
:STOR:WR

TruePON application

These commands are used with the prefix :PONEXTENDED.

Results, setups, and extended commands

- Please visit the Viavi web site at <http://updatemyunit.net> for the latest operating manual (see also "Operating manual update" on page 8).

SYSTEM application

These commands are used with the prefix :SYSTEM.

Setups

```
:APP:ID:VSBL
:APP:ID:VSBL?
:AUTO:OFF
:AUTO:OFF?
:DISP:BRGH
:DISP:BRGH?
:DISP:OFF
:DISP:OFF?
:ETH:MAC:ADDR?
:IP:ADDR?
:IP:ADDR:STAT
:IP:ADDR:STAT?
:IP:GATE
:IP:GATE:STAT
:IP:GATE:STAT?
:IP:MASK
:IP:MASK:STAT
:IP:MASK:STAT?
:IP:MODE
:IP:MODE?
:LANG
:LANG?
:OPT:INST:BUSY?
:OPT:INST:ERR:LIST?
:OPT:INST:LIST?
:OPT:ULCK?
:STOR:AVLB?
```

Extended commands

```
:APP:FACT:DEF
```

PowerManagement application

These commands are used with the prefix :PMGNT.

Results

:BATT:CAP:PERC?

:BATT:TYPE?

:POW:SPLY:CON?

Setups

:STOR:AVLB?

Extended commands

:APP:FACT:DEF

Detailed description of the commands

Generic commands

Command string	Parameter type / Response type / Unit / Info
*IDN?	Returns the unique identification of the instrument. Response type: <STRING_RESPONSE_DATA> e.g. Viavi Solutions D. GmbH, OLP-88/01,A-0106,V03.30
*OPT?	Returns the installed software options.
*RST	Sets the parameters of all running applications to their default values. Calls :APP:FACT:DEF of all applications.
:APPM:LIST?	Provides a list of application IDs separated by commas. Response type: <STRING_RESPONSE_DATA>
:APPM:SEL <STRING>	Selects the application specified by the application ID provided. Valid values: All application IDs returned from :APPM:LIST?
:APPM:SEL?	Returns the application ID of the currently selected application.
:APPM:VER?	Returns the version of the remote control application.
:SYST:DATE	Sets the system date (yyyy,mm,dd). e.g. :SYST:DATE 2013,03,30
:SYST:DATE?	Returns the system date (yyyy,mm,dd). e.g. 2013,03,30
:SYST:ERR?	Returns content of error queue.
:SYST:TIME	Sets the system time (hh,mm,ss). e.g. :SYST:TIME 23,59,59
:SYST:TIME?	Returns the system time (hh,mm,ss). e.g. 23,59,59

Results for the Probe application/PCM application

Command string	Parameter type / Response type / Unit / Info
:FQM:PERC?	Focus quality result. 0 = Not calculated for the image. Response type: <NR1>
:FQM:PERC:MAX?	Focus quality highwater mark. Highest focus quality value recently observed. Response type: <NR1>
:INSP:PASS?	Pass/Fail result for the complete fiber. Response type: <BOOLEAN>
:INSP:PASS :ZONE:A? ... F?	Pass/Fail result for fiber zones A–F respectively, depending on the selection. Response type: <BOOLEAN>
:INSP:ZONE:NUMB?	Number of available inspection zones. Response type: <NR1>

Setups for the Probe application/PCM application

Command string	Parameter type / Response type / Unit / Info
:APP:ID:VSBL <STRING>	Makes the specified application visible (i.e. brings the specified application to foreground). Note: Full functionality is only available for the active application, so it may be important to know which application is active. Valid values: All application IDs returned by :APPM:LIST?.
:APP:ID:VSBL?	Returns the name of measurement application which is currently visible on the display. Response type: <STRING> See :APP:ID:VSBL command for more information.
:AUTO:CNTR <BOOLEAN>	Controls fiber center tracking for live video images in high-magnification mode. Default: TRUE
:AUTO:CNTR?	Returns TRUE if the fiber center tracking in live video is turned on. Response type: <BOOLEAN> See :AUTO:CNTR command for more information.
:CAPT:BTTN:MODE <NR1>	Controls the function of the probes capture button. Valid values: 0: Freeze 1: Test Default: 1
:CAPT:BTTN:MODE?	Returns which function the probes capture button has. Response type: <NR1> See :CAPT:BTTN:MODE command for more information.
:FQM:ENAB <BOOLEAN>	The Digital Probe calculates a focus quality metric for each video frame. If this flag is set to TRUE, the result is displayed as a focus bar on the screen. Deactivating this calculation can speed up video frame rate in some cases. Default: TRUE

Command string	Parameter type / Response type / Unit / Info
:FQM:ENAB?	Returns TRUE if the calculated focus quality metric for video frames is enabled. Response type: <BOOLEAN> See :FQM:ENAB command for more information.
:FRZE:BUSY?	Returns TRUE if an image is captured. After saving the image, the value is changed to FALSE. Response type: <BOOLEAN>
:INSP:BUSY?	Returns TRUE if the analysis of an image has been started. After analyzing the image, the value is changed to FALSE. Response type: <BOOLEAN>
:INSP:ERR?	Returns TRUE if the test of an image causes an error. Response type: <BOOLEAN>
:INSP:PRF:NAME <STRING>	Name of the selected inspection profile name. The first entry in the common profile names directory is used as default name. See :INSP:PRF:NAMES? command for more information.
:INSP:PRF:NAME?	Returns the name of the selected inspection profile. Response type: <STRING> See :INSP:PRF:NAME command for more information.
:INSP:PRF :NAMES?	Returns the names of all available inspection profiles (read from common (PCM and MSCOPE) profile directory).
:INSP:TBL:SHOW <BOOLEAN>	Shows or hides the result table for a tested image. Default: TRUE
:INSP:TBL:SHOW?	Returns TRUE if the result table for a tested image is displayed. See :INSP:TBL:SHOW command for more information.
:INSP:TIP:NAME <STRING>	Selects one tip out of the tip names map. See :INSP:TIP:NAMES? command for more information. Each time the tip names map changes, the tip name has to be updated.
:INSP:TIP:NAME?	Returns the name of the selected tip. Response type: <STRING> See :INSP:TIP:NAME command for more information.

Command string	Parameter type / Response type / Unit / Info
:INSP:TIP:NAMES?	Returns the names of all available tips that match both of the following conditions: <ul style="list-style-type: none"> The tip name and the name of an active calibration of the connected Digital Probe must be identical. See :MICR:CAL:INFO? command for more information. At least one entry in the INSP:PRF:NAMES list must support this kind of tip. Each time the active profile is changed, this map will be updated.
:MAGN:HIGH <BOOLEAN>	Sets the magnification of the Digital Probe. Default: FALSE
:MAGN:HIGH?	Returns TRUE if the magnification of the Digital Probe is high. Response type: <BOOLEAN> See :MAGN:HIGH command for more information.
:MICR:BAD?	Returns TRUE if the detected Digital Probe could not be initialized properly. Response type: <BOOLEAN>
:MICR:CON?	Returns TRUE if a Digital Probe is detected and the authorization as well as initialization tasks have finished successfully. Response type: <BOOLEAN>
:MICR:DET?	Returns TRUE if a Digital Probe is detected. Response type: <BOOLEAN>
:MICR:OPER:MODE <NR1>	Selects the operation mode of the Digital Probe. Valid values: 0 (Live image) 2 (Snapshot) 3 (Test) Default: 0
:MICR:OPER:MODE?	Returns the actual operation mode of the Digital Probe. Response type: <NR1> See :MICR:OPER:MODE command for more information.

Command string	Parameter type / Response type / Unit / Info
:OVRL:SHOW <BOOLEAN>	Displays or hides the overlay for a tested image. Default: TRUE
:OVRL:SHOW?	Returns TRUE if the overlay for a tested image is displayed. Response type: <BOOLEAN> See :OVERL:SHOW command for more information.
:STOR:AUTO:INCR :ENAB <BOOLEAN>	Enables the automatic increment feature. Default: TRUE
:STOR:AUTO:INCR :ENAB?	Returns TRUE if the automatic increment feature is enabled. Response type: <BOOLEAN> See :STOR:AUTO:INCR:ENAB command for more information.
:STOR:AUTO:INCR :IDX <NR1>	Sets the start index for the automatic increment feature. Valid range: 1 to maximum integer Default: 1
:STOR:AUTO:INCR :IDX?	Returns the current index for the automatic increment feature. Response type: <NR1> See :STOR:AUTO:INCR:IDX command for more information.
:STOR:AUTO:INCR :PRFX <STRING>	Sets the prefix for the automatic increment feature.
:STOR:AUTO:INCR :PRFX?	Returns the prefix for the automatic increment feature. Response type: <STRING> See :STOR:AUTO:INCR:PRFX command for more information.
:STOR:AVLB?	Returns whether the application can or cannot store measurements.
:STOR:GRP:NAME <STRING>	Sets the selected storage group name.
:STOR:GRP:NAME?	Returns the name of the currently selected storage group. Response Type: <STRING> See :STOR:GPR:NAME command for more information.

Command string	Parameter type / Response type / Unit / Info
:STOR:GRP:NAMES?	This setup contains the names of all available storage groups. The "default" group is always available.
:STOR:NAMES?	This setup contains the fiber IDs and internal IDs belonging to the group specified by :STOR:GRP:NAME.
:STOR:NOTE <STRING>	A user specific note which is stored with the measurement results.
:STOR:NOTE?	Returns the stored user note. Response Type: <STRING> See :STOR:NOTE command for more information.
:STOR:WR:BUSY?	Returns TRUE if a storage command is active. After saving the measurement the value FALSE will be returned. Response type: <BOOLEAN>

Extended commands for the Probe application/PCM application

Command string	Parameter type / Response type / Unit / Info
:APP:FACT:DEF	Sets all parameters of the application to their default values.
:MICR:CAL:INFO?	Returns the list of calibrations ("tips") of the connected Digital Probe. Example of a list: (sf = supported fibers) PCM: 2 active calibrations: [0], "Standard Tips (with BAP1)", sf=1;[1], "Ribbon Tips", sf=2
:MICR:MODL:NAME?	Returns the model of the connected Digital Probe. Usually: "FBP-P5000i"
:MICR:SER:NUMB?	Returns the serial number of the connected Digital Probe. For example "B1712-8740-399".
:MICR:SW:VER?	Returns the firmware version of the connected Digital Probe. For example "1.2.41.903".
:STOR:ALL:DEL	Deletes all measurement entries and groups. Creates a new empty "default" group. :STOR:GRP:NAME is set to default.
:STOR:DEL <STRING>, <STRING>, <STRING>	Deletes a dedicated measurement result specified by group (string1), fiber identifier (string2) and internal identifier (string3).

Command string	Parameter type / Response type / Unit / Info
:STOR:EVAL:TYPE? <STRING> , <STRING> , <STRING>	Returns "1" if a dedicated measurement result specified by group (string1), fiber identifier (string2), and internal identifier (string3) contains a Pass/Fail analysis. Otherwise it returns "0".
:STOR:GRP:CREA <STRING>	Creates an empty storage group. For example :PCM:STOR:GRP:CREA myGroupName
:STOR:GRP:DEL <STRING>	Deletes the storage group specified by string. For example :PCM:STOR:GRP:CREA default2. After deleting the currently selected group (see :STOR:GRP:NAME), the selection will be changed to "default" group. Any attempt to delete the "default" group will only delete the contents of this group.
:STOR:RD? <STRING> , <STRING> , <STRING>	Returns a string describing the measurement result specified by group (string1), fiber identifier (string2), and internal identifier (string3).
:STOR:RD:EVAL :XML? <STRING> , <STRING> , <STRING>	Returns the contents of a *.pfr.xml ("pfr" = "pass/fail result") file specified by group (string1), fiber identifier (string2), and internal identifier (string3). Special format: "#h:3104,696e7072cdcc"
:STOR:RD:FMAP? <STRING> , <STRING> , <STRING>	Returns the contents of a *.fmap.pgm.gz ("fmap.pgm.gz" = "feature map.portable gray map.gzip") file specified by group (string1), fiber identifier (string2), and internal identifier (string3). Special format: "#h:3104,696e7072cdcc"
:STOR:RD:IMG :HIGH? <STRING> , <STRING> , <STRING>	Returns the contents of a *.hm.jpg ("hm.jpg" = "high magnification.jpg") file specified by group (string1), fiber identifier (string2), and internal identifier (string3). Special format: "#h:10091,696e7072cdcc"
:STOR:RD:IMG:HIGH :OVRL? <STRING> , <STRING> , <STRING>	Returns the contents of a *.thm.jpg ("thm.jpg" = "test high magnification.jpg") file specified by group (string1), fiber identifier (string2), and internal identifier (string3). Special format: "#h:16100,696e7072cdcc"

Command string	Parameter type / Response type / Unit / Info
:STOR:RD:IMG:LOW? <STRING>, <STRING>, <STRING>	Returns the contents of a *.lm.jpg ("lm.jpg" = "low magnification.jpg") file specified by group (string1), fiber identifier (string2), and internal identifier (string3). Special format: "#h:14823,696e7072cdcc"
:STOR:RD:IMG:LOW :OVRL? <STRING>, <STRING>, <STRING>	Returns the contents of a *.tlm.jpg ("tlm.jpg" = "test low magnification.jpg") file specified by group (string1), fiber identifier (string2), and internal identifier (string3). Special format: "#h:16100,696e7072cdcc"
:STOR:WR <STRING>, <STRING>	Writes a dedicated measurement result specified by group (string1) and fiber identifier (string2). If the given group doesn't exist, it will be created. This command can take a few seconds to complete. Wait until ":STOR:WR:BUSY?" returns 0 before proceeding. This command creates up to seven files for up to seven components of the result. The seven ":STOR:RD...?" queries are used to read these result files. To create unique file names, this function automatically adds an internal index.

Results, setups, and extended commands for the TruePON application

- Please visit the Viavi web site at <http://updatemyunit.net> for the latest operating manual (see also "Operating manual update" on page 8).

Setups for the SYSTEM application

Command string	Parameter type / Response type / Unit / Info
:APP:ID:VSBL <STRING>	<p>Makes the specified application visible (i.e. brings the specified application to foreground).</p> <p>Note: Full functionality is only available for the active application, so it may be important to know which application is active.</p> <p>Valid values: All application IDs returned by :APPM:LIST?.</p>
:APP:ID:VSBL?	<p>Returns the application ID of the currently visible application.</p> <p>Response type: <STRING></p> <p>See :APP:ID:VSBL command for more information.</p>
:AUTO:OFF <NR1>	<p>Sets the time of inactivity after which the instrument automatically goes into standby mode.</p> <p>If an external power supply is connected, the instrument doesn't enter standby mode.</p> <p>Valid values: 0 (5 min) 1 (10 min) 2 (20 min) 3 (30 min) 4 (Never)</p> <p>Default: 2</p>
:AUTO:OFF?	<p>Returns the time of inactivity after which the instrument automatically goes into standby mode.</p> <p>Response type: <NR1></p> <p>See :AUTO:OFF command for more information.</p>
:DISP:BRGH <NR1>	<p>Sets the brightness of the display in percent.</p> <p>Valid range: 10 to 100</p> <p>Default: 50</p>
:DISP:BRGH?	<p>Returns the brightness of the display in percent.</p> <p>Response type: <NR1></p> <p>See :DISP:BRGH command for more information.</p>

Command string	Parameter type / Response type / Unit / Info
:DISP:OFF <NR1>	<p>In order to save power, the display switches off automatically after a predefined time of inactivity. If an external power supply is connected, the display doesn't switch off.</p> <p>Valid values: 0 (15 sec) 1 (30 sec) 2 (1 min) 3 (2 min) 4 (10 min) 5 (Never)</p> <p>Default: 5</p>
:DISP:OFF?	<p>Returns the time of inactivity after which the display automatically switches off.</p> <p>Response type: <NR1> See :DISP:OFF command for more information.</p>
:ETH:MAC:ADDR?	Returns the actual MAC address of the instrument.
:IP:ADDR?	<p>Returns the IP address which is currently valid for the instrument. In static mode, this setup corresponds to IP:ADDR:STAT; in DHCP mode, it is provided by the DHCP server. This setup is read-only.</p>
:IP:ADDR:STAT <STRING>	Sets the static mode IP address.
:IP:ADDR:STAT?	<p>Returns the static mode IP address.</p> <p>Response type: <STRING> See :IP:ADDR:STAT command for more information.</p>
:IP:GATE?	<p>Returns the IP gateway address which is currently valid for the instrument. In static mode, this setup corresponds to IP:GATE:STAT; in DHCP mode, it is delivered by the DHCP server. This setup is read-only.</p>
:IP:GATE:STAT <STRING>	Sets the static mode gateway address.
:IP:GATE:STAT?	<p>Returns the static mode gateway address.</p> <p>Response type: <STRING> See :IP:GATE:STAT command for more information.</p>

Command string	Parameter type / Response type / Unit / Info
:IP:MASK?	Returns the IP mask which is currently valid for the instrument. In static mode, this setup corresponds to IP:MASK:STAT; in DHCP mode, it is provided by the DHCP server. This setup is read-only.
:IP:MASK:STAT <STRING>	Sets the static mode IP mask.
:IP:MASK:STAT?	Returns the static mode IP mask. Response type: <STRING> See :IP:MASK:STAT command for more information.
:IP:MODE <NR1>	Selects if the IP address should be requested by DHCP or a static address should be used. Valid values: 0 (STATIC) 1 (DHCP) Default: 1
:IP:MODE?	Returns whether the instrument is set to a static or dynamic IP address. Response type: <NR1> See :IP:MODE command for more information.
:LANG <NR1>	Sets the user interface language. Valid values: 0 (en_US) 1 (de_DE) 2 (fr_FR) 3 (es_ES) 4 (zh_CN) 5 (zh_TW) Default: 0
:LANG?	Returns which user interface language is set. Response type: <NR1> See :LANG command for more information.
:OPT:INST:BUSY?	Returns TRUE if an installation is in progress. Response type: <BOOLEAN>

Command string	Parameter type / Response type / Unit / Info
:OPT:INST:ERR:LIST?	Returns a list of errors that occurred during installation of a license via USB flash drive or a key. List is cleared at the beginning of each installation.
:OPT:INST:LIST?	Returns a list of the software options installed via USB flash drive or a key. The list is cleared at the beginning of each installation.
:OPT:ULCK?	Returns all installed software options.
:STOR:AVLB?	Returns whether the application can or cannot store measurements. Always FALSE for SYSTEM application.

Extended commands for the SYSTEM application

Command string	Parameter type / Response type / Unit / Info
:APP:FACT:DEF	Sets all parameters of the application to their default values.

Results for the PowerManagement application

Command string	Parameter type / Response type / Unit / Info
:BATT:CAP:PERC?	Returns the remaining battery capacity in percent. If :BATT:TYPE == NOBATT 0 is returned.
:BATT:TYPE?	The instrument can work without an internal battery (NOBATT), with a rechargeable Lithium Ion battery (LIION), or with standard dry-cell batteries (DRYCELL). 0: No battery 1: Lithium Ion battery 2: Dry-cell batteries
:POW:SPLY:CON?	0: No external power supply is connected. 1: An external power supply is connected.

Setups for the PowerManagement application

Command string	Parameter type / Response type / Unit / Info
:STOR:AVLB?	Returns whether the application can or cannot store measurements. Always FALSE for PowerManagement application.

Extended commands for the PowerManagement application

Command string	Parameter type / Response type / Unit / Info
:APP:FACT:DEF	Sets all parameters of the application to their default values.

Error messages

Processing the program messages can cause the following error messages:

- 0, "No error"
- -310, "System error"
- -350, "Queue overflow"
- -360, "Communication error"
- -100, "Command error"
- -101, "Invalid character"
- -108, "Parameter not allowed"
- -109, "Missing parameter"
- -110, "Command header error"
- -112, "Program mnemonic too long"
- -113, "Undefined header"
- -220, "Parameter error"
- -221, "Settings conflict"
- -222, "Data out of range"
- -224, "Illegal parameter value"
- -254, "Media full"
- -290, "Memory use error"

10 SPECIFICATIONS

Functionality

General

Two-port through mode		X
Power measurements¹⁾		Downstream OLT signal (1490 nm)
		Upstream ONT signal (1310 nm burst mode)
		Downstream RF video signal (1550 nm)
G-PON data analysis²⁾	PON-ID option	ODN class detection and auto threshold setting
	PON-ID option	Power margin test with auto pass/fail analysis
	PON-ID option	In-service insertion loss test with auto pass/fail analysis
	PON-ID option	OLT identification
	X	Identification of ONT serial number ³⁾
	Alien-ONT option	Detection of alien ONTs ³⁾
Fiber inspection		
	Option	Via external P5000i Digital Probe
	OLP-88P version	Via integrated patch cord microscope

1) For B-PON (ITU-T G.983), E-PON (IEEE 802.3), G-PON (ITU-T G.984) signals

2) Optional with or G-PON signals according ITU-T G.984.3 Amendment 3

3) For G-PON signals according ITU-T G.984 (without PON-ID)

Technical specifications

FTTx measurements

Power measurements	Upstream 1310 nm ¹⁾	
	Power measurement range	-40 to +13 dBm
	Maximum permitted input level	17 dBm
	Spectral passband	1290 to 1330 nm
	Downstream 1490 nm	
	Power measurement range	-40 to +7 dBm
	Maximum permitted input level	9 dBm
	Spectral passband	1480 to 1500 nm
	RF video signals	
	Power measurement range	-40 to +26 dBm
	Maximum permitted input level	+27 dBm
	Spectral passband	1550 to 1560 nm
G-PON data analysis at 1490 nm		-30 to +7 dBm
Pass-through insertion loss²⁾		<1.5 dB
Power uncertainty²⁾		±0.5 dB
Calibrated wavelengths		1310, 1490, 1550 nm

1) Burst mode: -35 to +13 dBm

2) At 23 °C ±3 °C, at 1310/1490/1550 nm, at -7 dBm

General specifications

Display	High contrast 3.5" TFT color touchscreen
Display resolution	0.01 dB / 0.001 μ W
Live image	320 x 240 pixels, 8 bit gray, 10 fps
Measurement units	dB, dBm, W, pass/fail
ORL	> 60 dB
Fiber inspection (option)	Via external P5000i Digital Probe
Threshold sets	According ITU-T G.984.3, user specific-thresholds
Data memory	Up to 10.000 PON results (>1000 including inspection)
Data readout	Via client USB interface
Electrical interfaces	2 USB Type A, 1 USB Micro-B, Ethernet
Wireless connection	Wifi client
Power supply	Four-way power: NiMH, dry batteries, RBP2 LiIon Battery Pack, PS4 Universal AC/DC Power Supply 12 V with interchangeable wall plug for EU, UK, US and AU
Battery (Li-Ion Battery Pack)	3.7 V, 20 Wh
Battery life (Li-Ion Battery Pack)	> 12 h
Optical connectors	Interchangeable adapter SC/APC (optional: FC, ST and LC adapters)
Recommended recalibration interval	3 years
Size (H x W x D) OLP-88	208 x 112 x 64 mm (8.2 x 4.4 x 2.5 in)
Size (H x W x D) OLP-88P	208 x 153 x 64 mm (8.2 x 6.0 x 2.5 in)
Weight	750 g/850 g (1.6 lbs/1.85 lbs)
Operating temperature range	-5 °C to +45 °C (23 °F to 113 °F)
Storage temperature range	-25 °C to +55 °C (-13 °F to 131 °F)

EMC

EMC Standard Emission Immunity	IEC 61326:2002 Class B Equipment IEC 61326, Table 1
--------------------------------	---

Patch cord microscope specifications

Optical interface	FMAE LC duplex (many other adapters available)
Auto pass/fail analysis standards	IEC 61300-3-35 and custom limits
Live image	320 x 240 x 8 bit grey, 10 fps
Light source	Blue LED, 100.000+ hours life
Lighting technique	Coaxial
Magnification	Horizontal 740/370 μ m
field-of-view	low/high
	Vertical 550/275 μ m
External USB connected P5000i Digital Probe supported.	

PS4 Universal AC/DC Power Supply

Power supply type	FW 75550/12
Nominal line voltage range	100 to 240 VAC
Nominal line frequency range	47 to 63 Hz
Power consumption	Max. 8.5 W
Output	12 V DC / 2 A
Temperature range	0 to +40°C

Condensation – even occasional – is not tolerable.

11 ORDERING INFORMATION

OLP-88/OLP-88P stand alone unit

1310/1490/1550 nm	OLP-88 TruePON Tester	BN 2327/36
1310/1490/1550 nm	OLP-88P TruePON Tester with Patchcord Microscope	BN 2328/36

Included items

Stand alone units

- SmartClass™ Fiber instrument with APC connector
- 2 SC optical adapters
- Soft shoulder case for SmartClass™ Fiber + accessories
- Quick Start Manual and Safety Instructions
- Rechargeable RBP2 LiIon Battery Pack for SmartClass™ Fiber
- PS4 Universal AC/DC Power Supply for SmartClass™ Fiber (12 V)

Hardware options

WiFi option including USB WiFi adapter	BN 2327/90.11
P5000i Digital Probe with FiberChek PRO software and four tips	FBP-P5000i

Software options

OLP-88 Alien ONT detection SW-option	BN 2327/94.01
OLP-88 GPON-ID test SW-option	BN 2327/94.02

Accessories

PS4 Universal AC/DC Power Supply for SmartClass™ Fiber	BN 2305/90.01
RBP2 LiIon Battery Pack for SmartClass™ Fiber	BN 2305/90.02
Calibration report	BN 2305/90.03
UC4 hands free carrier for SmartClass™ Fiber	BN 2128/01
UC4P hands free carrier for SmartClass™ Fiber with PCM	BN 2128/02
SCASE2 soft shoulder case for SmartClass™ Fiber	BN 2128/03
USB cable USB-A to Micro USB	K 807

INDEX

A

- AC line plug adapter 20
- Auto-Off 24

B

- Batteries
 - Danger 18
 - Recharging 19
 - Replacing 18
 - Tips 19
- Battery operation 13
- Broadband
 - Mode 7
- Burst power measurements 7

C

- Cables, connecting 22
- Cleaning
 - Instrument 56
 - Optical connections 55
 - Test port 55
- Clearing the memory 53
- Common features 6
- Condensation 15
- Connecting optical cables 22
- Connector panel 5, 17
- Control panel 23

D

- Damages during shipping 15
- Default values 29
- Device overview 16
- Differences between the devices 6
- Display elements 24

E

- Environmental Management Program 87
- Environmental protection 20

- Extended commands 79
 - Probe/PCM 72
 - System 78

F

- Factory default 29
- Firmware update 30

L

- Laser safety 12
- Link Data Mode 24, 52

M

- Menu
 - Configuration 26
- Menu navigation 25

N

- Navigating in the menus 25

O

- On/Off 23
- Operation
 - Probe/PCM 39
 - TruePON, PONmeter 32
- Operation from AC power 20
- Overview 16

P

- Package contents 15
- Packing material 15
- Power mode 23
- Power supply 18
- PowerManagement 65, 79
- Probe/PCM 62
- Project
 - Create 52
 - Link measurement data 52
 - Select 52

Proper usage 11
PS4 Universal AC/DC Power Supply 13

R

Recovery 15
Recycling 20, 88
Remote Commands
 TruePON 64
Remote commands
 Error messages 80
 Generic commands 66
 PowerManagement 65, 79
 Probe/PCM 62, 67, 68, 72
 System 64, 75, 78
 TruePON 74
Results
 PowerManagement 79
 Probe/PCM 67
 TruePON 74
RoHS 89

S

Saving results 50
Selective power measurements 6
Setups 79
 Probe/PCM 68
 System 75
Shipping damage 15
Specifications 81
 FTTx measurements 81
 Functionality 81
 General 82
 Technical specifications 81
Symbols used 8
System 64

T

Test adapter, mounting 22
Through path 7
TruePON 64, 74
 Detail view 35
 General view 33
 Location/threshold settings 37
 Measurement view 38

Pass/fail evaluation 37
Serial number format 37

U

Update
 Firmware 30
 Operating manual 8

Viavi Environmental Management Program

Superb performance and high quality have always characterized Viavi datacom and telecom measurement technology products. In this same world-class tradition, Viavi has an established, proactive program of environmental management.

Environmental management is an integral part of Viavi's business philosophy and strategy requiring the development of long-term, productive solutions to problems in the key areas of economics, technology, and ecology.

A systematic environmental management program at Viavi is essential in regard to environmental policy and enhances cooperation between ourselves and our business partners.

The Viavi Environmental Management Program considers:

Product design and manufacture

Environmental restrictions and requirements are taken into account during planning and manufacture of Viavi products. This attention ranges from the raw materials and finished components selected for use and the manufacturing processes employed, through to the use of energy in the factory, and right on up to the final stages in the life of a product, including dismantling.

Hazardous materials

Viavi avoids or uses with care any hazardous or dangerous material in the manufacturing process or the end product. If the use of a dangerous material cannot be avoided, it is identified in product documentation and clearly labeled on the product itself.

Packaging materials

Preference is given to reusable or biodegradable single-substance packaging materials whenever possible.

Environmental management partnerships

Viavi encourages our customers and suppliers who take this responsibility seriously to join Viavi in establishing their own environmental management programs.

Recycling used products

This product complies with the European Union Waste Electrical and Electronic Equipment directive (WEEE), 2002/96/EC. This product should not be disposed of as unsorted municipal waste and should be collected separately and disposed of according to your national regulations.

In the European Union, all equipment purchased from Viavi after 2005-08-13 can be returned for disposal at the end of its useful life. Measuring systems affected by this can be recognized by the symbol on the right of a crossed-out trash can and a black bar. This symbol can be found either on the device or in the accompanying documents.



Contact your local Technical Assistance Center (TAC) for return and collection services available to you. If you would like specific information about the Viavi Environmental Management Program, please contact us at:

If you would like specific information about the Viavi Environmental Management Program, please contact us at www.viavisolutions.com.

The following page provides information with regard to the location of restricted hazardous substances within this equipment according to Chinese requirements.

As measuring equipment, this equipment is excluded from the European regulations for the restriction of hazardous substances (RoHS).

"中国RoHS"

《电子信息产品污染控制管理办法》（信息产业部，第39号）

附录 (Additional Information required for the Chinese Market only)

本附录按照"中国RoHS"的要求说明了有关电子信息产品环保使用期限的情况，并列出了产品中含有的有毒、有害物质的种类和所在部件。本附录适用于产品主体和所有配件。

环保使用期限：



本标识标注于产品主体之上，表明该产品或其配件含有有毒、有害物质（详情见下表）。

其中的数字代表在正常操作条件下至少在产品生产日期之后数年内该产品或其配件内含有的有毒、有害物质不会变异或泄漏。该期限不适用于诸如电池等易耗品。

有关正常操作条件，请参见产品用户手册。

产品生产日期请参见产品的原始校准证书。

有毒、有害物质的类型和所在部件

元器件 (Component)	有毒、有害物质和元素					
	铅 (Pb)	汞 (Hg)	镉 (Cd)	六价铬 (CR ⁶⁺)	多溴联苯 (PBB)	多溴二苯醚 (PBDE)
产品主体 (Main Product)						
印刷电路板组件 (PCB Assemblies)	X	O	O	O	O	O
内部配线 (Internal wiring)	O	O	O	O	O	O
显示器 (Display)	O	O	O	O	O	O
键盘 (Keyboard)	O	O	O	O	O	O
塑料外壳零件 (Plastic case parts)	O	O	O	O	O	O
配件 (Accessories)	O	O	O	O	O	O

O：代表该部分中所有均质材料含有的该有毒、有害物质含量低于SJ/T11363-2006标准的限值。
X：代表该部分中所有均质材料含有的该有毒、有害物质含量高于SJ/T11363-2006标准的限值。



North America
Latin America
China
Germany

+1 844-468 4284
+1 954 688 5660
+86 21 6859 5260
+49 7121 86 0

Viavi product specifications and descriptions in
are subject to change without notice.

© 2015.12