



mA-6806
Vector Signal Transceiver
Operation Manual



mA-6806
Vector Signal Transceiver
Operation Manual
Rev. 502



VIAVI Solutions
1-844-GO-VIAVI
www.viavisolutions.com

Notice

Every effort was made to ensure that the information in this manual was accurate at the time of printing. However, information is subject to change without notice, and VIAVI reserves the right to update content of this manual, or to provide an addendum to this manual, with information not available at the time that this manual was created.

Copyright/Trademarks

© Copyright 2024 VIAVI Solutions Inc. All rights reserved. No part of this guide may be reproduced or transmitted, electronically or otherwise, without written permission of the publisher. VIAVI Solutions and the VIAVI logo are trademarks of VIAVI Solutions Inc. (“VIAVI”).

AXIe is a registered trademark of the AXIe Consortium.

Signal WorkShop™ is a trademark of VIAVI Solutions.

Copyright Release

Reproduction and distribution of this guide is authorized for US Government purposes only.

Patent Information

Patented as described at www.viavisolutions.com/patents.

Terms and Conditions

Specifications, terms, and conditions are subject to change without notice. The provision of hardware, services, and/or software are subject to VIAVI’s standard terms and conditions, available at www.viavisolutions.com/en-us/corporate/legal/terms-and-conditions.

Warranty Information

Warranty information for this product is available on the VIAVI website at <https://www.viavisolutions.com/en-us/warranty-information>.

DFARS Statement

If software is for use in the performance of a U.S. Government prime contract or subcontract, software is delivered and licensed as “Commercial Computer Software” as defined in DFAR 252.227-7014 (Feb 2014), or as a “Commercial Item” as defined in FAR 2.101(a) or as “Restricted Computer Software” as defined in FAR 52.227-19 (Dec 2007) or any equivalent agency regulation or contract clause. Use, duplication or disclosure of Software is subject to VIAVI Solutions' standard commercial license terms, and non-DOD Departments and Agencies of the U.S. Government will receive no greater than Restricted Rights as defined in FAR 52.227-19(c)(1-2) (Dec 2007). U.S. Government users will receive no greater than Limited Rights as defined in FAR 52.227-14 (June 1987) or DFAR 252.227-7015 (b)(2) (November 1995), as applicable in any technical data.

Declaration of Conformity

VIAVI recommends keeping a copy of the Declaration of Conformity that shipped with the unit with the device at all times.

Industry Canada Requirements

This device complies with Industry Canada's license-exempt RSSs. Operation is subject to the following two conditions: 1) This device may not cause interference; and, 2) This device must accept any interference, including interference that may cause undesired operation of the device.

Le présent appareil est conforme aux CNR d'Industrie Canada applicables aux appareils radio exempts de licence. L'exploitation est autorisée aux deux conditions suivantes: 1) l'appareil ne doit pas produire de brouillage; et, 2) l'utilisateur de l'appareil doit accepter tout brouillage radioélectrique subi, même si le brouillage est susceptible d'en compromettre le fonctionnement.

EU WEEE and Battery Directives

This product, and the batteries used to power the product, should not be disposed of as unsorted municipal waste and should be collected separately and disposed of according to your national regulations.

VIAVI has established a take-back processes in compliance with the EU Waste Electrical and Electronic Equipment (WEEE) Directive, 2012/19/EU, and the EU Battery Directive, 2006/66/EC.

Instructions for returning waste equipment and batteries to VIAVI can be found in the WEEE section of [VIAVI's Standards and Policies web page](#).

If you have questions concerning disposal of your equipment or batteries, contact the VIAVI WEEE Program Management team at WEEE.EMEA@VIAVISolutions.com.

EU REACH

Article 33 of EU REACH regulation (EC) No 1907/2006 requires article suppliers to provide information if a listed Substances of Very High Concern (SVHC) is present in an article above a certain threshold.

For information on the presence of REACH SVHCs in VIAVI products, see the Hazardous Substance Control section of [VIAVI's Standards and Policies web page](#).

EU CE Marking Directives (LV, EMC, RoHS, RE)

This product conforms with all applicable CE marking directives. Please see EU Declaration of Conformity for details.

EMC Directive Compliance

This product was tested and conforms to the EMC Directive, 2014/30/EU for electromagnetic compatibility.

California Proposition 65

California Proposition 65, officially known as the Safe Drinking Water and Toxic Enforcement Act of 1986, was enacted in November 1986 with the aim of protecting individuals in the state of California and the state's drinking water and environment from excessive exposure to chemicals known to the state to cause cancer, birth defects or other reproductive harm.

For the VIAVI position statement on the use of Proposition 65 chemicals in VIAVI products, see the Hazardous Substance Control section of [VIAVI's Standards and Policies web page](#).

Korea Certification

<p>A급 기기 (업무용 방송통신기자재)</p> <p>Class A Equipment (Industrial Broadcasting & Communications Equipment).</p>	<p>이 기기는 업무용(A급) 전자파적합기기로서 판매자 또는 사용자는 이 점을 주의하시기 바라며, 가정외의 지역에서 사용하는 것을 목적으로 합니다.</p> <p>This equipment is Industrial (Class A) electromagnetic wave suitability equipment and seller or user should take notice of it, and this equipment is to be used in the places except for home.</p>
---	---

Notice:

The information provided in this statement is intended for informational purposes only and is not intended to be a representation or warranty of any kind, nor is it intended to modify in any way the terms and conditions of any agreement between your company and VIAVI, or the rights of either party arising therefrom.



Table of Contents

	Safety and Compliance Information	6-iii
Chapter 1	Overview of the mA-6806	
	About the mA-6806	1-2
	Features and Capabilities	1-2
	Principles of Operation	1-3
	Hardware Components	1-3
	Theory of Operation	1-3
	Module Firmware	1-4
Chapter 2	mA-6806 Connectors	
	mA-6806 Connectors	2-2
	Trigger Connectors (1:4)	2-2
	RF Input/Output Connectors	2-3
	RF Output Connector (5)	2-3
	RF Duplex Connector (6)	2-3
	RF Input Connector (7)	2-3
Chapter 3	mA-6806 Setup and Installation	
	Upon Receipt	3-2
	Unpack the Device	3-2
	Verify Contents	3-2
	Inspect the Device	3-2
	Module Installation	3-3
	Module Operation Verification Procedure	3-3
Chapter 4	mA-6806 Operation and Control	
	Module Software/Drivers	4-2
	Module Power On/Off Procedures	4-2
	Power On Procedure	4-2
	Power Off Procedure	4-3

Module Control and Operation	4-3
mA-6806 Web Browser UI	4-3
Chassis Web Browser UI	4-3
VST UI Client	4-4
External Software Applications	4-4
VST Network Settings	4-5
VST Default IP Address	4-5
Locate VST IP Address	4-6
mA-6806 Network Mode	4-8
Configure VST Network Mode of Operation	4-8
Emergency IP recovery	4-10
Chapter 5 mA-6806 Web Browser UI	
Introduction	5-2
Recommended Browsers	5-2
Open the VST Web UI	5-2
VST Web UI Components	5-3
Web UI Pages	5-4
VST Networking Page	5-4
Self Test Page	5-5
Chapter 6 VST UI Client	
Managing Software	6-2
VST UI Client Distribution	6-2
Installing Software	6-2
Updating Software	6-2
Software Version Information	6-3
VST UI Overview	6-4
Introduction	6-4
Opening the VST UI Client	6-4
VST UI Client Layout	6-7
Application Title Bar	6-7
VST UI Display Area	6-8
UI Control and Operation	6-9
VST Receiver	6-10
Receiver Staging Area	6-10
Receiver UI Components	6-11
Receiver Functions	6-14
VST Generator	6-23
Generator Staging Area	6-23
Generator UI Components	6-24
Generator Functions	6-29
Trigger Panel	6-30
Normalize Function	6-32
Using the VST	6-35

	Receiver Functions	6-35
	Generator Functions	6-35
	Using Markers	6-36
Chapter 7	mA-6806 Care and Maintenance	
	Maintaining the Device	7-2
	Storing the Device	7-2
	Visual Inspections	7-2
	External cleaning	7-3
	Firmware/Software Updates	7-3
	Updating Firmware/Software	7-3
	VST Self Test Procedure	7-4
	Module Removal/Installation Procedures	7-5
	Removing the Module	7-5
	Module Installation Procedure	7-6
	Shipping the mA-6806	7-8
	Return Authorization (RA)	7-8
	Tagging the Device	7-8
	Shipping Containers	7-8
	Freight Costs	7-8
	Packing Procedure	7-9
Chapter 8	Firmware and Software Upgrade Procedure	
Appendix A	mA-6806 Safety and Compliance Specifications	
	Unit Specifications	A-2
	Environmental Specifications	A-2
	Electrical Specifications	A-3
	Regulatory Standards and Compliance	A-3
Appendix B	Ranger Manual Validation Test Procedure	
Chapter C	Glossary	

This page intentionally left blank.



List of Figures

Figure 1-1	mA-6806 AXIe 6 GHz Vector Signal Transceiver Module	1-2
Figure 2-1	mA-6806 Connectors	2-2
Figure 2-2	mA-6806 Block Diagram	2-5
Figure 2-3	mA-6806 ICM Block Diagram	2-6
Figure 2-4	mA-6806 RF Combiner Block Diagram.	2-7
Figure 2-5	mA-6806 RF Receiver Block Diagram	2-8
Figure 2-6	mA-6806 RF Generator Block Diagram	2-9
Figure 4-1	Local Host Web UI homepage	4-6
Figure 4-2	Chassis Web UI Networking Page	4-7
Figure 4-3	Emergency IP recovery 1	4-11
Figure 4-4	Emergency IP recovery 2	4-12
Figure 4-5	Emergency IP recovery 3	4-12
Figure 5-1	VST Web UI Home Page	5-3
Figure 5-2	VST Networking Page.	5-4
Figure 5-3	VST Self Test Page	5-5
Figure 6-1	VST UI Client About Window	6-3
Figure 6-2	VST UI Client Launch Window	6-5
Figure 6-3	Demo Mode - Initial View	6-5
Figure 6-4	VST UI Client Connection Dialog Window	6-6
Figure 6-5	Hardware Mode - Title Bar	6-7
Figure 6-6	Simulation Mode - Title Bar.	6-7
Figure 6-7	VST Generator/Receiver UI Layout	6-8
Figure 6-8	Example: Receiver Recorder Screen	6-10
Figure 6-9	Recorder Function Toolbar	6-11
Figure 6-10	Receiver Functions Menu	6-13

Figure 6-11	Receiver Setting Panel	6-14
Figure 6-12	Receiver Trigger Controls and Settings.	6-16
Figure 6-13	Receiver Time Plot Panel	6-17
Figure 6-14	Receiver Spectrum Plot Panel	6-18
Figure 6-15	Time Plot with Markers Enabled	6-19
Figure 6-16	Marker Measurement Bar (Time Plot)	6-20
Figure 6-17	Marker Measurement Bar (Spectrum Plot)	6-20
Figure 6-18	VST UI Client About Window.	6-22
Figure 6-19	Example: Generator Continuous Wave (CW) Mode	6-23
Figure 6-20	Example: Generator Waveform Player Mode	6-24
Figure 6-21	Continuous Wave (CW) Function Toolbar	6-25
Figure 6-22	Generator Functions Menu	6-26
Figure 6-23	Waveform Player Controls and Settings	6-27
Figure 6-24	Generator Function Settings Panel	6-29
Figure 6-25	Generator Function Trigger Panel	6-30
Figure 6-26	Accessing Normalize Controls and Settings	6-32
Figure 6-27	Spot Normalize Controls and Settings	6-33
Figure 6-28	Full Normalize Controls and Settings	6-34
Figure 7-1	Securing Latch - Locked Position	7-7
Figure 7-2	Securing Latch - Unlocked Position	7-7
Figure 7-3	Securing Latch - Unlocked and Unlatched	7-7



List of Tables

- Table A-1 mA-6806 Physical specifications A-2
- Table A-2 Operating and storage environment A-2
- Table A-3 Power Requirements A-3
- Table A-4 Maximum Input Level A-3
- Table A-5 Compliance Standard A-3
- Table A-6 EMC Compliance A-3
- Table A-7 Safety Standards A-3

This page intentionally left blank.



Preface

This preface explains how to use this manual. Topics discussed include the following:

- Purpose and Scope ii
- Intended Audience ii
- Product Nomenclature ii
- Related Information ii
- Contact Information iii
- Safety Hazards iv
- Equipment Usage vii
- Electrostatic Discharge (ESD) vii
- Case/Cover Removal vii
- Ventilation Requirements viii
- Electromagnetic Interference (EMI) ix

Purpose and Scope

This document contains safety information and information for installing and operating the mA-6806 Vector Signal Transceiver (VST). Refer to the mA-1302/mA-1305 AXIe Chassis Operation Manual for Chassis installation and operating instructions.

Intended Audience

This manual is intended for personnel who are familiar with AXIe systems and associated equipment and terminology.

Product Nomenclature

The terms Transceiver, VST, module and device are used to refer to the mA-6806 Vector Signal Transceiver (VST) module.

The term VST Web UI is used to refer to the mA-6806 AXIe Vector Signal Transceiver Web Browser User Interface.

The term VST UI Client is used to refer to the mA-6806 AXIe Vector Signal Transceiver User Interface Client.

Related Information

This document and other Configurable Modular Platform (CMP) publications can be found on the VIAVI website at <https://www.viavisolutions.com/en-us/products/modular-axie>.

The following publications are referenced in this document:

- mA-1302/mA-1305 AXIe Chassis Operation Manual, #141171

Contact Information

Contact the Technical Assistance Center (TAC) for technical support or with any questions regarding this or other VIAVI products.

- Phone: 1-844-GO-VIAVI

International customers please refer to the VIAVI website link below for a service location in your area.

<https://www.viavisolutions.com/en/services-and-support/support/technical-assistance>

Safety and Compliance Information

Conventions

The following symbols and markings are used throughout documentation and on the Chassis.

Table 1 Safety Conventions





	This symbol indicates a note that includes important supplemental information or tips related to the main text.
	This symbol represents a general hazard. It may be associated with either a DANGER, WARNING, CAUTION or ALERT message. Refer to accompanying information and/or documentation.
	This symbol indicates a toxic hazard. Item should only be handled by Qualified Service Personnel. Dispose of item in accordance with local regulations.
	This symbol indicates an item is sensitive to Electrostatic Discharge (ESD). An item identified as ESD sensitive should only be handled by Qualified Service Personnel.
	This symbol indicates the item meets the requirements of the applicable European Directives.

Table 2 Safety Definitions

Term	Definition
CAUTION	Identifies conditions or activities that, if ignored, can result in equipment or property damage, e.g., Fire.
Mise en Garde	Identifiez les conditions ou les activités qui, si ignorées, peuvent entraîner des dommages à l'équipement ou aux biens, p. ex. un incendie.
WARNING	Identifies conditions or activities that, if ignored, can result in personal injury or death.
Avertissement	Identifiez les conditions ou les activités qui, si ignorées, peuvent entraîner des blessures personnelles voire mortelles.

Safety Hazards

Toxic Hazards



WARNING

Some of the components used in this device may include resins and other materials which give off toxic fumes if incinerated. Dispose of such items appropriately.

Avertissement

Certains des composants utilisés dans cet appareil peuvent comprendre des résines et d'autres matériaux qui produisent des émanations toxiques lorsqu'ils sont incinérés. Éliminez adéquatement de tels éléments.

Beryllia



Beryllia (beryllium oxide) is used in the construction of some of the components in this equipment.

This material, when in the form of fine dust or vapor and inhaled into the lungs, can cause a respiratory disease. In its solid form, as used here, it can be handled safely, however, avoid handling conditions which promote dust formation by surface abrasion.

Use care when removing and disposing of these components. Do not put them in the general industrial or domestic waste or dispatch them by post. They should be separately and securely packed and clearly identified to show the nature of the hazard and then disposed of in a safe manner by an authorized toxic waste contractor.

Beryllium Copper



CAUTION

Some mechanical components within this instrument are manufactured from beryllium copper. Beryllium copper represents no risk in normal use. The material should not be machined, welded or subjected to any process where heat is involved.

Beryllium copper must NOT be disposed of by incineration. Beryllium copper must be disposed of as “special waste” per local regulations.

Electrical Hazards

Grounding the Module

The Chassis is provided with a protective grounding lead that conforms with IEC Safety Class I. The supply lead must always be connected to the power supply via a grounded contact in order to maintain the grounding protection. The Chassis must be properly grounded to prevent damage to the device from electrostatic discharge (ESD).



WARNING

Improper grounding of equipment can result in electrical shock. To ensure proper grounding, this device should only be connected to a grounded AC Power Supply.

Avertissement

La mise à la terre inadéquate de l'équipement peut entraîner un choc électrique. Pour s'assurer d'une mise à la terre adéquate, cet appareil doit seulement être branché à une alimentation électrique CA mise à la terre.

Residual Current



WARNING

The supply filter contains capacitors that may remain charged after the device is disconnected from the power supply. The residual energy is within the approved safety requirements, however, a slight shock may be felt if the plug pins are touched immediately after removal.

Avertissement

Le filtre d'alimentation contient des condensateurs qui peuvent rester chargés une fois l'appareil débranché de l'alimentation électrique. L'énergie résiduelle est dans les limites des exigences de sécurité approuvées. Par contre, un léger choc électrique peut être ressenti si l'on touche les broches de la prise immédiatement après son débranchement.

Input Overload

Refer to product labeling and product data sheet for maximum input ratings.



CAUTION

Do not overload input connectors. Refer to product Safety and Compliance Specifications or the product data sheet for maximum input ratings.

Mise en Garde

Identifiez les conditions ou les activités qui, si ignorées, peuvent entraîner des dommages à l'équipement ou aux biens, p. ex. un incendie.

Equipment Usage

This device is designed and tested to comply with the requirements of 'IEC/EN 61010-1, 3rd Edition Safety Requirements for Electrical Equipment for Measurement, Control and Laboratory Use' for Class I portable equipment and is for use in a pollution degree 2 environment.



WARNING

Operating this device in a manner not specified in accompanying documentation may impair the safety protection built into the device.

Avertissement

Utiliser cet appareil de manière non spécifiée dans la documentation d'accompagnement peut nuire au dispositif de protection de sécurité intégré dans l'appareil.

Electrostatic Discharge (ESD)



CAUTION

Modules are ESD sensitive and should only be installed, removed and/or serviced by Qualified Service Personnel.

Mise en Garde

Les modules sont sensibles aux DES et ils doivent seulement être installés, enlevés ou entretenus par du personnel de service qualifié.

Case/Cover Removal



CAUTION

This device does not contain user serviceable parts. Servicing should only be performed by Qualified Service Personnel.

Mise en Garde

Cet appareil ne contient pas de pièces pouvant être entretenues par l'utilisateur. L'entretien doit seulement être effectué par du personnel de service qualifié.

Ventilation Requirements

The Chassis is cooled by the unit's internal fans which pull air across the modules from right to left. Failure to provide proper ventilation may result in damage to the Chassis and any modules installed in the Chassis. Observe the following precautions when operating the Chassis:



CAUTION

Do not operate the Chassis with empty slots. Install Filler modules in empty slots to ensure proper airflow through the Chassis.

Do not obstruct air flow to the air vents.

Do not place the Chassis on or close to other heat-generating equipment.

Mise en Garde

N'utilisez pas le châssis avec des fentes vides. Installez des modules de remplissage dans les fentes vides afin d'assurer un écoulement d'air adéquat dans le châssis.

N'obstruez pas l'écoulement d'air vers les événements.

Ne placez pas le châssis sur ou près de tout autre équipement générant de la chaleur.

Electromagnetic Interference (EMI)

This product complies with Part 15 of the FCC Rules for a Class A device. Operation is subject to the following two conditions: (1) this product may not cause harmful interferences, and (2) this product must accept any interferences received, including interference that may cause undesired operation.

These limits are designed to provide reasonable protection against harmful interference in a residential installation. This product generates, uses, and can radiate radio frequency energy and, if not installed and used in accordance with the instructions, may cause harmful interference to radio communications. However, there is no guarantee that interference will not occur in a particular installation.

If this product does cause harmful interference to radio or television reception, which can be determined by turning the equipment off and on, the user is encouraged to try to correct the interference by one or more of the following measures:

- Reorient or relocate the receiving antenna.
- Increase the separation between the equipment and receiver.
- Connect the equipment into an outlet on a circuit different from that to which the receiver is connected.
- Use properly shielded and grounded cables and connectors in order to meet FCC emission limits.



CAUTION

Signal generators can be a source of Electromagnetic Interference (EMI) to communication receivers. Some transmitted signals can cause disruption and interference to communication services out to a distance of several miles. Users of this equipment should scrutinize any operation that results in radiation of a signal (directly or indirectly) and should take necessary precautions to avoid potential communication interference problems.

Mise en Garde

Les générateurs de signaux peuvent constituer une source d'interférences électromagnétiques (IME) pour les récepteurs radio. Certains signaux émis peuvent provoquer des interférences et des interruptions des communications sur une distance de plusieurs kilomètres. Les utilisateurs de cet équipement doivent examiner soigneusement tout fonctionnement provoquant le rayonnement d'un signal (direct ou indirect) et ils doivent prendre les dispositions nécessaires afin d'éviter des problèmes potentiels d'interférences sur les communications.

This page intentionally left blank.

Overview of the mA-6806

This chapter provides a general description of the mA-6806 Vector Signal Transceiver (VST) module. Topics discussed in this chapter include the following:

- [About the mA-6806](#) 1-2
- [Features and Capabilities](#) 1-2
- [Principles of Operation](#) 1-3
- [Module Firmware](#) 1-4

About the mA-6806

The mA-6806 module is an AXIe module that combines the measurement capabilities of a Vector Signal Analyzer (VSA) with the arbitrary waveform playback functions of a Vector Signal Generator (VSG).

Figure 1-1 mA-6806 AXIe 6 GHz Vector Signal Transceiver Module



The mA-6806 supports capture from and playback of I/Q data to the module's on-board 4 GB memory as well as real-time streaming of the full bandwidth I/Q data via the module's backplane PCIe interface. Remote applications are supported via the Chassis Gigabit Ethernet (GbE) interface. The mA-6806 contains a dedicated RF Input and RF Output connector as well as an RF Duplex port that support full or half duplex modes of operation.

Features and Capabilities

The following are key features and capabilities of the mA-6806:

- Frequency range 1 MHz - 6 GHz
- Maximum bandwidth 160 MHz (200 MHz usable)
- High spurious free dynamic range
- Selectable low noise amplifier
- Harmonic and pre-select filtering
- Hardware digital downconverter
- Hardware resampling engine
- High power full- or half-duplex operation
- Agile list mode operation
- I/Q streaming via PCI Express

Refer to the product data sheet for a complete list and detailed description of product features, capabilities and performance specifications.

Principles of Operation

This section details the various components of the VST. Refer to [Figure 2-2 on page 2-5](#) for a high-level block diagram of the mA-6806.

Hardware Components

The mA-6806 VST is a full width, single height AXIe tray that contains the following hardware components:

- RF Generator Assembly
- RF Receiver Assembly
- RF Combiner Assembly
- Instrument Carrier Module (ICM)

Theory of Operation

See [Figure 2-2 on page 2-5](#) for a block diagram of the mA-6806.

RF Receiver Assembly

See [Figure 2-5 on page 2-8](#) for a block diagram of the mA-6806's RF Receiver Assembly.

For frequency ranges from 70 MHz to 6 GHz, the RF Receiver Assembly utilizes a zero-IF down conversion architecture, with up to 200 MHz of instantaneous bandwidth (IBW). A dedicated Synthesizer assembly provides the RF Receiver with a local oscillator (LO), necessary for this range. For frequencies below 70 MHz the down-converter is bypassed and signals are input directly to the analog to digital converter (ADC). RF Receiver Assembly firmware provides device control and path switching.

RF Generator Assembly

See [Figure 2-6 on page 2-9](#) for a block diagram of the mA-6806's RF Generator Assembly.

The RF Generator Assembly utilizes a zero-IF up-conversion RF scheme from 400 MHz to 6 GHz with up to 200 MHz of IBW. The RF Generator Assembly also has a dedicated Synthesizer Assembly to provides the necessary LO for this frequency range. For frequencies below 400 MHz, signals are output directly from the digital to analog converter (DAC). The RF Generator Assembly firmware also provides embedded device control, path setup, and RF output automatic level control (ALC).

RF Combiner Assembly

See [Figure 2-4 on page 2-7](#) for a block diagram of the mA-6806's RF Combiner Assembly.

The RF Combiner Assembly serves as an RF interface to route signals from either the RF Input or RF Duplex connectors to RF Receiver Assembly and out either the RF Output or RF Duplex connectors from the RF Generator Assembly. The RF Duplex port facilitates full-duplex operation and can also handle higher power levels, as it has an in-line 20 dB attenuator to protect the RF Receiver and RF Generator.

Instrument Carrier Module (ICM)

See [Figure 2-3 on page 2-6](#) for a block diagram of the mA-6806's ICM.

The ICM and associated firmware provides local processing, data storage and RF hardware interfaces. The ICM controls and communicates with the RF hardware via Serial Peripheral Interface (SPI) buses.

The ICM also provides interfaces to the Backplane GbE, PCIe, trigger, and timing buses, as well as providing power supply conditioning from the Chassis backplane.

Module Firmware

Module firmware programming the VST's various SoC (system-on-chip) and Field Programmable Gate Array (FPGA) devices, which host their respective capabilities, serves a wide variety of purposes including calibration, hosting Application Programming Interface (API) control, providing list mode sequencing, setting trigger conditions, and providing volatile storage for waveform record and playback.

mA-6806 Connectors

This chapter identifies and describes the mA-6806 connectors.

- mA-6806 Connectors 2-2
- Trigger Connectors (1:4) 2-2
- RF Input/Output Connectors 2-3
 - RF Output Connector (5) 2-3
 - RF Duplex Connector (6) 2-3
 - RF Input Connector (7) 2-3

mA-6806 Connectors

Figure 2-1 mA-6806 Connectors

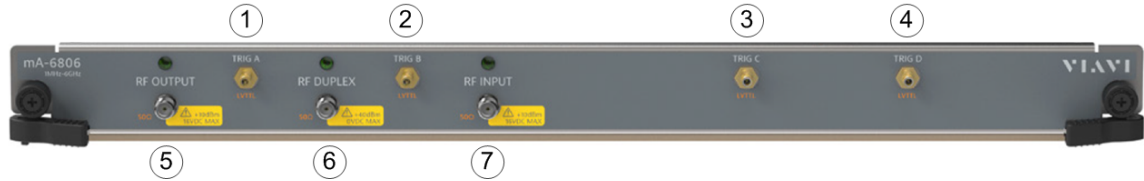

CAUTION

Do not overload input connectors. Refer to product Safety and Compliance Specifications or the product data sheet for maximum input ratings.

Mise en Garde

Identifiez les conditions ou les activités qui, si ignorées, peuvent entraîner des dommages à l'équipement ou aux biens, p. ex. un incendie.

Trigger Connectors (1:4)

The VST contains four independent trigger input/output connectors. Trigger inputs/outputs are selected and configured using the VST UI Client or one of the other tools available for operating the VST module. Refer to [Chapter 4 “mA-6806 Operation and Control”](#) for information.

Refer to [Table A-4 “Maximum Input Level”](#), product data sheet or front panel labeling for maximum input ratings.

RF Input/Output Connectors

RF Output Connector (5)

The RF Output connector is the Transceiver's dedicated RF Output port. The RF Output connector provides the maximum RF output level from the RF Generator.

RF Duplex Connector (6)

The RF Duplex connector has an in-line 20 dB, 10 W attenuator and is used for high power simplex or duplex operation. The Duplex Port is used for RF input and RF output simultaneously. This is typically used for testing using a single direct connection to the unit under test. It can also be used for over-the-air testing when only a single antenna is available.

Refer to [Table A-4 “Maximum Input Level”](#) or the front panel labels for maximum input ratings.

RF Input Connector (7)

The RF Input connector is the VST's dedicated RF Input port. The RF Input Connector should be used when measuring low level RF signals. Refer to [Table A-4 “Maximum Input Level”](#) or the front panel labels for maximum input ratings.

This page intentionally left blank.

Figure 2-2 mA-6806 Block Diagram

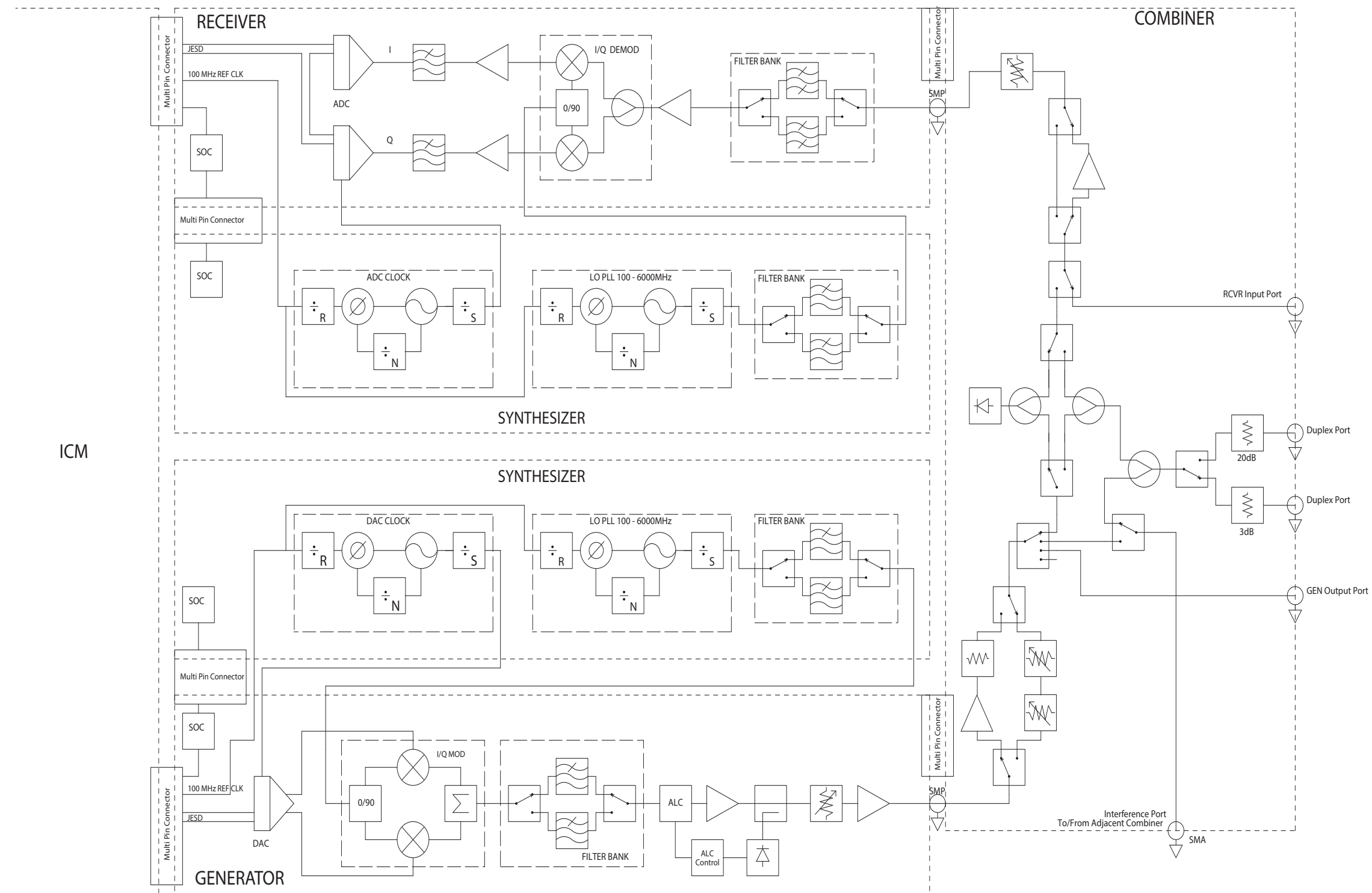

Figure 2-3 mA-6806 ICM Block Diagram

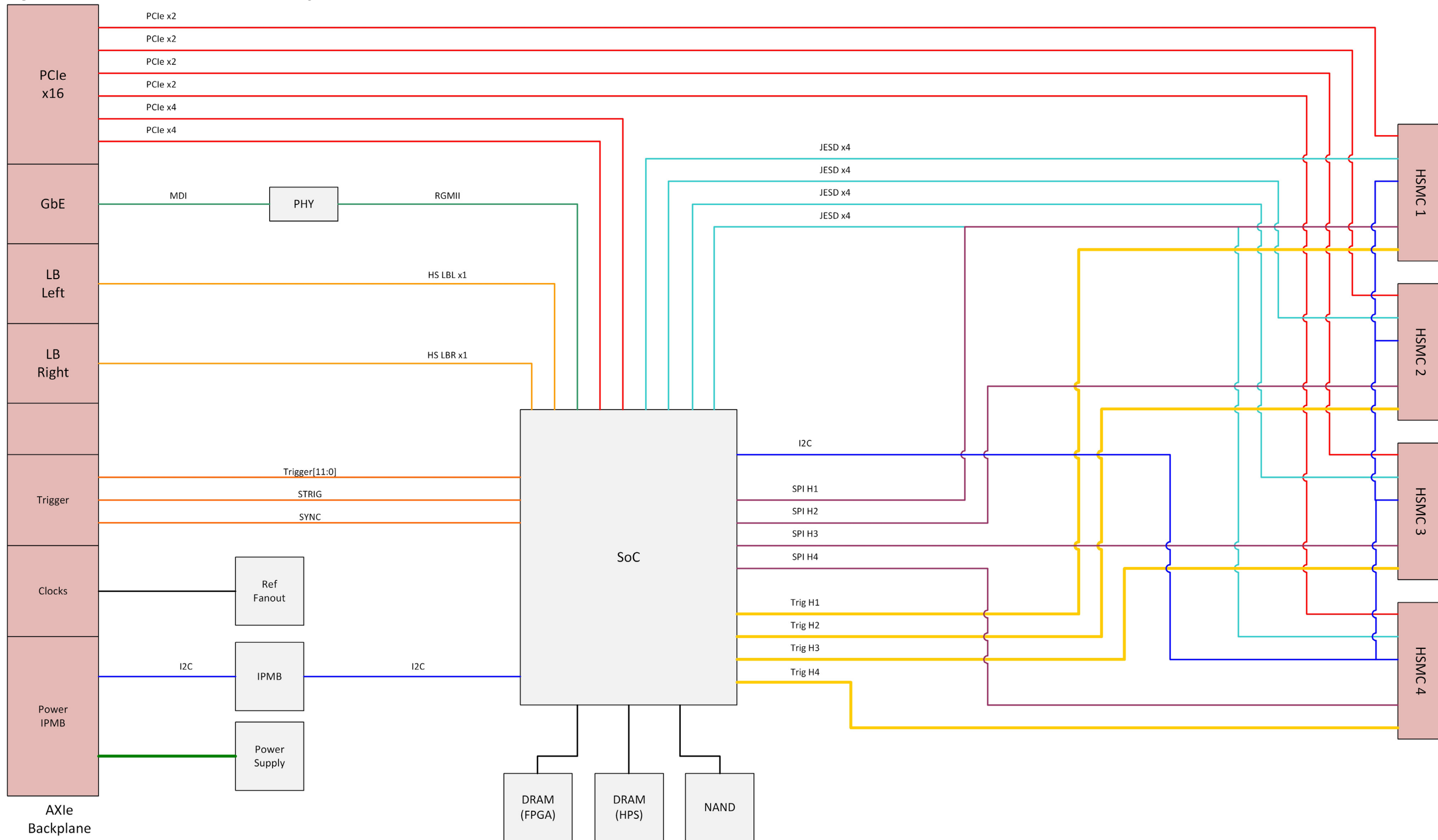

Figure 2-4 mA-6806 RF Combiner Block Diagram

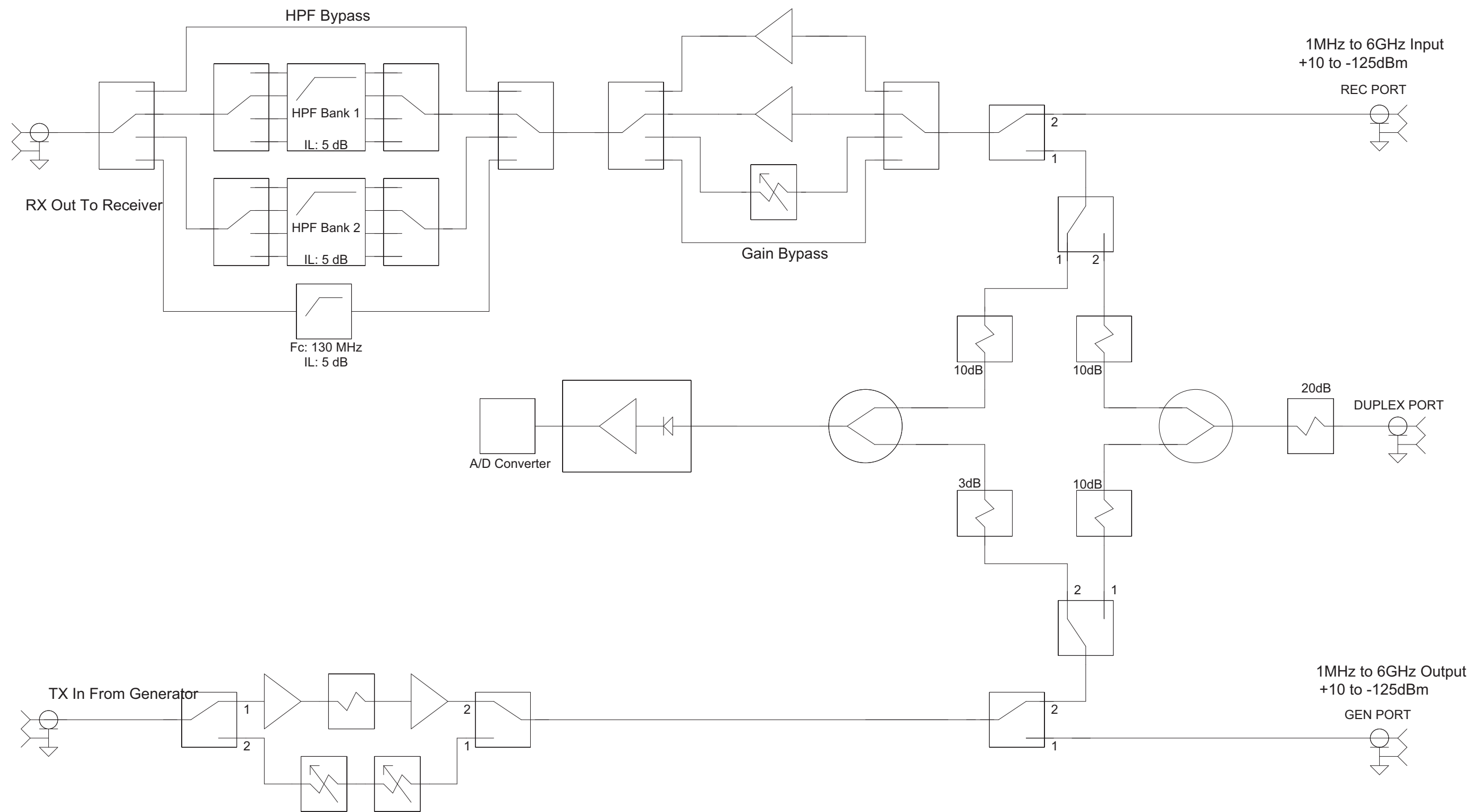

Figure 2-5 mA-6806 RF Receiver Block Diagram

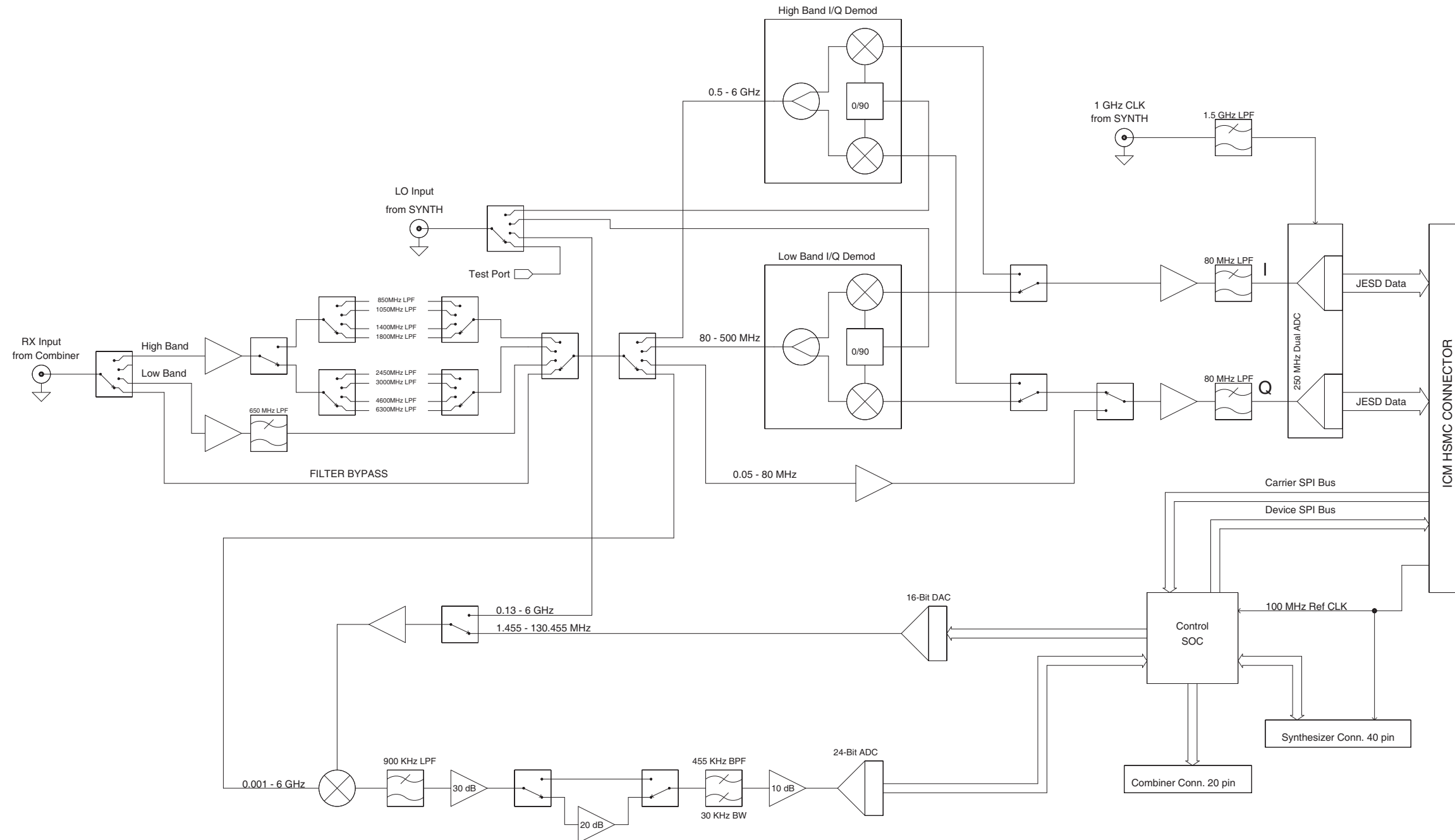
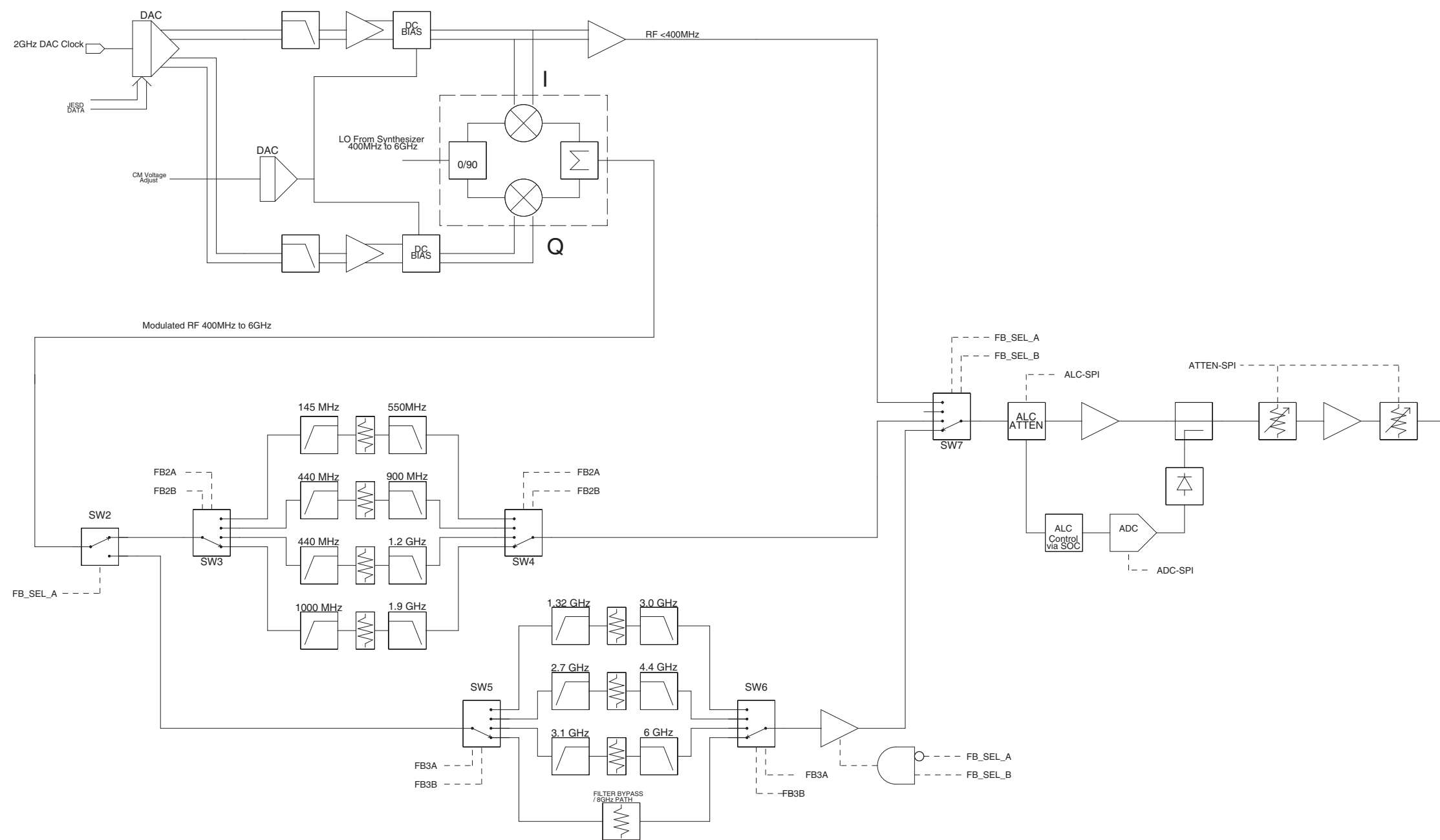

Figure 2-6 mA-6806 RF Generator Block Diagram



This page intentionally left blank.

mA-6806 Setup and Installation

This section contains setup and installation instructions for the mA-6806 module.

- Upon Receipt 3-2
 - Unpack the Device 3-2
 - Verify Contents 3-2
 - Inspect the Device 3-2
 - Module Installation 3-3
- Module Operation Verification Procedure 3-3



NOTE

Refer to mA-1302/mA-1305 AXIe Chassis Operation Manual for Chassis setup and operating instructions.

Upon Receipt

This section identifies tasks that should be performed when the module is received from the factory.

Unpack the Device

Specially designed packing material protects the device during shipping. Avoid damaging the shipping container and packing material when unpacking the device; if necessary the shipping container and packing material can be reused to ship the device.



CAUTION

This device is ESD sensitive and should only be unpacked by qualified personnel.

Mise en Garde

Cet appareil est sensible aux DES et il doit seulement être déballé par un personnel qualifié.

How to Unpack the Module

- 1 Cut and remove sealing tape on top of shipping container.
- 2 Open shipping container. Remove foam insert and module from shipping container.
- 3 Remove module from between foam inserts.
- 4 Remove module from ESD protective packaging.
- 5 Store packing material and shipping container for possible future use.



NOTE

Refer to Packing Procedure for information and instructions for shipping the module.

Verify Contents

Refer to the packing list to verify shipment is complete. Report any discrepancies to VIAVI Customer Service.

Inspect the Device

Inspect the device for possible damage incurred during shipment. Report any damage to VIAVI Customer Service.

Module Installation

The mA-6806 module is designed for installation in AXIe Chassis that meet AXIe-1 Revision 2.0, Base Architecture Specification. See [“Module Removal/Installation Procedures” on page 7-5](#) for module installation instructions.

Module Operation Verification Procedure

The following procedure is intended to verify basic module operation. This procedure does not verify that the module is operating within product specifications.



NOTE

The following procedure is intended to verify basic module operation. This procedure does not verify that the module is operating within product specifications.

How to Verify module Operation

- 1 Complete [“Module Removal/Installation Procedures” on page 7-5](#).
- 2 Complete Chassis Installation Procedure (refer to mA-1302/mA-1305 AXIe Chassis Operation Manual).
- 3 Power on the Chassis (refer to mA-1302/mA-1305 AXIe Chassis Operation Manual).
- 4 [“Open the VST Web UI” on page 5-2](#).
- 5 Open the [“Self Test Page” on page 5-5](#).
- 6 Run the [“VST Self Test Procedure” on page 7-4](#).

This page intentionally left blank.

mA-6806 Operation and Control

This section describes how to operate and control the mA-6806.

- Module Software/Drivers 4-2
- Module Power On/Off Procedures 4-2
 - Power On Procedure 4-2
 - Power Off Procedure 4-3
- Module Control and Operation 4-3
 - mA-6806 Web Browser UI 4-3
 - Chassis Web Browser UI 4-3
 - VST UI Client 4-4
 - External Software Applications 4-4
- VST Network Settings 4-5
 - VST Default IP Address 4-5
 - Locate VST IP Address 4-6
 - mA-6806 Network Mode 4-8
 - Configure VST Network Mode of Operation 4-8
 - Emergency IP recovery 4-10

Module Software/Drivers

The drivers and software required to support streaming from the mA-6806 module to other Chassis modules depends on the type of Host Controller used in the system, the software applications installed in the host controller and the other modules installed in the Chassis.

If the mA-6806 module shipped from the factory as part of a CMP System that contains an mA-3011 AXIe Embedded Host Module, the required drivers and software were installed in the CMP System prior to shipment.

If the mA-6806 module was purchased separately from a CMP System, drivers and software applications (when applicable) need to be downloaded and installed in the Host Controller per system configuration requirements. Contact VIAVI Customer Service for technical support to determine system driver and software requirements.

Module Power On/Off Procedures

The module is powered on during the Chassis power up process. When the Chassis is powered on, power is routed from the AC power supply to the module via the module's connection to the Chassis Backplane. Refer to the mA-1302/mA-1305 AXIe Chassis Operation Manual for the Chassis power up procedure.

Power On Procedure

The module is powered on during the Chassis power up process. When the Chassis is powered on, power is routed from the AC power supply to the module via the module's connection to the Chassis Backplane. To ensure proper module identification and enumeration, do not change external connections or interrupt the Chassis power up process. Refer to the mA-1302/mA-1305 AXIe Chassis Operation Manual for the Chassis power up procedure.

Power Off Procedure

The module is powered down during the Chassis power down procedure. Refer to the mA-1302/mA-1305 AXIe Chassis Operation Manual for proper power down procedure.



CAUTION

Do not power down the module by disconnecting the Chassis from the AC Power Supply. Failure to properly power down the module may result in lost data and/or damage to the module's operating system.

Mise en Garde

Ne mettez pas le module hors tension en débranchant le châssis de l'alimentation électrique CA. Une mise hors tension inadéquate du module peut entraîner des pertes de données ou endommager le système d'exploitation du module.

Module Control and Operation

The means of controlling the mA-6806 module depends on the System's hardware and software configuration. This section identifies the tools available to access and/or control the mA-6806 module.

mA-6806 Web Browser UI

The mA-6806 Web Browser User Interface (Web UI) is a basic interface that displays module information, module operational status and provides user's with the ability to update the module's operating system.

The Web Browser UI's do not support operational or configuration capabilities. Configuration and operational capabilities are supported by external software applications such as the VST UI Client or Signal WorkShop™ Analysis Suite.

See [“Open the VST Web UI” on page 5-2](#) for information about how to access the mA-6806 Web UI.

Chassis Web Browser UI

The Chassis Web Browser UI also provides access to mA-6806 module information and readings. Refer to the mA-1302/mA-1305 AXIe Chassis Operation Manual for instructions regarding Chassis operation.

VST UI Client

The Vector Signal Transceiver User Interface Client (VST UI Client) is packaged and distributed as part of the Transceiver's firmware. The VST UI Client is a basic software interface that is used to configure the Transceiver to generate live signals, playback waveform files and to display and/or record incoming signals.



NOTE

Refer to the section titled “[VST UI Client Distribution](#)” on page 6-2 for information about how to access and operate the VST UI Client.

External Software Applications

VIAVI has developed several software applications such as the Signal WorkShop™ Analysis Suite for use with the mA-6806 Vector Signal Transceiver.

Refer to the CMP product web page on the VIAVI Solutions website at <https://www.viavisolutions.com/en-us/products/modular-axie> for information about the software applications that are available for use with CMP hardware.

VST Network Settings

This section contains instructions to connect to the VST via a network connection. See [“Open the VST Web UI” on page 5-2](#) for information about web browser access, controls and settings.



DEFAULT STATIC IP NOTICE

The module ships from the factory with an assigned Static IP Address. Do not connect the module to your local area network (LAN) without contacting your IT department to determine if the module's default IP Address is already in use. If the module's default IP Address is already in use by a device on the network, connecting the module to the network will cause a network conflict.

It is recommended that the module be reconfigured to use a Static IP address assigned by your IT department before connecting the device to a LAN.

VST Default IP Address

The VST's IP Address is needed to access the module using various user interface tools and software applications. In the event the module's IP Address has been changed, see the section below (“Locate VST IP Address”).

The VST's default IP Address is: 10.105.8.35.



NOTE - DUAL SYSTEMS

When a new CMP system containing two mA-6806 modules is received from the factory, the default IP address of the second mA-6806 is 10.105.8.36

Chassis default Network Settings:

- Network Mode: Static IP
- Static IP Address: 10.105.8.32

Locate VST IP Address

In the event the VST's IP Address has been changed, the VST's IP Address can be identified using the following procedure:



NOTE

This procedure applies to a CMP Chassis that contains an mA-3011 AXIe Embedded Host Module.

If the VST is installed in a VIAVI CMP AXIe Chassis that does not contain an mA-3011 AXIe Embedded Host Module, the VST's IP Address can be located from the Chassis Web UI. Refer to the mA-1302/mA-1305 AXIe Chassis Operation Manual for instructions.

If the VST is installed in a chassis that is not part of the VIAVI CMP AXIe product line, refer to the user documentation that accompanied the chassis for information about identifying module information.

To Identify IP Address:

- 1 Power on the CMP System.
- 2 Open a web browser window.
- 3 Enter "localhost" in the browser's URL field.
- 4 The mA-3011 Embedded Host Module web browser will be displayed.

Figure 4-1 Local Host Web UI homepage

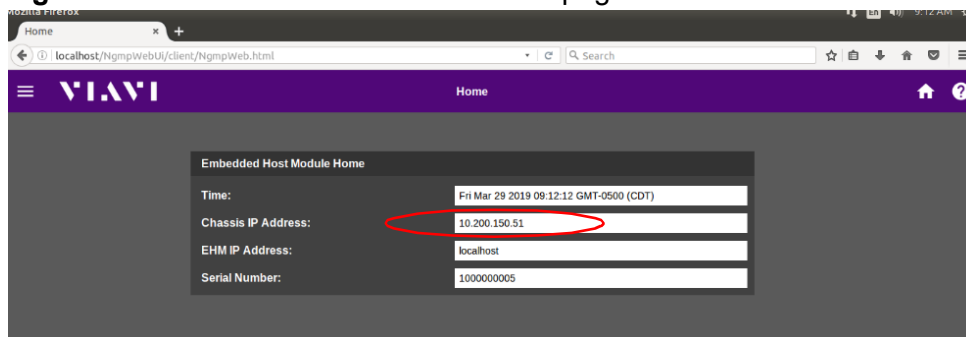

- 5 Record the Chassis IP Address from the mA-3011 Web UI Home page.
- 6 Open another browser window.
- 7 Enter the Chassis IP address in the browser URL field.
- 8 The Chassis Web Browser UI is displayed.
- 9 Select the System Main menu button (upper left corner).
- 10 Select the Chassis Networking button from the System Main menu.

- 11 The Chassis Networking page displays the IP Address for each module in the system.

Figure 4-2 Chassis Web UI Networking Page

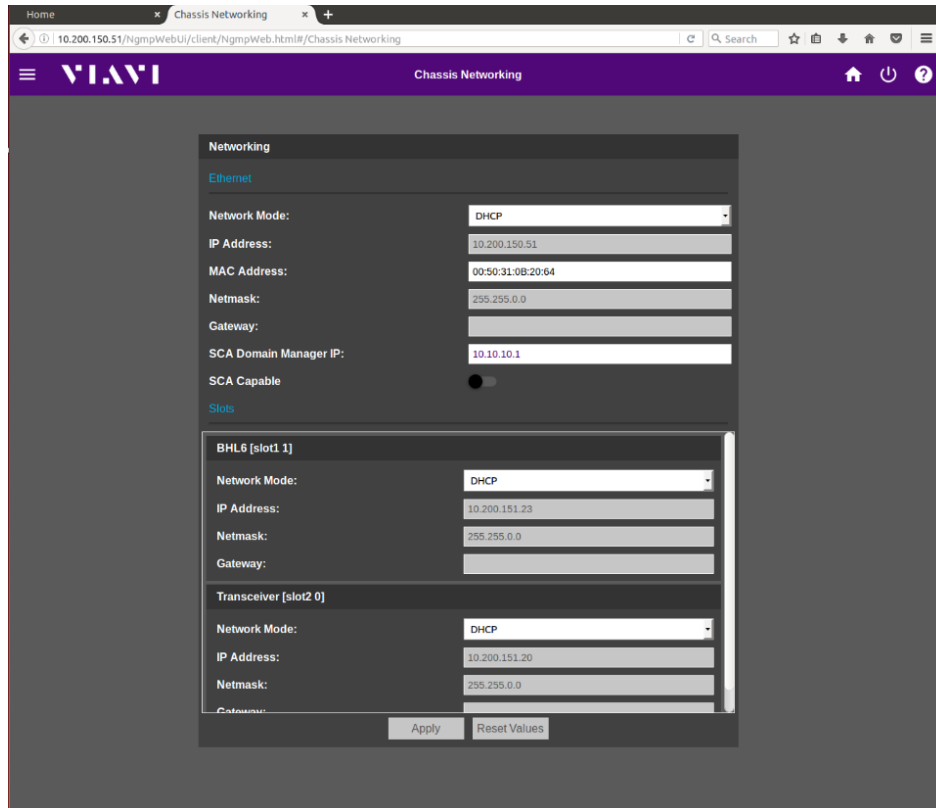

NOTE

- Figure 4-2 shows the PREFERRED location for changing the IP addresses of the individual modules. This page provides the unique ability for the user to view and/or change all module IP addresses from one convenient central location. NOTICE: ALL THE MODULES MUST BE WITHIN RANGE OF ONE ANOTHER, OR THE SYSTEM WILL NOT FUNCTION.
- When changing IP addresses, or changing to/from DHCP, making these changes from this web page allows all the IP addresses to be visualized from one convenient location.
- If the user selects "apply" and then "apply only", he/she will then be able to visualize the changed values and verify that all changed as desired/expected before rebooting the system. In this case, the power button on the front panel can be used to reboot the system. After rebooting, verify the IP addresses changed as expected.
- Multiple reboots may be required.

mA-6806 Network Mode

The procedures in this section describe how to configure the VST network settings using the VST Web UI.



NOTE

When the mA-6806 Network Mode is changed, the current Web Browser UI connection will be lost after the unit is rebooted. A new Web Browser connection will need to be established with the updated mA-6806 IP Address.

Configure VST Network Mode of Operation

The procedures in this section require the VST's IP Address. If you do not know the VST's IP Address, see ["Locate VST IP Address" on page 4-6](#).

If the VST is installed in an mA-1302/mA-1305 AXIe chassis, the preferred method of configuring the VST network settings is to use the Chassis Web UI, as shown in [Figure 4-2](#). This is the proper location for changing the IP addresses (Refer to the mA-1302/mA-1305 AXIe chassis Manual if necessary).



NOTE

The chassis, CPUC, and VST modules must have a netmask and IP addresses, so that all these modules are within visible range of each other. If they are not, system communication will be lost! For this reason, changing to and from DHCP should be done from this page, as well as any static IP address assignments. Failure to do so will result in the need to perform network recovery procedures.

Alternate Method of Setting Module to use Static IP Address

- 1 Power on the CMP System.
- 2 Open a web browser window.
- 3 Enter the VST IP address in the browser window URL field.
- 4 Navigate to the VST Networking page (see ["VST Networking Page" on page 5-4](#)).
- 5 Set the module Network Mode to **Static**.
- 6 Enter desired IP address for the VST.
- 7 Select the Apply button.

- 8 At user prompt, select the Apply and Reboot button.



NOTE

The system will initiate an auto reboot sequence that takes approximately 2 minutes. If the system does not auto reboot, press the Power On/Standby button and refer to the following:

- If the Power On/Standby button turns green, the system has initiated the reboot sequence. Wait while the system completes the power up process.
- If the Power On/Standby button turns yellow, the system failed to initiate the power on sequence. Press the Power On/Standby button again to initiate the power on sequence and wait while the systems completes the power up process.

Set Module to Use DHCP IP Address



NOTE

When DHCP Configuration is initiated, the mA-6806 IP Address updates and the Web Browser UI connection will be lost. Refer to section [“Locate VST IP Address” on page 4-6](#).

- 1 Power on the CMP System.
- 2 Open a web browser window.
- 3 Enter the VST IP address in the browser window URL field.
- 4 Navigate to the VST Networking page (see [“VST Networking Page” on page 5-4](#)).
- 5 Set the module Network Mode to **DHCP**.
- 6 Select the Apply button. At user prompt, select the Apply and Reboot button.



NOTE

The system will initiate an auto reboot sequence that takes approximately 2 minutes. If the system does not auto reboot, press the Power On/Standby button and refer to the following:

- If the Power On/Standby button turns green, the system has initiated the reboot sequence. Wait while the system completes the power up process.
- If the Power On/Standby button turns yellow, the system failed to initiate the power on sequence. Press the Power On/Standby button again to initiate the power on sequence and wait while the systems completes the power up process.

Emergency IP recovery

This procedure is used to recover and reset the VST IP Address when the IP Address is unknown.

- Chassis emergency recovery 169.254.11.11
 - Contact Chassis webpage on 169.254.11.12
- VST emergency recovery 169.254.11.16
 - Contact VST webpage on 169.254.11.17



NOTE

If multiple VSTs are in the chassis, only one VST can be recovered at a time (i.e. any other VSTs must be temporarily slid out far enough to remove from being seated in the chassis backplane). This is because the VSTs will interfere with each other and will all reset to the same address if the others aren't removed.

Emergency IP recovery Procedure

- 1 Set laptop to VST emergency recovery IP 169.254.11.16 (Net 255.0.0.0) and connect Ethernet cable from laptop to Chassis. Reboot Chassis. This will cause the VST to temporarily reset itself to the default IP address 169.254.11.17.



NOTE

This will revert to previous IP if VST is rebooted before the VST IP is reset.

- Using browser on laptop, go to VST default web page (169.254.11.17), which will take you to the temporary VST networking page (similar to [Figure 4-3](#)).

Figure 4-3 Emergency IP recovery 1

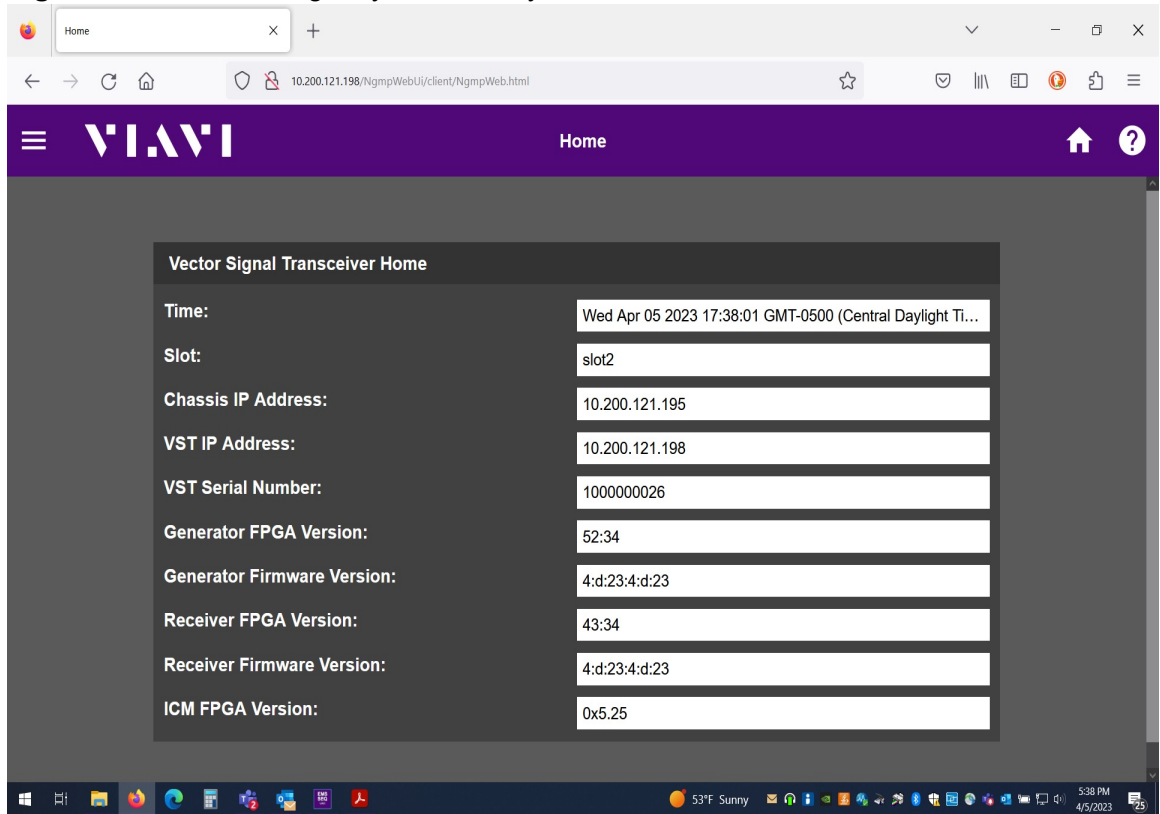

- Then, click on the Main Menu Button, and select the VST networking page shown in [Figure 4-4](#), then reset IP to desired address from the chassis networking page (See [Figure 4-5](#)).

Figure 4-4 Emergency IP recovery 2

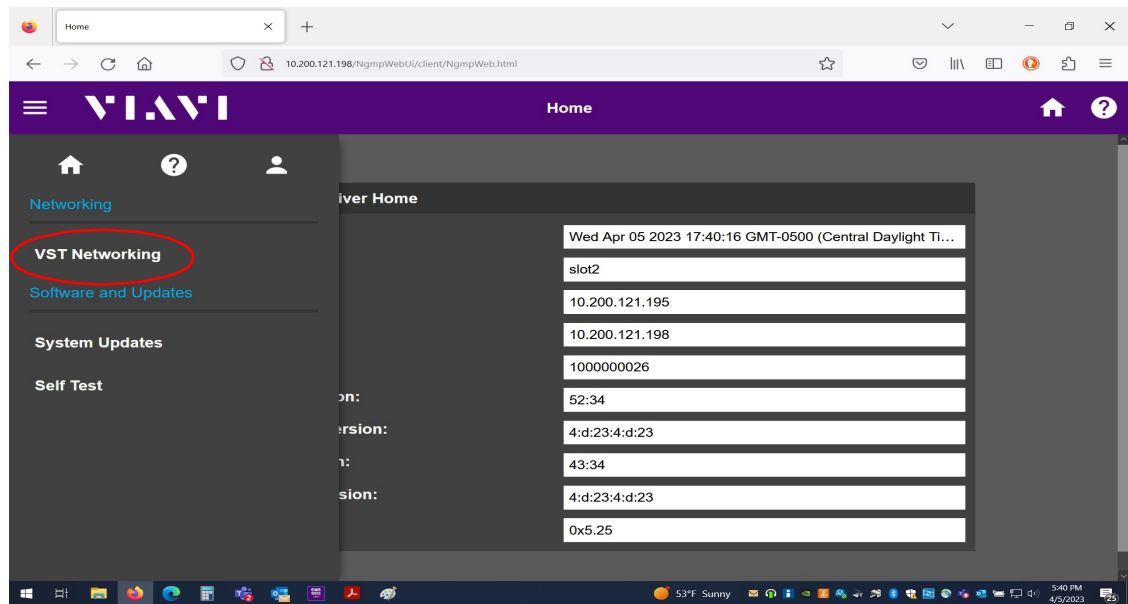
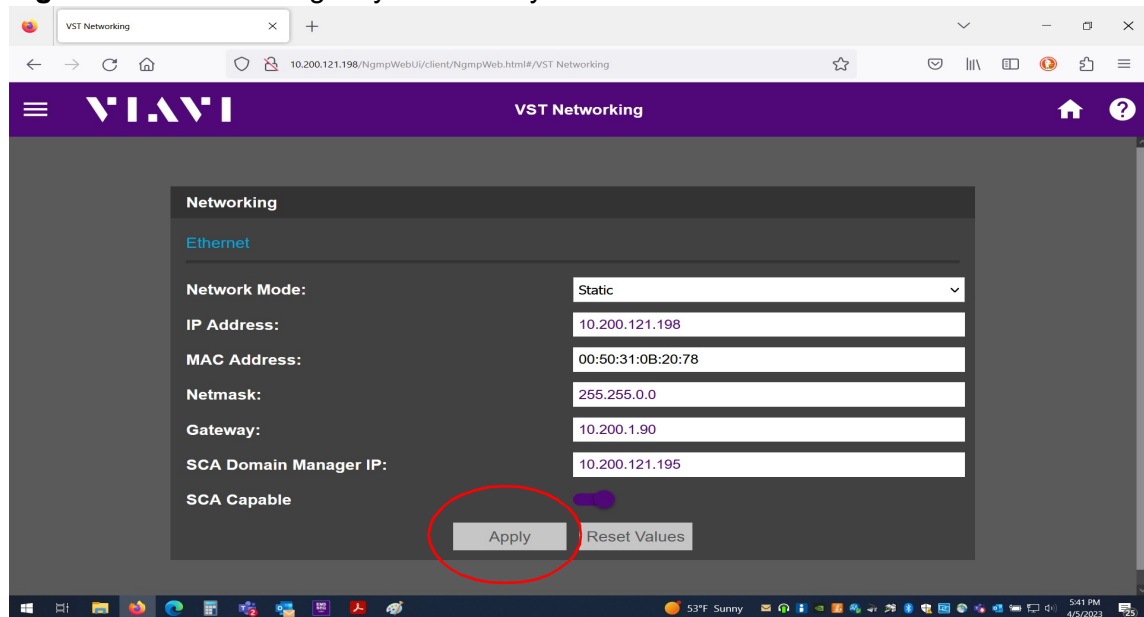

Figure 4-5 Emergency IP recovery 3



- 4 Change laptop IP address and reboot chassis. (The new IP assignment will activate on reboot, as long as the VST does NOT see the emergency recovery IP address.)
- 5 To verify the IP changed, using browser on laptop browse to chassis web page at the new IP assigned in step 2, then go to the chassis instrument slots page and write down IP addresses for the other modules in the chassis.

- 6 Browse to the web pages for the RF module(s) at the IP address(es) discovered in step 4, resetting any as appropriate.



NOTE

all of these IP address assignments must be able to see each other, or you will have to repeat this procedure again. IP's must be in range of each other, netmasks must agree, gateways must match, etc. If using DHCP, addresses assignments should be within range of each other, as it is assumed the DHCP server will not set IP addresses outside their ability to see each other.

- 7 The VST's recovery address is 169.254.11.16 and the module can be contacted at 169.254.11.17.

This page intentionally left blank.

mA-6806 Web Browser UI

This chapter explains the VST's web browser User Interface (UI) tool.

- Introduction 5-2
- Recommended Browsers. 5-2
- Open the VST Web UI 5-2
 - VST Web UI Components. 5-3
- Web UI Pages 5-4
 - VST Networking Page. 5-4
 - Self Test Page. 5-5

Introduction

The Vector Signal Transceiver Web Browser User Interface, referred to as the VST Web UI, is a basic interface that displays module information and operational status. The VST Web UI also provides user's with the ability to update the module's operating system and perform a module self test.



NOTE

The VST Web UI does not support operational or configuration capabilities. Configuration and operational capabilities are supported by external software applications such as the VST UI Client (refer to [“VST UI Client Distribution”](#)).

Recommended Browsers

Recommended browsers for viewing CMP AXIe Web Browser User Interfaces:

- Google Chrome Version 53.0.2785.116 m (64-bit) or later
- Firefox Version 48.0.1 or later
- Internet Explorer 11 or later

Open the VST Web UI

The module's IP Address is required in order to open a VST Web UI session. Refer to the section titled [“VST Default IP Address” on page 4-5](#) for information to access the VST IP Address.

How to Open the VST Web UI

- 1 Open a web browser window (refer to section titled [“Recommended Browsers” on page 5-2.](#))
- 2 Enter the module's IP Address in the browser's URL field.
- 3 The module's Web Browser UI opens and will resemble the example shown in [Figure 5-1 on page 5-3.](#)

VST Web UI Components



Main Menu Button

The Main Menu is used to access module information and configuration pages.



Home Button

Pressing the Home Button returns to the VST Web UI Home Page.



Help Button

Pressing the Help Button displays information for accessing VST User Documentation.

Figure 5-1 VST Web UI Home Page

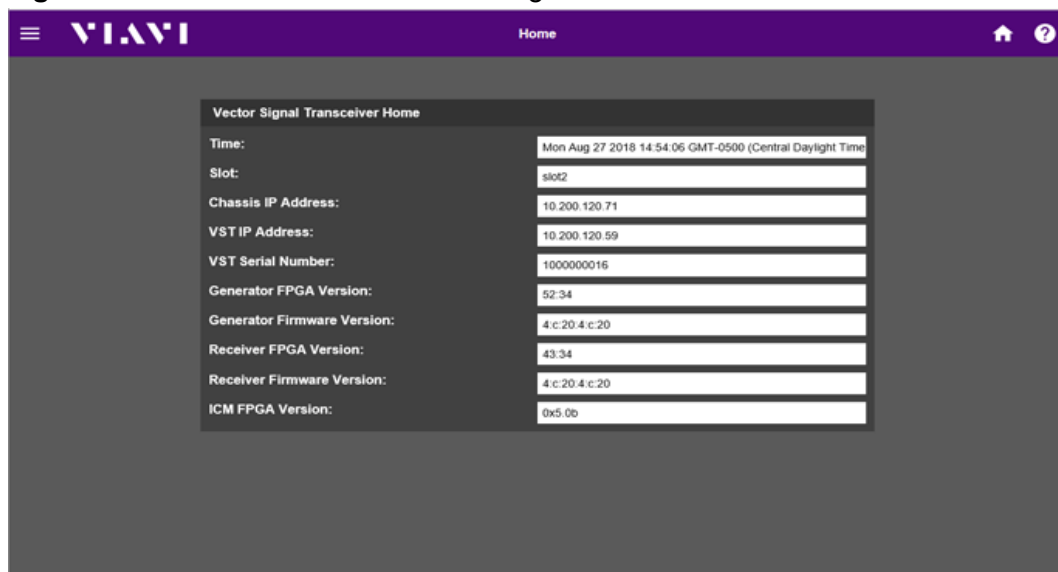

Web UI Pages



This section describes the pages found in the VST Web Browser UI. The Web UI pages are accessed from the Main Menu.

VST Networking Page

The VST Networking Page is used to configure the module's network connection. Refer to [“mA-6806 Network Mode” on page 4-8](#) for information about how to configure the VST for network use.

Figure 5-2 VST Networking Page

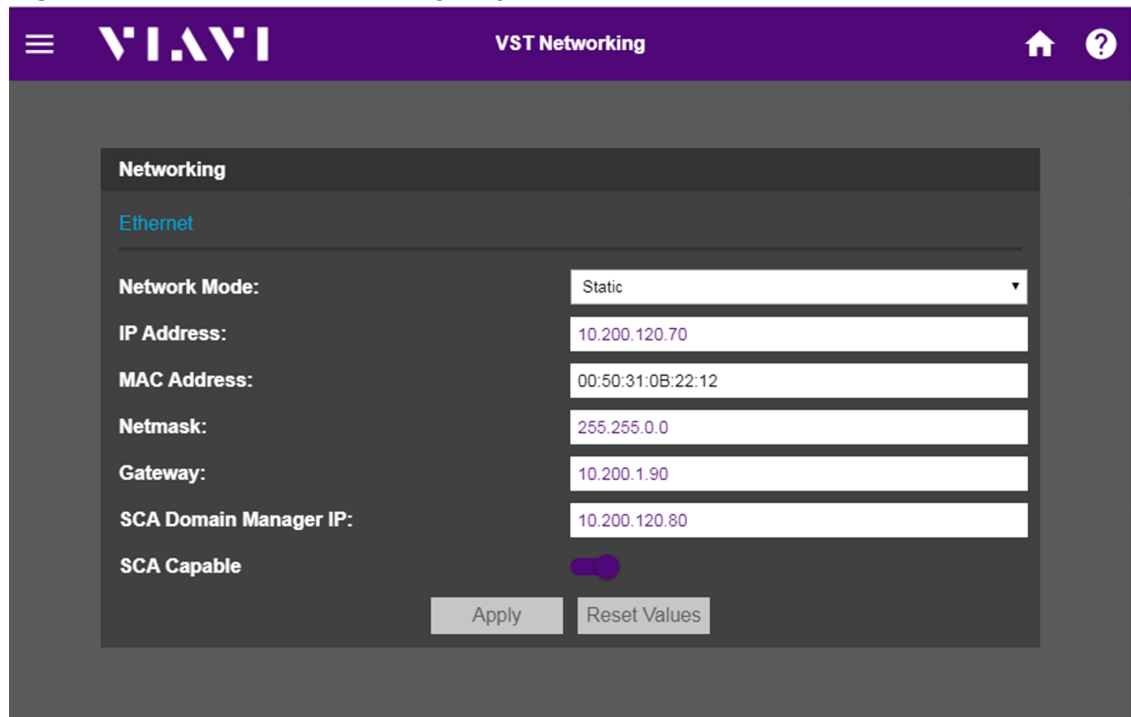

Self Test Page

The Self Test Page accesses the VST's Self Test procedures. The VST Self Test is an automated process that evaluates the module's operational status to verify that module temperature and power readings are within tolerance.

Figure 5-3 VST Self Test Page

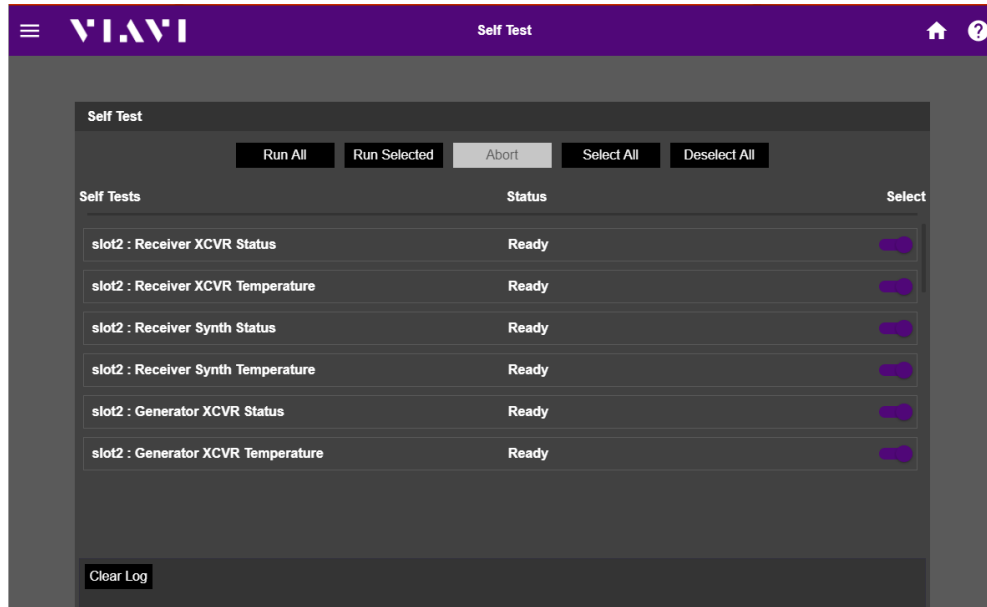

Refer to the [“VST Self Test Procedure” on page 7-4](#), for instructions on running the VST Self Test.

Self Test Controls

The following describes the function of the buttons seen on the self test page.

Run All Button

Pressing the Run All Button enables and runs all Self Test procedures.

Run Selected Button

The Run Selected Button runs the selected Self Test procedures.

Abort Button

The Abort Button is enabled when a Self Test Procedure is initiated. When running multiple Self Tests, pressing the Abort Button will stop the series of Self Test procedures as soon as the test that is in process is completed.

Select All Button

The Select All Button enables all Self Test procedures. Use case: to select all but one or two test procedures by enabling all procedures, then deselecting the one or two test procedures that you do not wish to run, then press the Run Selected Button.

Deselect All Button

The De-select All Button disables all Self Test procedures. Use case: to select only one or two test procedures by disabling all procedures, then selecting the one or two test procedures that you wish to run, then press the Run Selected Button.

VST UI Client

This chapter describes the VST User Interface (UI) Client software application.

•	Managing Software	6-2
•	VST UI Client Distribution	6-2
•	Installing Software	6-2
•	Updating Software	6-2
•	Software Version Information	6-3
•	VST UI Overview	6-4
•	Introduction	6-4
•	Opening the VST UI Client	6-4
•	VST UI Client Layout	6-7
•	Application Title Bar	6-7
•	VST UI Display Area	6-8
•	UI Control and Operation	6-9
•	VST Receiver	6-10
•	Receiver Staging Area	6-10
•	Receiver UI Components	6-11
•	Receiver Functions	6-14
•	VST Generator	6-23
•	Generator Staging Area	6-23
•	Generator UI Components	6-24
•	Generator Functions	6-29
•	Trigger Panel	6-30
•	Normalize Function	6-32
•	Using the VST	6-35
•	Receiver Functions	6-35
•	Generator Functions	6-35
•	Using Markers	6-36

Managing Software

VST UI Client Distribution

VST UI Client software is distributed with each mA-6806 module. When an mA-6806 module is purchased as part of a new CMP System that contains the mA-3011 AXIe Embedded Host Module, the VST UI Client is installed in the mA-3011 AXIe Embedded Host Module prior to shipment and a backup CD is shipped with the module.



NOTE

When a mA-6806 module is purchased separately from a CMP System, or if the system does not contain the mA-3011 AXIe Embedded Host Module, the VST UI Client is distributed with the mA-6806 module on a CD. The VST UI Client must be installed in the Host Controller per system configuration requirements. Refer to the section below for download and installation information and instructions.

Installing Software

The VST UI Client software is an installation executable that guides users through downloading and installing the software.

Updating Software

Software may be updated periodically to include feature enhancements, additional functionality, or to address any identified software issues. Users should perform routine checks to verify they are using the most recent software version available for the device. See link to [“Firmware and Software Upgrade Procedure” on page 8-1](#) for details and instructions.

Software Version Information

VST UI Client version information is displayed in the About Window. The About Window is accessed from the Receiver Functions Menu.

Figure 6-1 VST UI Client About Window

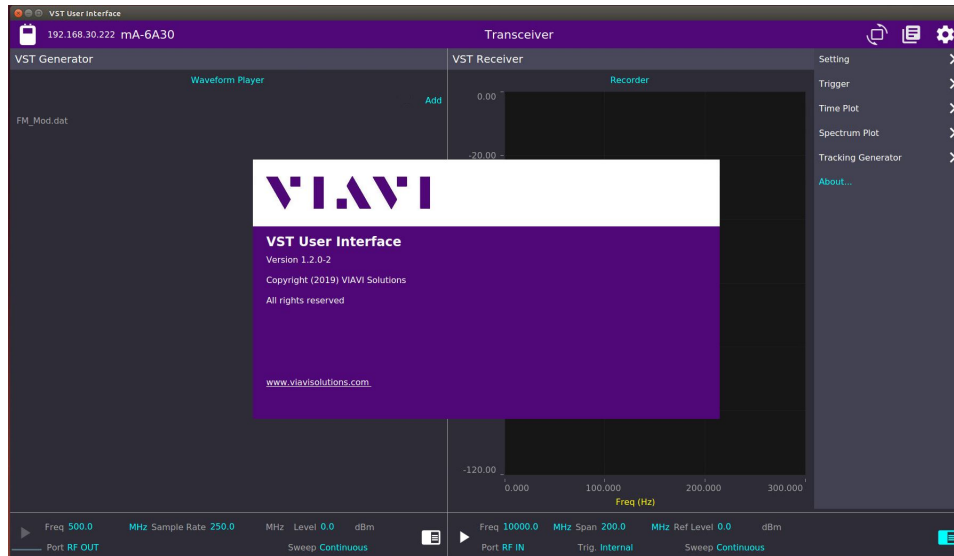

VST UI Overview

Introduction

The Vector Signal Transceiver User Interface Client, referred to as the VST UI Client, is a free software interface with the functional ability to configure and operate the mA-6806. The VST UI Client operates in Simulation Mode to simulate a hardware connection, or Hardware Mode which requires a connection between the mA-6806 and Host Controller.

Simulation Mode provides the user with the ability to familiarize themselves with the VST UI Client without the need for a hardware connection, or when connected to a device, without interfering with device operation.

Opening the VST UI Client

The VST UI Client is opened using techniques native to the Host Controller on which the software has been installed (i.e., Start Menu or Desktop Icon). When the VST UI Client is launched for the first time, the application loads the User Interface (UI) default settings for the selected mode of operation. When the VST UI Client is opened on subsequent occasions, the UI is loaded in the last known state for the selected mode of operation. Verify correct IP address of mA-6806 before attempting to connect.



Mode Button

The Mode Button located in the top left corner of the UI is used to change the VST UI Client mode of operation.

Demo Mode

To open the VST UI Client in Demo Mode:

- 1 Open VST UI Client.
- 2 At prompt, select Demo Button.
- 3 Wait while the VST UI Client is opened.

Figure 6-2 VST UI Client Launch Window

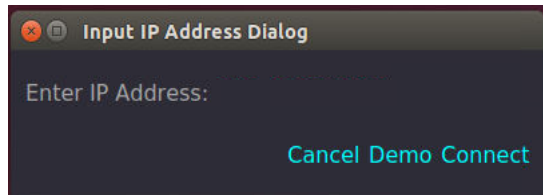

The image below shows an example of the VST UI Client as it appears when the application is opened for the first time in Demo Mode.

Figure 6-3 Demo Mode - Initial View

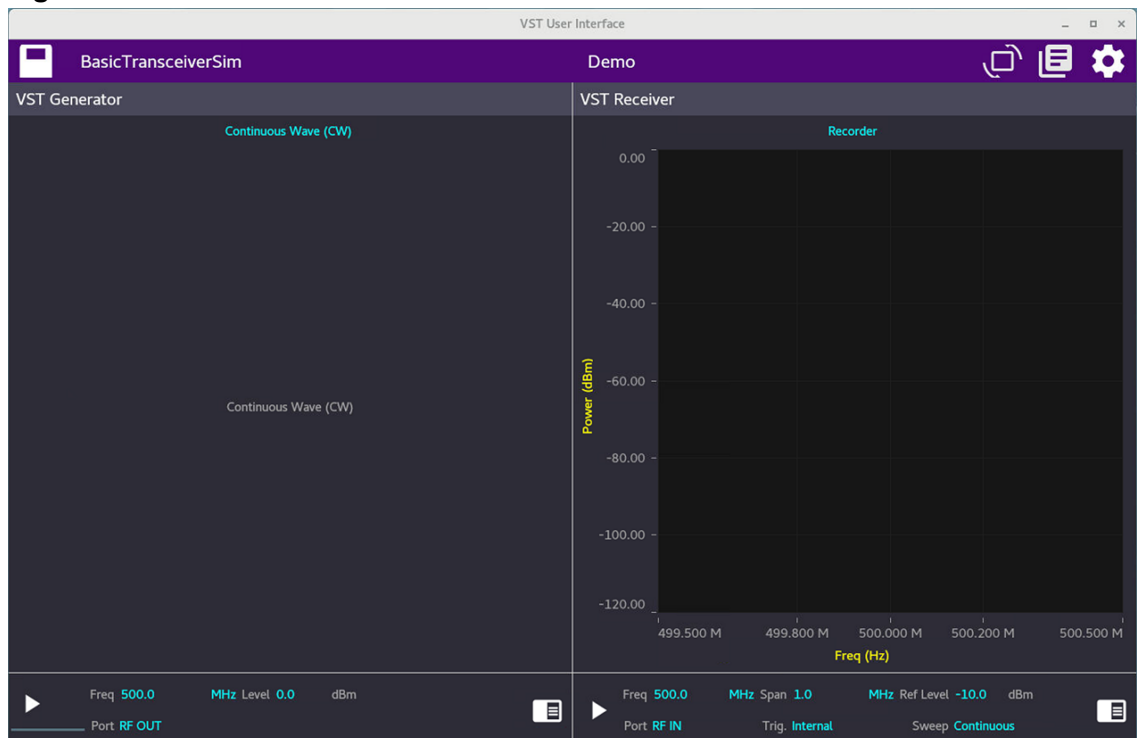

Hardware Mode

To connect the VST UI Client to a mA-6806

- 1 Open VST UI Client.
- 2 At prompt, enter the mA-6806 IP Address (refer to “VST Default IP Address” on [page 4-5](#)) and press the Connect Button.

Figure 6-4 VST UI Client Connection Dialog Window

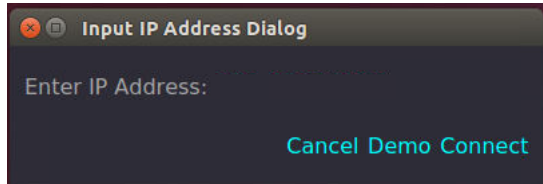

- 3 Wait while the VST UI Client establishes a connection with the mA-6806. When the connection is established with the Transceiver, the Application Title Bar updates to display the IP Address of the VST and the device name as shown in [Figure 6-5 on page 6-7](#).

VST UI Client Layout

The VST UI Client consists of the Application Title Bar and the Main Display Area. The Main Display Area is divided into a Generator Panel and a Receiver Panel.

Application Title Bar

The appearance of the Application Title Bar depends on the selected mode of operation.

When the VST UI Client is connected to a Transceiver (Hardware Mode), the Application Title Bar displays the Mode Button, the IP Address of the VST and the device name.

Figure 6-5 Hardware Mode - Title Bar

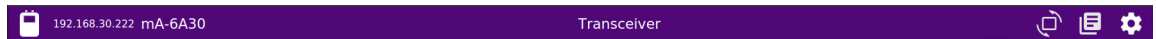

When Simulation Mode is selected, the Application Title Bar displays the Mode Button and the selected mode of operation.

Figure 6-6 Simulation Mode - Title Bar

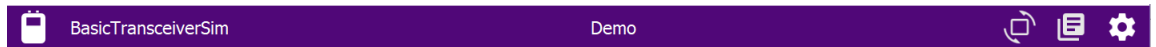

Toggle Button

This button toggles between multiple mA-6806 modules if more than one is installed in the Chassis.



List Button

This button lists all mA-6806 modules currently installed in the chassis.



Utility Menu

This button is used to access the Normalize Function and the File browser.

VST UI Display Area

The Display Area of the VST UI is divided into two sections. The left side of the UI contains Generator settings and functions; the right side of the UI contains Receiver settings and functions. The width of these areas can be adjusted by selecting and dragging the vertical line that divides the two sections of the UI.

The Generator and Receiver sections of the UI contain a Title Bar, a Staging Area and a Function Toolbar. Refer to the image below for reference. Refer to the following sections for information about the controls, settings and functions associated with the VST Generator and Receiver:

- [VST Receiver](#) 6-10
- [VST Generator](#) 6-23

Figure 6-7 VST Generator/Receiver UI Layout

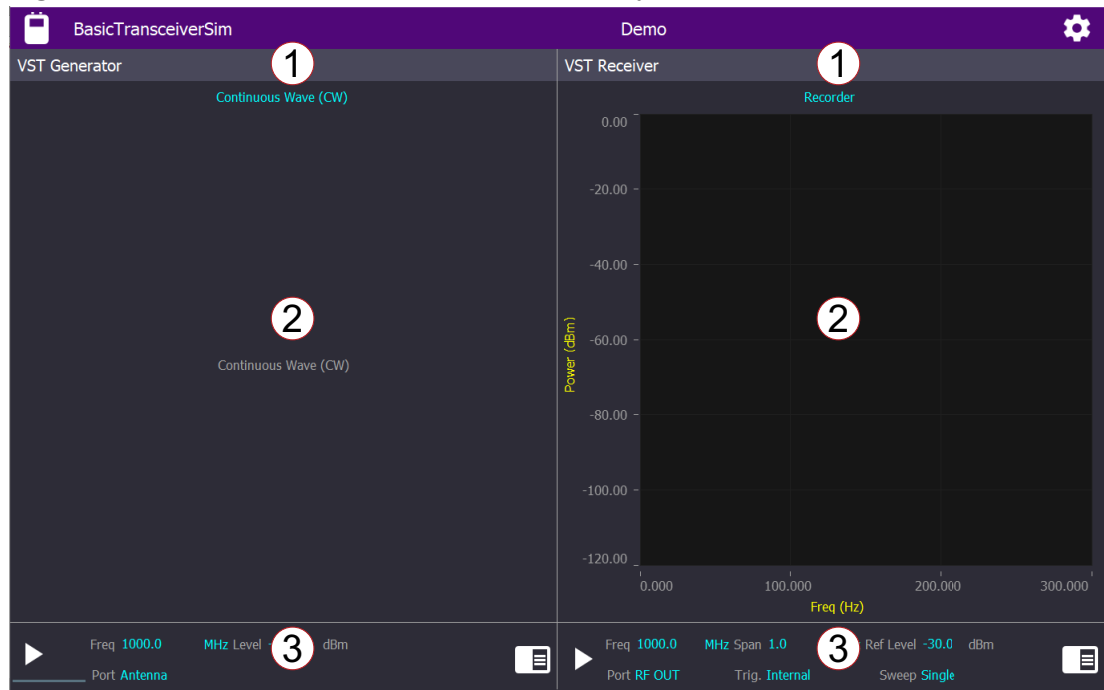

Function Title Bar (1)

The Function Title Bar identifies the Transceiver Function (Generator or Receiver).

Function Staging Area (2)

The Function Staging Area is a dynamic area that changes depending on the selected Generator or Receiver mode of operation as well as the Generator and Receiver functions being performed.

Function Toolbar (3)

The Function Toolbar contains settings and controls that are used to configure and operate the VST Generator and Receiver.

UI Control and Operation

The VST UI Client has been developed to maintain a consistent look and feel when viewed on different Host Controllers and different operating systems. For the most part, the UI looks the same when viewed on a tablet, laptop computer or desktop computer; however there may be slight differences depending on the operating specifications and user settings of the Host Controller.

The behavior of the VST UI Client operates in a manner similar to software applications found in many of today's electronic devices. The VST UI Client is navigated using techniques native to the Host Controller on which the software is installed. For example, touch-screen devices are navigated using techniques like press to select, swiping, pinching to zoom in, pushing to zoom out; desktop devices are controlled using a mouse or keyboard.

The VST UI Client consists of screen components such as menus, text fields, file browser windows, navigation buttons and scroll bars. Host controllers that support hover functionality allow the users to hover over UI Components which will display a component label and in some cases a small description.

VST Receiver

This section describes the UI components, screen layout and functions of the VST Receiver.

Receiver Staging Area

The Receiver Staging Area is a dynamic area that changes according to the selected Receiver mode of operation as well as functions that are enabled on the Receiver.

Figure 6-8 shows an example of how the Receiver Staging Area may be configured when using the Receiver.

Figure 6-8 Example: Receiver Recorder Screen

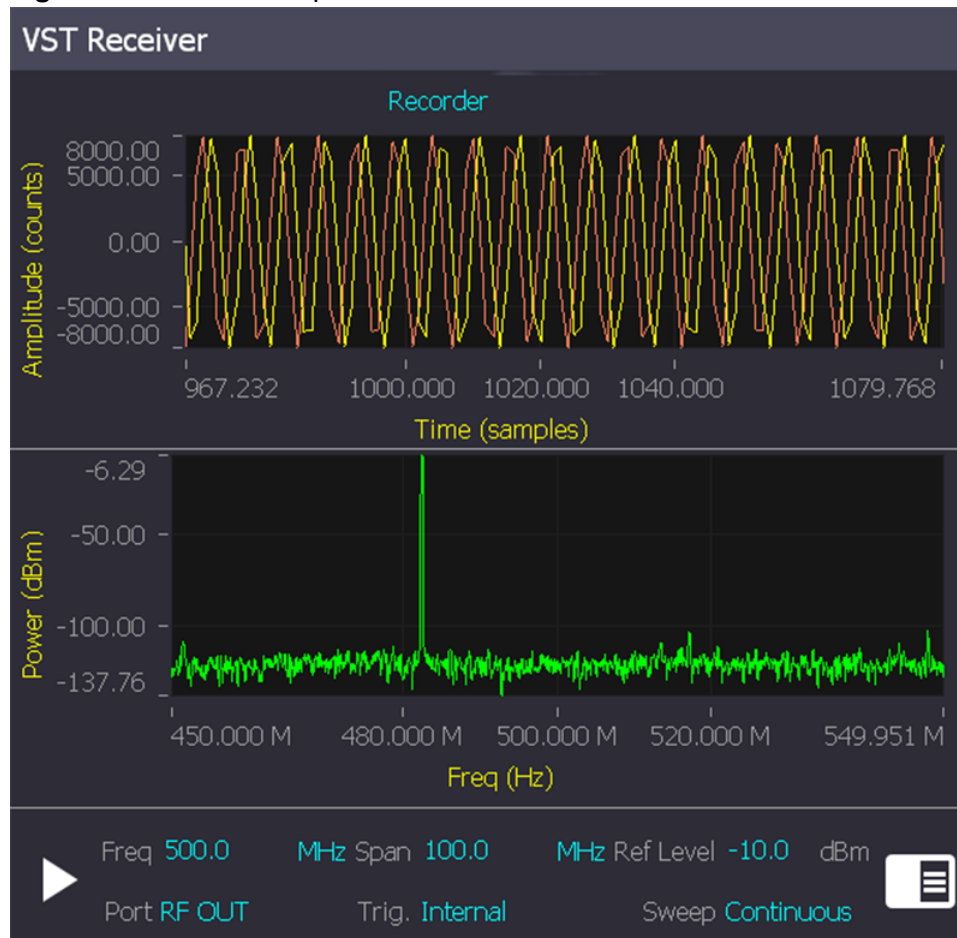

Receiver UI Components

This section describes the controls and settings that are used to configure the VST Receiver.

Recorder Controls and Settings

Recorder controls and settings are used to configure and control the received signal.

Figure 6-9 Recorder Function Toolbar

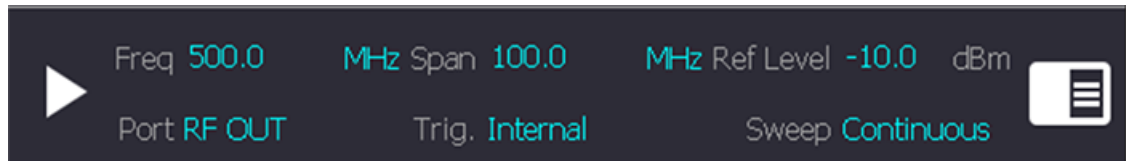

Signal Control Button

The Signal Control Button starts and stops acquisition of a live signal.



Press to start signal acquisition.



Press to stop signal acquisition.

Frequency (Freq) Field

The Freq field defines the center frequency for the signal acquisition being performed. Refer to the mA-6806 Data Sheet for supported frequency ranges and other performance specifications.

Reference Level (Ref Level) Field

The Ref Level defines the expected power level of the signal being received by the VST. The Ref Level is used to adjust the gain of the RF Receiver. Refer to [“Electrical Specifications” on page A-3](#) or front panel labeling for maximum input ratings.

Port Menu

The Port menu is used to select the connector at which the mA-6806 is receiving a signal. The Receive Port should be selected based on the type of signal being received.



CAUTION

Do not overload input connectors. Refer to product Safety and Compliance Specifications or the product data sheet for maximum input ratings.

RF In

The RF Input Connector is used to measure low-power RF signals. Refer to product data sheet for input frequency range.

DUPLEX

The RF Duplex Connector is used to measure high-power RF signals. This connector is capable of simultaneously generating and receiving RF signals. Refer to product data sheet for valid frequency range.

Trigger Source Menu

This menu selects the signal source that the mA-6806 uses for trigger events. Trigger settings are configured on the Trigger Panel (see [“Trigger Panel” on page 6-30](#)).

Internal

When Internal is selected the mA-6806 uses a signal that is routed from the Chassis as a trigger source.

External

When External is selected the mA-6806 uses an external trigger source that is connected to one of the mA-6806 Trigger Input Connectors. Trigger Input connectors are selected on the Trigger Panel (see [“Trigger Panel” on page 6-30](#)).

Sweep Menu

This menu selects the mode used to display the signal trace on the Plot Field.

Single

A single signal sweep is performed. Acquisition stops after the initial sweep is completed.

Continuous

Continuous sweeps are performed until the Signal Control Button is used to stop the acquisition.



Receiver Functions Button/Menu

The Functions Menu Button opens and closes the Receiver Functions Menu. The Receiver Functions Menu accesses additional settings, controls and functions that are used to configure and operate the VST Receiver.

Refer to the section titled “Receiver Functions” on page 6-14 for additional information.

Figure 6-10 Receiver Functions Menu

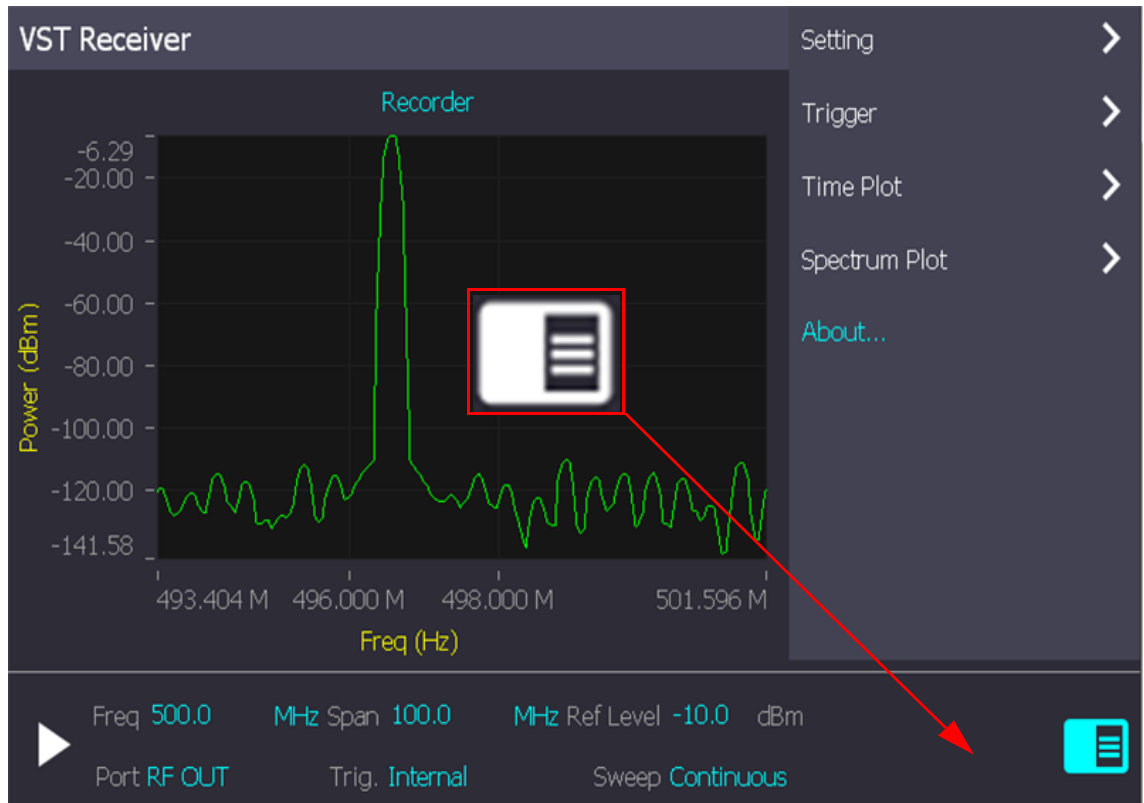

Receiver Functions

Settings Panel

The Receiver Settings Panel is accessed from the Receiver Functions Menu (see [Figure 6-10 on page 6-13](#)). The Settings Panel contains parameters that are used to configure how the VST Receiver processes a signal. These parameters should be set according to the specifications of the receive signal (either live or recorded).

Figure 6-11 Receiver Setting Panel

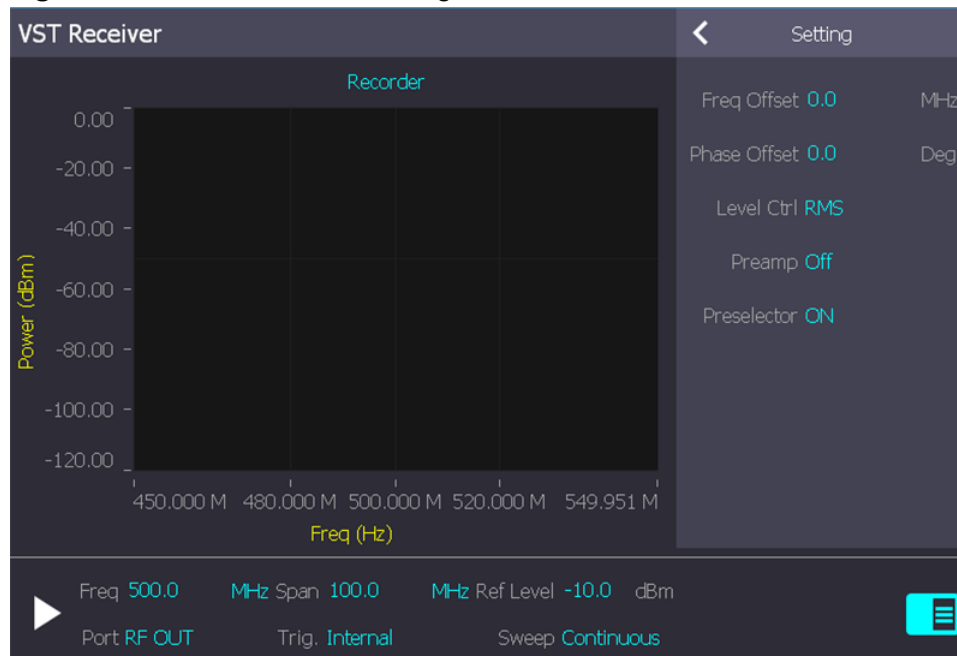

Frequency Offset Field

Defines the value by which the receiver tuning frequency is shifted in reference to the Frequency Field setting. The acquired data will be digitally corrected to display the correct frequency. A frequency offset can be applied to observe signal content that may be obscured by the carrier null located at the center of the captured spectrum.



NOTE

The application of a frequency offset will limit the available instantaneous bandwidth.

Phase Offset Field

Defines the value by which the phase of the measured signal will be shifted (in degrees).

Level CTRL Menu

The Level CTRL menu selects the measurement method the Receiver uses to account for any power fluctuations which may be present in the incoming signal.

AUTO

Automatically detects the level.

Preamplifier Control

This menu enables (ON) or disables (OFF) the Receiver's built-in pre-amplifier. Enabling the pre-amplifier lowers the noise floor level which increases the Receiver's sensitivity.

Pre-selector Menu

This menu enables or disables the Receiver's pre-selector. When the pre-selector is enabled (ON), the Receiver's band-pass filter blocks unwanted frequencies from the receive signal.

Trigger Panel

The Trigger Panel contains parameters that are used to configure how the VST Receiver processes trigger signals used to start a signal acquisition.



NOTE

The trigger signal source is selected from the Trigger Menu which is located on the Receiver Controls and Settings Bar.

Figure 6-12 Receiver Trigger Controls and Settings

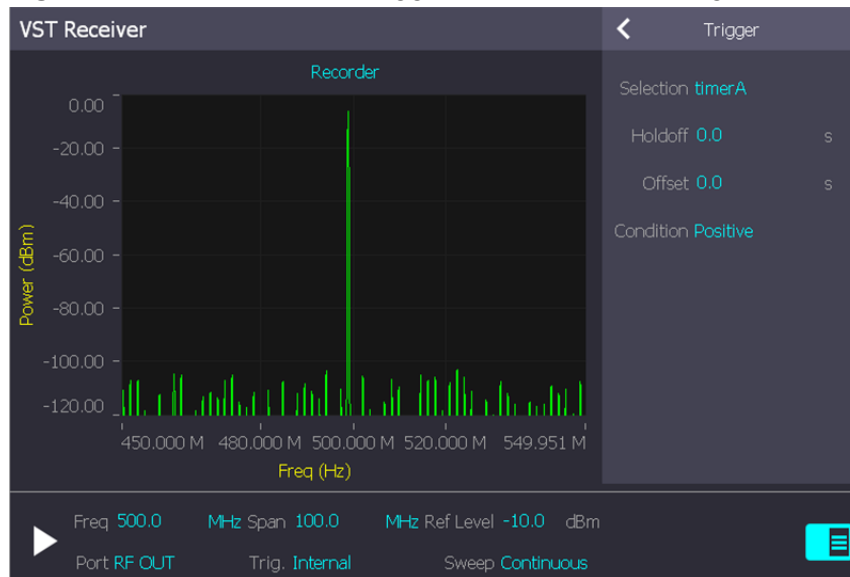

Selection Menu

This menu selects which mA-6806 Trigger Input Connector is being used as a trigger source.

Holdoff Field

Specifies the time between the trigger event and the start of a signal acquisition

Offset Field

This field works in the same manner as the Holdoff field, with the exception that the user can enter a negative value to define pre-trigger data acquisition.

Edge Menus

The Edge Menu selects trigger mode used to trigger an event.

Negative Edge

Negative (falling) edge of the trigger signal is used to trigger an event.

Positive Edge

Positive (rising) edge of the trigger signal is used to trigger an event.

Immediate

Receiver acquisition is started immediately; not tied to a trigger event.

Time Plot Panel

The Time Plot displays a representation of the variation of the amplitude of the signal over time; where Amplitude (count) is a number that is proportional to the input voltage and Time (samples) indicates an index number of a single measurement within an array of measured data. The VST Receiver Time Plot is enabled and configured on the Time Plot Panel.

Figure 6-13 Receiver Time Plot Panel



Visible Tick Box

This tick box enables or disables the plot field on the display.

Y AutoScale Tick Box

This tick box enables or disables the auto-scaling for the vertical scale (Y-axis) of the plot field. When AutoScale is enabled, the plot field's vertical scale is adjusted to values that display the entire vertical range of the waveform.

Marker Controls

Refer to the section titled [“Plot Markers” on page 6-19](#) for information about marker functions.

Spectrum Plot Panel

The Spectrum Plot displays the spectrum of the received signal. The VST Receiver Spectrum Plot is enabled and configured on the Spectrum Plot Panel. By default, the Spectrum Plot is visible on the Receiver Panel unless it is disabled.

Figure 6-14 Receiver Spectrum Plot Panel



Visible Tick Box

This tick box enables or disables the plot field on the display.

Y AutoScale Tick Box

This tick box enables or disables the auto-scaling for the vertical scale (Y-axis) of the plot field. When AutoScale is enabled, the plot field's vertical scale is adjusted to values that display the entire vertical range of the waveform.

Marker Controls

Refer to the section titled “Plot Markers” on page 6-19 for information about marker functions.

Plot Markers

The Time Plot and Spectrum Plot support basic marker functions. Time Plot Markers are added and configured on the Time Plot Panel; Spectrum Plot Markers are added and configured on the Spectrum Plot Panel. When a marker is added to the Plot Field the area below the Plot Field updates to display that Marker Measurement Bar and other marker controls and functions are enabled. The image below shows an example of Time Plot Markers.

Figure 6-15 Time Plot with Markers Enabled



Marker Measurement Bar

The Marker Measurement Bar contains the following components and information:

Marker Tick Box

The Marker Tick Box selects a marker when more than one marker has been added to the plot. Verify the desired marker is selected before pressing any of the Marker Control Buttons.

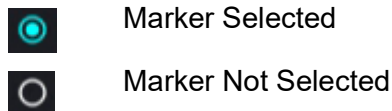

Marker Color Bar

The Marker Color Bar is used to change the color of the selected marker. When a marker is deleted from the Plot Field any changed color settings are not stored.

Time Plot Marker Readings

The Time Plot marker readings display the sample point at which the amplitude measurement was acquired, followed by the amplitude measurement at the indicated sample point.

Figure 6-16 Marker Measurement Bar (Time Plot)

<input type="radio"/>	1	—	2300.0	-12.0	Δ: 253.0 , -44.0	×
<input checked="" type="radio"/>	2	—	2635.0	0.0	Δ: 1076.0 , 24.0	×

Spectrum Plot Marker Readings

The Spectrum Plot marker readings display the frequency at which the power measurement was acquired, followed by the power measurement at the indicated frequency.

Figure 6-17 Marker Measurement Bar (Spectrum Plot)

<input checked="" type="radio"/>	1	—	402.587259 MHz	-95.06 dB	Δ: 2.587259 MHz, 0.34 dB	×
<input type="radio"/>	2	—	401.269221 MHz	-95.90 dB	Δ: 1.269221 MHz, -0.51 dB	×



Delta Indicator

The Marker Delta Indicator is displayed when a Marker Delta has been created. Marker Deltas are removed by deleting the marker. Refer to the section titled [“Using Markers” on page 6-36](#) for information about how to create and delete Marker Deltas.

Delta Measurements

The Delta readings display the differences between the Marker position and the Marker Delta Reference Point. Refer to the section titled [“Using Markers” on page 6-36](#) for information about how to create and delete Marker Deltas.

Marker Controls

Add Marker Button

The Add Marker Button is used to add markers to the plot field. When the maximum number of supported markers have been added to the Plot Field the Add Marker Button is disabled.

Marker Positioning

When a marker is added to the Plot Field, the marker is placed at the center frequency. Markers are moved using the Marker Navigation Buttons or by dragging and dropping the marker to another location on the trace. Refer to the section titled [“Using Markers” on page 6-36](#) for information about how to move markers.

(Marker) Delta Button

The Delta Button is enabled when a marker has been added to the Plot Field. The Delta Button is used to create delta marker measurements.

Refer to the section titled [“Using Markers” on page 6-36](#) for information about how to create and delete Marker Deltas.

Marker Navigation Buttons

The Marker Navigation Arrow Buttons are enabled when a marker has been added to the Plot Field.



Left Arrow Button moves the selected marker to the next data point to the left of the marker's current position.



Right Arrow Button moves the selected marker to the next data point to the right of the marker's current position.



Marker Delete Button

The Marker Delete button is displayed when a marker is added to the Plot Field. Pressing this button deletes the marker from the plot.

About Window

The About Window displays information about VST UI Client software. The About Window is opened by selecting the About Button from the Receiver Functions Menu. The About Window is closed by pressing the About Button or by clicking/selecting the About Window.

Figure 6-18 VST UI Client About Window

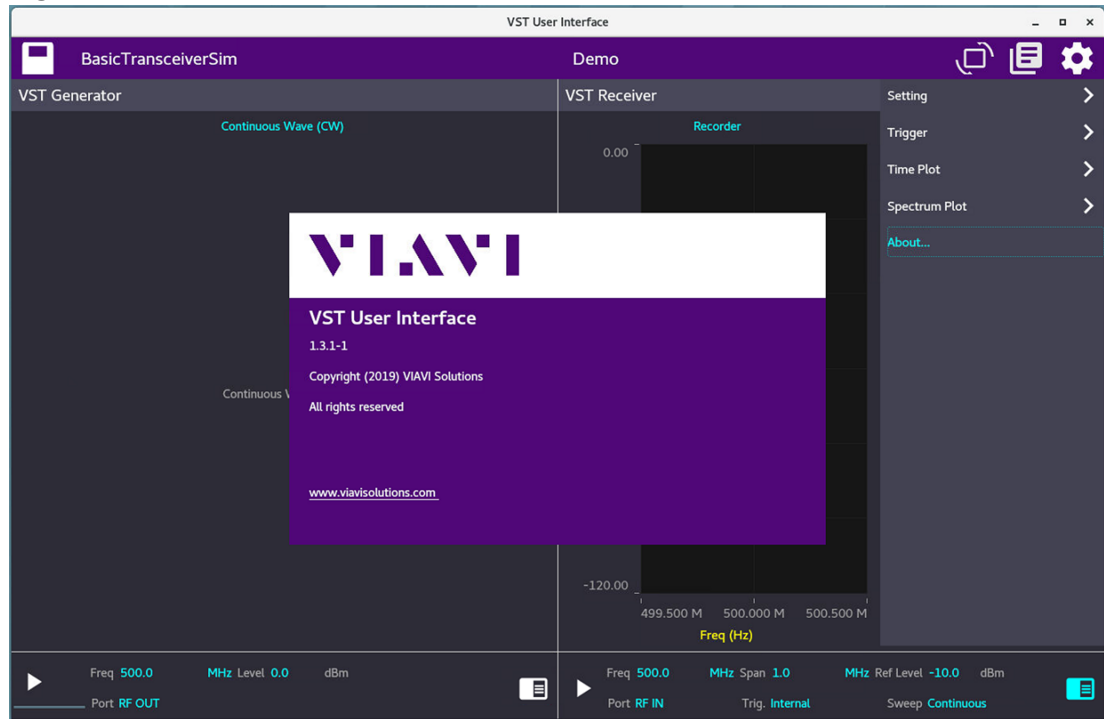

VST Generator

This section describes Generator controls, settings and operation.

Generator Staging Area

The Generator Staging Area is a dynamic area that changes according to the selected mode of operation as well as functions that are enabled on the Generator. The following images show examples of layouts users may encounter when configuring the Generator.

[Figure 6-19](#) shows an example of the Generator Staging Area when Continuous Wave (CW) Mode is selected.

Figure 6-19 Example: Generator Continuous Wave (CW) Mode

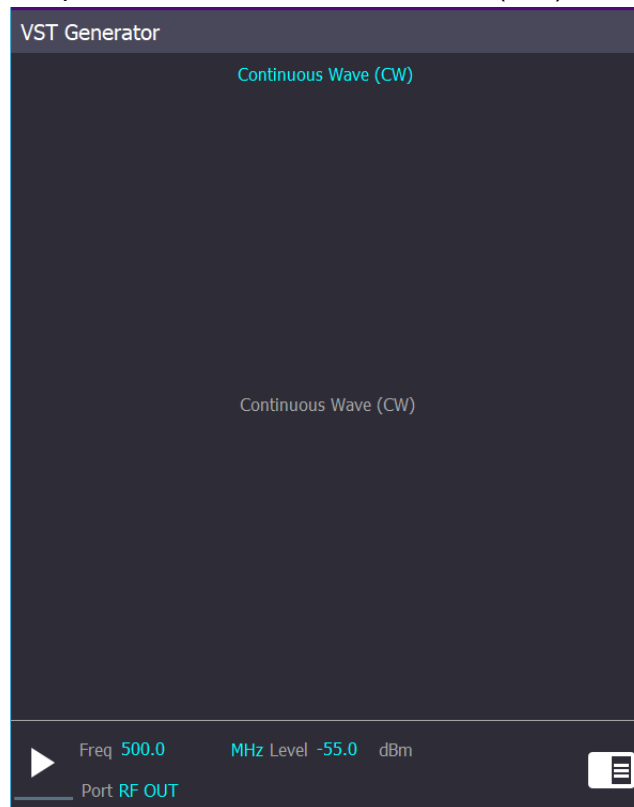

The second image shows an example of the Generator when Waveform Mode is selected.

Figure 6-20 Example: Generator Waveform Player Mode

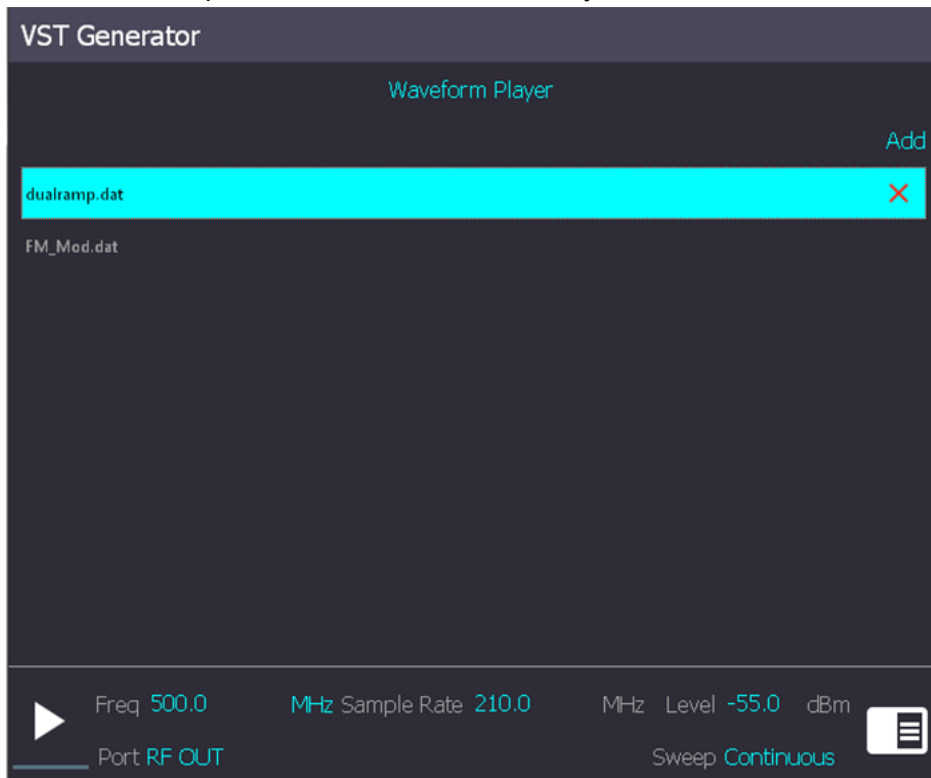

Generator UI Components

This section describe the controls and settings which are used to configure the VST's generator functions.

Mode Menu

The Mode Menu located at the top of the Generator Panel selects the Generator's mode of operation. When a mode is selected, the Staging Area updates to display controls and settings for the selected mode.

Continuous Wave (CW) Mode

CW Mode is used to output a simple, single-frequency CW tone signal.

Waveform Player Mode

Waveform Player Mode is used to output a signal from a waveform file.

Continuous Wave Controls and Settings

Figure 6-21 Continuous Wave (CW) Function Toolbar

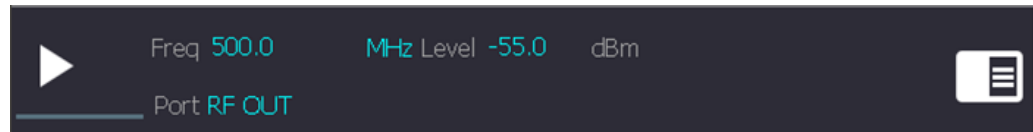

Signal Control Button

The Signal Control Button starts and stops the playback of a Continuous Wave signal (CW Mode) or waveform file (Waveform Player Mode).



Press to play the CW signal (CW Mode) or waveform file (Waveform Player Mode).



Press to stop playing the CW signal (CW Mode) or waveform file (Waveform Player Mode).

Frequency (Freq) Field

The Freq field defines the frequency of the outgoing CW signal.

Level Field

This Level field defines the power level of the outgoing CW signal.

Port Menu

The Port Menu selects the Generator RF Output Connector where the signal is being output. The Generator Output Port should be selected based on the type of signal being generated.

RF Out

The RF Output Connector provides the maximum RF output level from the RF Generator.

DUPLEX

The RF Duplex Connector is used to measure high-power RF signals. This connector is capable of simultaneously generating and receiving RF signals. Refer to product data sheet for valid frequency range.



Generator Functions Button/Menu

The Functions Menu Button opens and closes the Generator Functions Menu. The Generator Functions Menu accesses additional settings, controls and functions that are used to configure and operate the mA-6806 Generator. Refer to the “[Generator Functions](#)” on page 6-29, for details.

Figure 6-22 Generator Functions Menu

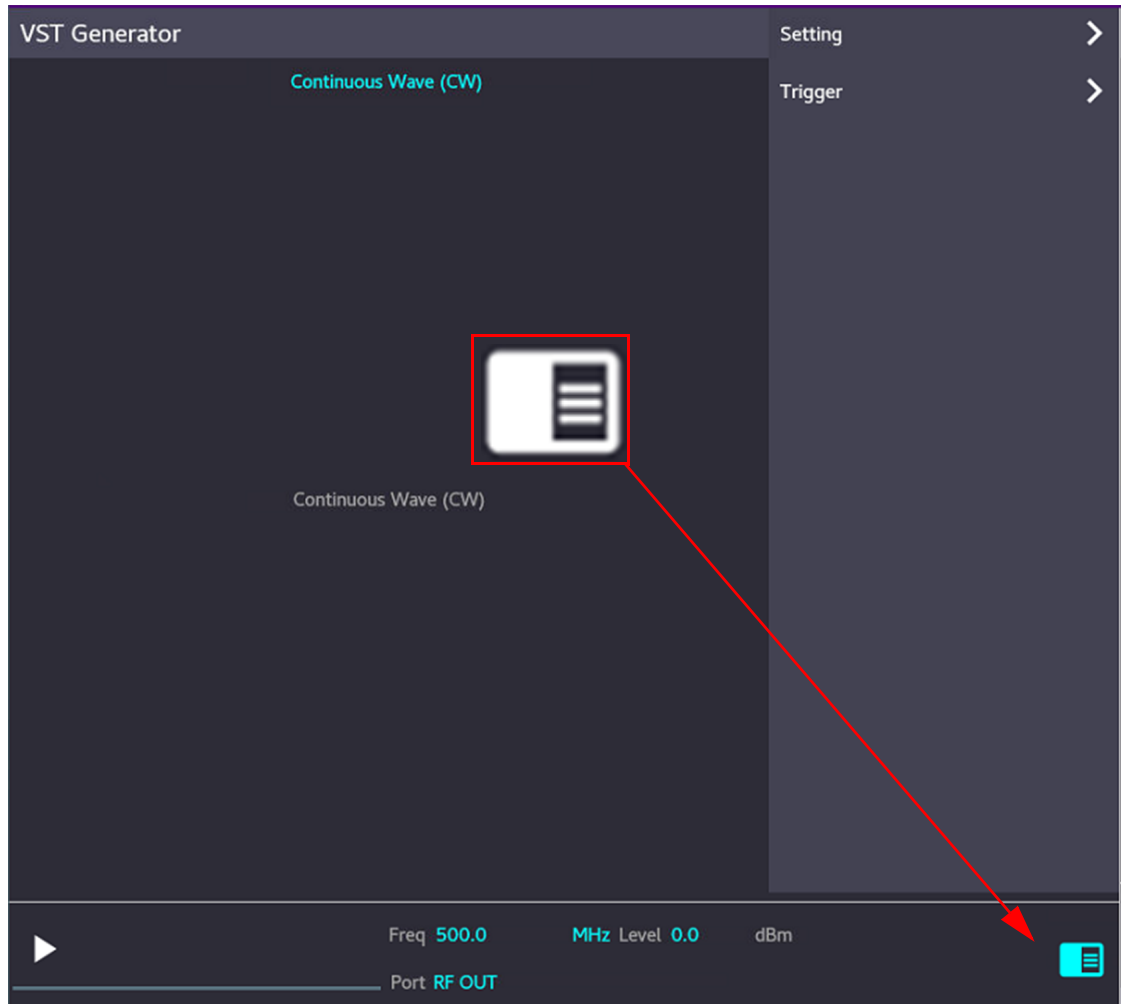

Waveform Player Controls and Settings

Figure 6-23 Waveform Player Controls and Settings

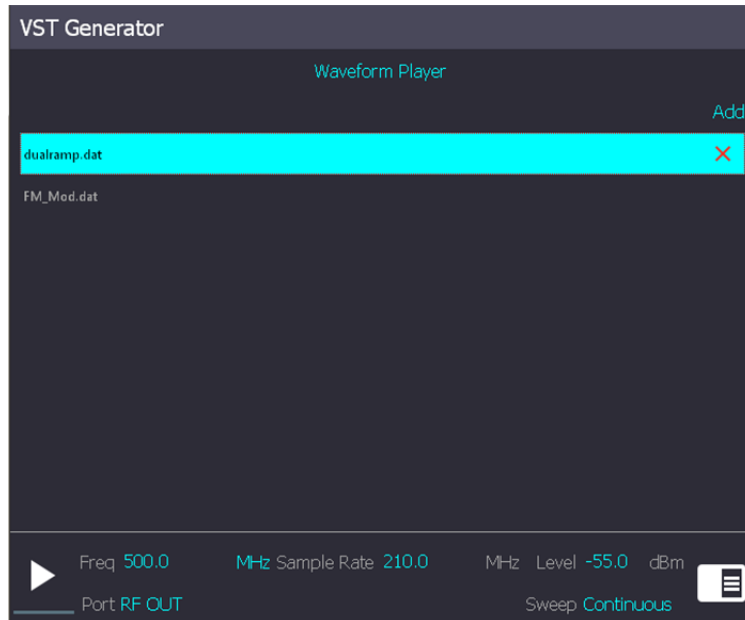

Add Button

Pressing the Add Button opens a window that allows the user to select waveform files that can be added to the Waveform Player File List.

A file is removed from the file list by clicking on the "X" button.

File List Table

This table displays the waveform files that have been added to the Waveform Player File List. A file must be added to the File List before it can be played using the VST Generator Waveform Player.

Sample Rate

The Sample Rate Field defines the Sample Rate at which the waveform will be played. Sample Rate defines number of data points generated per second: value is displayed as a frequency value. For example, 210 samples/second means that 210 discrete data points are generated every second which is displayed as a 210 MHz sample frequency

Time Domain Consideration

To produce an accurate representation of the correct peak amplitude of the signal in the time domain, the Sample Rate should be set to at least 10 times faster than the highest frequency of interest. For example, for a 5 MHz sine wave, the minimum recommended sampling rate would be 50 MHz.

Frequency Domain Considerations

To produce an accurate representation of the correct peak amplitude of the signal in the frequency domain, the Sample Rate should be set to at a minimum of two times faster than the highest frequency of interest. For example, for a 10 MHz sine wave, the minimum recommended sampling rate would be 20 MHz.

Frequency (Freq) Field

The Freq field defines the frequency at which a waveform is played.

Level Field

The Level field defines the power level at which a waveform is played.

Sweep Mode Menu

This menu selects the mode used to output the signal.

Single

The generator will play the waveform only one time.

Continuous

The generator will play the waveform to completion and repeat in a continuous loop until the stop button is activated (see [“Signal Control Button” on page 6-25](#))

Generator Functions

Setting Panel

The Settings Panel contains parameters that are used to configure the waveform that is generated (Continuous Wave (CW) Mode) or played back (Waveform Player Mode) by the mA-6806 Generator.

Figure 6-24 Generator Function Settings Panel

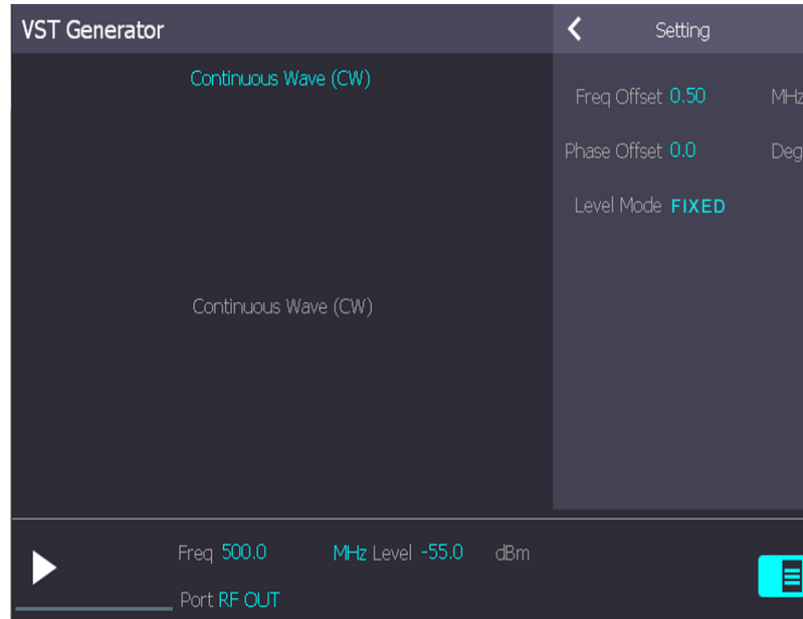

Freq Offset Field

The Frequency (Freq) Offset field defines the value by which the Generator tuning frequency is shifted in reference to the Generator Frequency field. The output signal will be digitally corrected to output at the correct frequency. Offsets can be applied to avoid the carrier null at the center of the Generator bandwidth.



NOTE

Applying a frequency offset will reduce maximum Generator instantaneous bandwidth.

Phase Offset Field

The Phase Offset field specifies the phase shift (in degrees) applied to the Generator output signal.

Level Mode Menu

The Level Mode menu selects the RF level type for the generated signal.

Fixed

The level is a constant value configured by the user in the Level field.

Trigger Panel

Trigger Panel settings and parameters are used to configure how the Generator responds following a trigger event.

Figure 6-25 Generator Function Trigger Panel

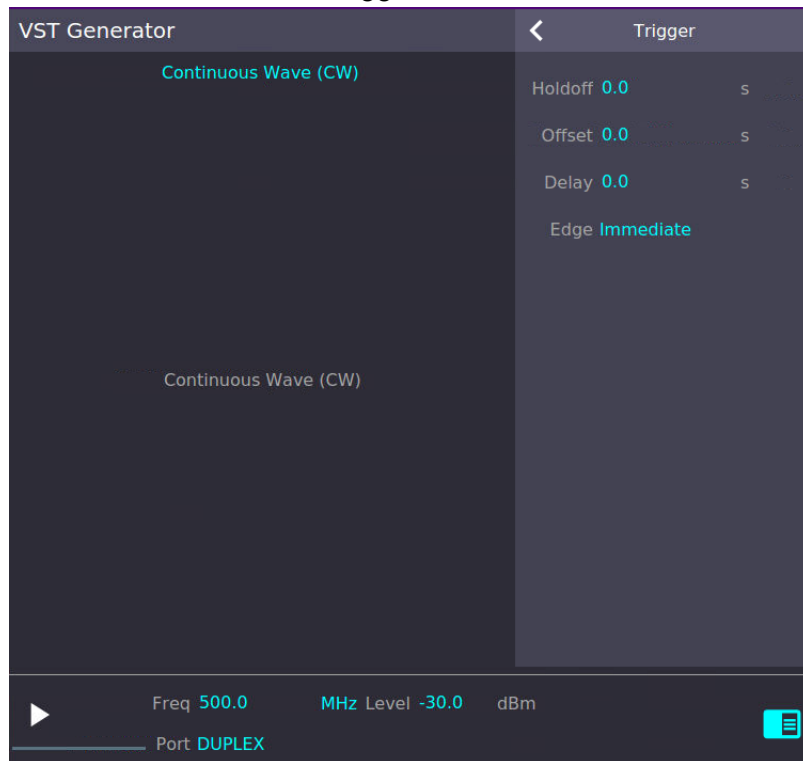

Holdoff Field

This field defines the length of time between when a trigger event occurs and when the Generator initiates signal output. When a trigger event occurs, the Generator pauses the defined length of time before outputting a signal (CW or waveform file).

Offset / Delay Fields

The Offset and Delay fields works in the same manner as the Hold-off setting and create a post trigger delay.

Edge Menu

Defines which edge of the trigger signal is used to initiate signal output.

Negative Edge

The negative (falling) edge of the trigger initiates the Generator's signal output.

Positive Edge

The positive (rising) edge of the trigger initiates the Generator's signal output.

Immediate

Generator output is started immediately when the trigger event occurs.

Normalize Function

The Normalize function performs a series of internal measurements and corrections to reduce measurement inaccuracies which may occur due to environmental conditions. Normalize optimizes various performance parameters, including carrier leakage, IQ gain and balance, Third Order Intercept (IP3), and level correction. Normalize should be performed as often as desired by the user to correct for temperature and time drift (typically at the start of the day, after the equipment has been powered on long enough to reach thermal stability).

Accessing Normalize



The Normalize controls and settings are accessed using the Utility Button. When Normalize is selected, the bottom of the VST UI updates to display a panel that contains the Normalize controls and settings.

Figure 6-26 Accessing Normalize Controls and Settings

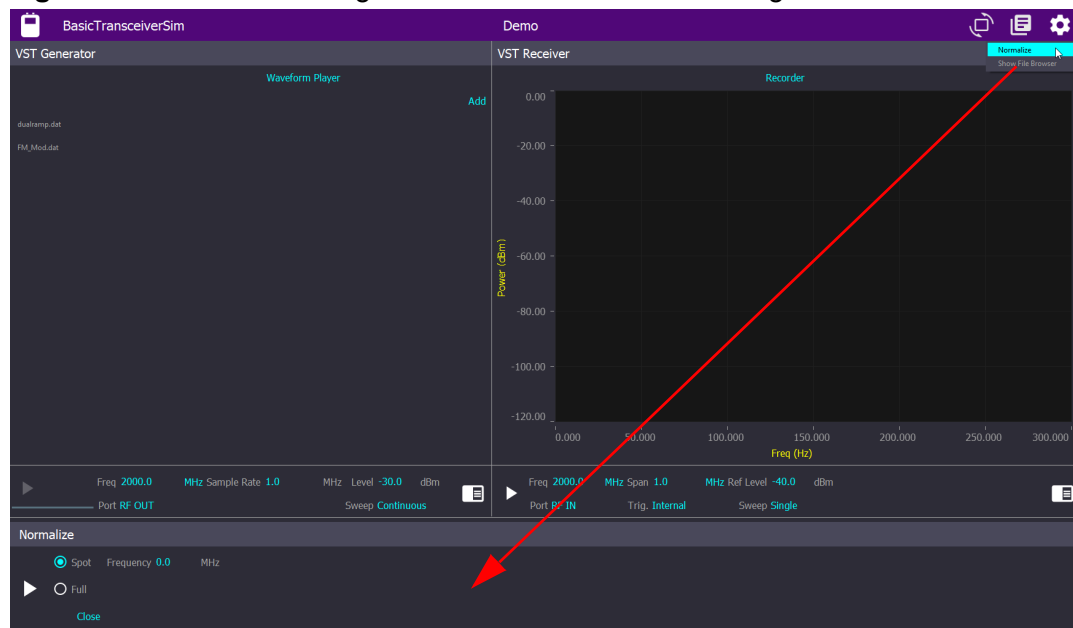

Normalize Power Warning

A dialog window will be generated to prompt the user to disconnect any connections from the VST before running normalize. To ensure proper normalization, prior to running the Normalize procedure, remove all external connections from the RF IN, RF OUT, and DUPLEX connectors on the VST.



NOTE

Failure to remove external signal sources may introduce inaccuracy in the normalize procedure due to leakage of the incident signal adding or subtracting in phase with the internal normalization source signal.

Spot Normalize

Spot Normalize performs a Normalization to optimize performance at a single frequency. Spot Normalization will only remain valid until it is performed again at a different frequency.

Figure 6-27 Spot Normalize Controls and Settings

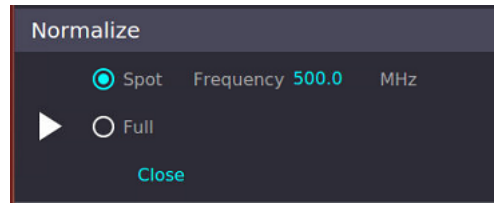

Frequency

Defines the frequency at which Spot Normalize will be performed.

Play Button

Starts the Spot Normalize process.

Stop Button

Stops the Spot Normalize process.

Close

Closes the Normalize control settings panel.

Full Normalize

Full Normalize performs a Normalization designed to re-align performance over the full frequency range of the VST.

Figure 6-28 Full Normalize Controls and Settings

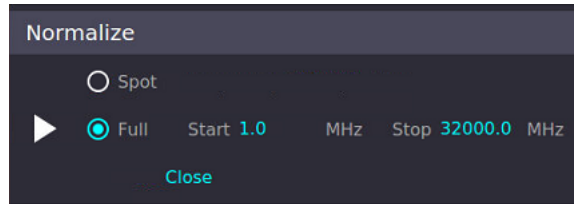

Start

Read-only field that defines the start frequency for Full Normalize.

Stop

Read-only field that defines the stop frequency for Full Normalize.

Play Button

Starts the Full Normalize process.

Stop Button

Stops the Full Normalize process.

Close

Closes the Normalize control settings panel.



NOTE

Do not interrupt system during Normalization, as this will cause a serious error and prevent proper function. The message "Normalize is in Process..." will be displayed while the normalize function is being performed.

Using the VST

Receiver Functions

This section describes how to configure the mA-6806 to perform the following functions:

- Display an incoming signal

How to Display an Incoming Signal

- 1 Connect the cable with the incoming signal to the mA-6806 RF Input or RF Duplex port. See [“RF Input/Output Connectors”](#) for more information.
- 2 Open the VST UI Client. See [“Opening the VST UI Client”](#) for more information.
- 3 Set recorder frequency, span and level to match the incoming signal. See [“Receiver Functions”](#) for more information.
- 4 Select desired input port. See [“Receiver Functions”](#) for more information.
- 5 Set trigger to internal, and sweep to continuous. See [“Receiver Functions”](#) for more information.
- 6 Press play.

Generator Functions

This section describes how to configure the mA-6806 to perform the following functions:

- Output a Continuous Wave Signal
- Output a waveform file

How to Output a Continuous Wave (CW) Signal

- 1 Connect cable from the RF Output or RF Duplex port to the desired device.
- 2 Open the VST UI Client.
- 3 Select Continuous Wave (CW) from Generator Mode Menu. See [“Waveform Player Controls and Settings”](#).
- 4 Configure the Generator output frequency, level and sample rate. See [“Generator Functions”](#) for more information.
- 5 Select the desired output port. See [“Generator Functions”](#) for more information.
- 6 Press play.

How to Output Waveform File

- 1 Connect cable from the RF Output or RF Duplex port to the desired device.
- 2 Open the VST UI Client.
- 3 Select Waveform Player from Generator Mode Menu. See [“Waveform Player Controls and Settings”](#) for more information.
- 4 Select waveform from list, or add desired waveform from file. See [“Waveform Player Controls and Settings”](#) for more information.
- 5 Configure the Generator output freq level and sample rate parameters. See [“Generator Functions”](#) for more information.
- 6 Select the desired output port. See [“Receiver Functions”](#) for more information.
- 7 Set sweep to continuous. See [“Generator Functions”](#) for more information.
- 8 Press play.



NOTE

Waveform files must be .dat to be generated from VST UI client.

Using Markers

Adding a Marker

A marker is added to a Plot Field by pressing the Add Marker Button.

Deleting Markers

A marker is deleted by pressing the "X" Button located on the Marker Measurement Bar.

Moving Markers

How to move a marker

- 1 Add a marker to the Plot Field. If more than one marker is present on the Plot Field, select the Marker that you wish to move.
- 2 Press the Left or Right Arrow Button to move the marker to the desired location on the signal trace.



NOTE

Markers can also be positioned on the plot field by selecting the marker and dragging and dropping the marker to a position on the plot field.

How to create a marker delta

- 1 Add a marker to the Plot Field. If more than one marker is present on the Plot Field, select the Marker that you wish to use as a reference point to create a marker delta.
- 2 Use the Marker Navigation Buttons to move the marker to the first point of the marker delta (delta reference point).



NOTE

The Delta Reference Point cannot be changed once the Delta has been created. To change a defined Delta Reference Point, delete the Marker from the Plot Field and restart the steps to Create a Marker Delta.

- 3 Press the Delta Button to establish the Marker's position as the delta reference point. The Marker Measurement Bar updates to display Delta Measurements.
- 4 Use the Marker Navigation Buttons to move the marker the desired distance from the Delta Reference Point.

This page intentionally left blank.

mA-6806 Care and Maintenance

This chapter contains instructions for the care and maintenance of the mA-6806.

Instructions cover the following topics:

- Maintaining the Device 7-2
 - Storing the Device 7-2
 - Visual Inspections 7-2
 - External cleaning 7-3
- Firmware/Software Updates 7-3
 - Updating Firmware/Software 7-3
 - VST Self Test Procedure 7-4
- Module Removal/Installation Procedures 7-5
 - Removing the Module 7-5
 - Module Installation Procedure 7-6
- Shipping the mA-6806 7-8
 - Return Authorization (RA) 7-8
 - Tagging the Device 7-8
 - Shipping Containers 7-8
 - Freight Costs 7-8
 - Packing Procedure 7-9

Maintaining the Device

The following procedures are operator level procedures that can be performed by the user. All other service must be performed by Qualified Service Personnel.



CAUTION

This device does not contain user serviceable parts. Servicing should only be performed by Qualified Service Personnel.

Mise en Garde

Cet appareil ne contient pas de pièces pouvant être entretenues par l'utilisateur. L'entretien doit seulement être effectué par du personnel de service qualifié.

Storing the Device

Module Installed in Chassis

To prepare the Chassis and module for long-term storage:

- Disconnect all accessory cords from Front and Rear Panel Connectors.
- Cover the connectors with suitable dust cover to prevent tarnishing of connector contacts.
- Refer to Chassis and module specifications for proper storage environment.

Module Removed from Chassis

To prepare the module for long-term storage:

- Remove module from Chassis.
- Place module in ESD protective packaging.
- Refer to module specifications for proper storage environment.

Visual Inspections

Visual inspections should be performed periodically depending on operating environment, maintenance and use.

- Inspect connectors for dirt, dust, corrosion or rust.
- Check the presence and condition of all warning labels and markings and supplied safety information.

External cleaning

The following procedure contains routine instructions for cleaning the exterior of the module.

- Remove grease, fungus and ground-in dirt from surfaces with soft lint-free cloth dampened (not soaked) with isopropyl alcohol.
- Remove dust and dirt from connectors with soft-bristled brush.

Firmware/Software Updates

The mA-6806 is shipped from the factory with the latest firmware/software installed in the module. Regular checks should be performed to ensure all system hardware contains the most current software, drivers and or firmware.

Contact VIAVI Customer Service to check for the latest version of software, firmware and/or drivers.

Updating Firmware/Software

Firmware and Software Upgrade Procedure

If the VST is installed in a chassis manufactured by a company other than VIAVI, the module must be updated using the Firmware and Software Upgrade Procedure. Refer to [Chapter 8 “Firmware and Software Upgrade Procedure”](#) for a link to the instructions to update the VST using the Firmware and Software Upgrade Procedure.

VST Self Test Procedure

Refer to the section titled “[Self Test Page](#)” on [page 5-5](#) for a detailed description of Self Test controls and settings.

Run All Self Test Procedures

- 1 Navigate to the Self Test Page (see [page 5-5](#)).
- 2 Press the Run All Button.
- 3 Wait while the module performs the self test procedure.

Run Specific Self Test Procedure

- 1 Navigate to the Self Test Page (see [page 5-5](#)).
- 2 Select the test(s) to be performed.
- 3 Press the Run Selected Button.
- 4 Wait while the module performs the selected self test procedure.

Module Removal/Installation Procedures

This section covers removing and installing the module. The procedures in this section are intended for Qualified Service Personnel.



CAUTION

Modules are ESD sensitive and should only be installed, removed and/or serviced by Qualified Service Personnel.

Mise en Garde

Les modules sont sensibles aux DES et ils doivent seulement être installés, enlevés ou entretenus par du personnel de service qualifié.

Removing the Module

How to Remove Module

- 1 Power down the Chassis.
- 2 Fully loosen the captive screws on each side of the module.
- 3 Grasp the module Securing Latches and pull the Latches outwards and away from the module to disconnect the module from the Backplane Connectors.
- 4 Pull until the Securing Latches are at a 90° angle with the front of the module. See [Figure 7-2 on page 7-7](#).
- 5 Grasp the module and pull to remove the module from the Chassis.

If the module is being returned to the factory for service, refer to section “[Shipping the mA-6806](#)” on [page 7-8](#) for important information.

Module Installation Procedure

The mA-6806 is designed for installation in an AXIe Chassis compliant to AXIe-1 Base Architecture Specification, Revision 3.0.



CAUTION

Modules are not "hot-swappable." The Chassis must be powered down before installing or removing modules from the Chassis.

Mise en Garde

Les modules ne peuvent pas être « changés lorsque sous tension. » Le châssis doit être mis hors tension avant d'installer ou d'enlever des modules du châssis.



CAUTION

Use care when installing modules to avoid damaging any modules already installed in the Chassis.

Mise en Garde

Faites attention lors de l'installation de modules afin d'éviter d'endommager les modules déjà installés dans le châssis.



CAUTION

Modules are ESD sensitive and should only be installed, removed and/or serviced by Qualified Service Personnel.

Mise en Garde

Les modules sont sensibles aux DES et ils doivent seulement être installés, enlevés ou entretenus par du personnel de service qualifié.

Preliminary Procedures

Verify the following before beginning installation:

- Slot does not contain foreign objects or debris.
- Chassis Backplane connector pins are not bent or damaged.

How to Install the Module

- 1 Power down the Chassis.
- 2 If the module has securing latches, position the latches at a 90° angle to the front of the module.



NOTE

The securing latch must be placed in the unlocked position - pulled out and away from the latch mechanism - or module cannot be properly inserted and seated with the Chassis backplane connectors.

Figure 7-1 Securing Latch - Locked Position



Figure 7-2 Securing Latch - Unlocked Position



Figure 7-3 Securing Latch - Unlocked and Unlatched



- 3 Position the module on the Chassis Side Rails. Slide the module into the card cage.



NOTE

If the module does not slide smoothly along the side rails, remove the module, realign and reinsert the module.

- 4 Fully insert the module into Card Cage. Press firmly to securely connect module pins with Backplane Assembly Connectors.
- 5 Press the securing latches into the Locked Position.
- 6 Hand tighten the captive screw on each side of module. Securely tighten each captive screw to ensure module is properly grounded via the Chassis.

Shipping the mA-6806

Any device returned to factory for calibration, service or repair must be repackaged and shipped subject to the following conditions:

Return Authorization (RA)

Do not return any products to the factory without prior authorization from VIAVI Customer Service.

Tagging the Device

All items shipped to VIAVI must be tagged with:

- Owner's Identification and contact information
- Nature of service or repair needed
- Model Number and Serial Number
- Return Authorization (RA) Number

Shipping Containers

Devices must be repackaged in original shipping containers using VIAVI packing materials. If original shipping containers and materials are not available, contact VIAVI Customer Service for shipping instructions.

Freight Costs

All freight costs on non-warranty shipments are assumed by the customer. VIAVI recommends that customers obtain freight insurance with the freight carrier when shipping the device.



NOTE

VIAVI is not responsible for the cost of repairs for damages that occur during shipment on warranty or non-warranty items.

Packing Procedure

Devices must be repackaged in original shipping containers using VIAVI packing materials. If original shipping containers and materials are not available, contact VIAVI Customer Service for shipping instructions.



NOTE

VIAVI is not responsible for the cost of repairs for damages that occur during shipment on warranty or non-warranty items.

Contact Customer Service to obtain a Return Authorization number, return address and for questions about proper packaging.

Packaging Procedure

- 1 Place module in ESD protective packaging/envelope.
- 2 Place module between foam inserts.
- 3 Place secured module in shipping container
- 4 Seal shipping container for shipment.

This page intentionally left blank.

Firmware and Software Upgrade Procedure

The Firmware and Software Upgrade Procedure provides step-by-step instructions for performing a full System CMP BIOS Installation, Scrape Disc Upgrade Instructions, and Signal WorkShop (SWS) Software Update Procedure.

**NOTE**

Read this procedure in its entirety before proceeding.

Select the following link to access the Firmware and Software Upgrade Procedure:

<https://www.viavisolutions.com/en-us/literature/ranger-firmware-and-software-upgrade-procedure-software-and-firmware-releases-en.pdf>

This page intentionally left blank.

mA-6806 Safety and Compliance Specifications

This section contains product safety and compliance specifications for the mA-6806 Vector Signal Transceiver. Refer to the mA-6806 Vector Signal Transceiver Data Sheet for complete product specifications.

- [Unit Specifications](#) A-2
- [Environmental Specifications](#) A-2
- [Electrical Specifications](#) A-3
- [Regulatory Standards and Compliance](#) A-3

Unit Specifications

Table A-1 mA-6806 Physical specifications

Parameter	Specification
Height	30 mm
Width	280 mm
Depth	322.5 mm
Weight	1.9 kg
Form Factor	1 slot AXIe

Environmental Specifications

Tested in accordance with MIL-PRF-28800F, Class 3

Table A-2 Operating and storage environment

Parameter	Specification
Operating Temperature	15°C to 75°C
Storage Temperature	-40°C to 71°C
Warm-up Time	30 minutes
Humidity	95% at 40°C
Altitude	3,000 m (9,842 ft)
Functional Shock	30 G
Random Vibration	5 to 500 Hz random

Electrical Specifications

Table A-3 Power Requirements

Connector	Specification
Operating Voltage	48 VDC
Power Dissipation	≤ 100 W

Table A-4 Maximum Input Level

Connector	Specification
RF Input Connector	SMA Type Connector +10 dBm, ± 16 Vdc
RF Duplex Input Connector	SMA Type Connector +40 dBm, ± 0 Vdc
Trigger Input Connectors	SMB Type Connectors Specifications apply to Trigger Input Connectors A:D +3.3 V CMOS, -0.2 to +5 V Tolerant

Regulatory Standards and Compliance

Table A-5 Compliance Standard

AXIe-1 Base Architecture Specification, Revision 3
ATCA PICMG 3.0 Revision 3.0 Specification

Table A-6 EMC Compliance

MIL-PRF-28800F Class 3
IEC/EN 61326-1
IEC/EN 61000-3-2
IEC/EN 61000-3-3

Table A-7 Safety Standards

IEC/EN 61010-1

This page intentionally left blank.

Ranger Manual Validation Test Procedure



NOTE

Read this procedure in its entirety before proceeding.

Ranger Manual Validation Test Procedure



1 Overview

This procedure is intended to verify that your 6 GHz Ranger system is operating properly. This procedure can be used to test a 6 GHz Ranger System.

This procedure is intended for personnel who are familiar with test and measurement procedures and with the operational capabilities of the Ranger System.

The intended Ranger user interface unless otherwise stated (e.g. web interface for frequency calibration) is Signal WorkShop (SWS), therefore familiarity with SWS is also presumed.

2 Preliminary Procedures

Perform the following steps prior to starting this procedure:

1. Verify Ambient Temperature is between 25° C and 35° C.
2. Warm up the Ranger for 30 minutes before initiating the procedure.
3. Run the Full Normalize procedure (located in the VST GUI).

3 Test Data Sheet

Test data sheet has been included for your use; the data sheet is located at the end of this procedure.

4 Required Equipment

Table 1 identifies the equipment required to perform mA-6806 Verification Procedures. Other equipment meeting the specifications of the equipment listed may be substituted for the recommended models.

Equipment is specified to support testing 6 GHz and 30 GHz Ranger Systems. When testing a 6 GHz Ranger system, lower frequency test equipment can be substituted.

Table 1 Required Tool / Equipment

Make	Model/Options	Qty
Rohde & Schwarz	FSW50 Signal/ RF Spectrum Analyzer <ul style="list-style-type: none"> FSW-K40 Phase noise measurement application FSW-K50 Spurious measurements 	1
Rohde & Schwarz	SMB100A RF Signal Generator <ul style="list-style-type: none"> SMB-B140 Frequency range: 100 kHz to 40 GHz SMB-B1H OCXO high performance SMB-B32 High output power for R&S@SMB-B140/-B140L SMB-B26 Low harmonic filter for R&S@SMB-B140,-B140L 	2
Rohde & Schwarz	NRP33SN USB/LAN RF Power Sensor <ul style="list-style-type: none"> NRP-ZKU USB cable (1.5m) for NRPxxS/T/A/SN/TN/AN; for Laptop/PC 	1
Rohde & Schwarz	NRP-Z91 RF Power Meter <ul style="list-style-type: none"> NRP-Z4 USB Adapter 	1
Rohde & Schwarz	FSMR26 Measuring Receiver <ul style="list-style-type: none"> FS-K40 phase noise measurements FSMR-B223 YIG preselection with 20 dB preamplifier FSU-B25 Electronic attenuator 0 to 30 dB, Preamplifier 20 dB FSU-B4 OCXO 10 MHz NRP-Z27 Power sensor module DC to 18 GHz 	1
Microwave Comm. Labs	PS2-93, 2-Way Power Divider and Combiner	1
RF Centric	C8154, 1.85mm Female to 2.92mm Male Adapter	8
Times Microwave	SLSV50-24M24M-02.00f, Microwave Assembly Cable	3
	GPS based 10 MHz Frequency Reference (referred to in test procedures as 10 MHz Freq Ref)	1

5 Verification Procedures

5.1 Frequency Accuracy Tests

5.1.1 RF Output and OCXO Frequency Accuracy

Prerequisites: Preliminary Procedures

Equipment: FSMR26 Measuring Receiver
10 MHz Freq Ref

Table 1 RF Output Frequency Accuracy Test Frequencies

Step / Procedure

- 1) Connect the FSMR26 to 10 MHz Freq Ref.
- 2) Connect FSMR26 Input to Ranger RF Output Port.
- 3) Connect Ranger to 10 MHz Freq Ref.
- 4) Set Ranger Frequency Reference Clock to External (Location Tab in Signal WorkShop™).
- 5) Set the Ranger Vector Signal Player (VSP) settings as follows:
 - Port to RF Out.
 - Transmit Level to 0 dBm.
 - Create and select a CW waveform, then select for play.
- 6) Set the Ranger VSP RF Output Frequency to the first value listed in Table 2.
- 7) Verify the Ranger transmit frequency falls within limits indicated in test data sheet.
- 8) Repeat steps 7 and 8 for each frequency in Table 2.
- 9) While the generator is still transmitting the last frequency (6GHz), remove the 10MHz reference and wait for the frequency to settle.
- 10) Verify that the frequency is within $\pm 600\text{Hz}$ ($\pm 0.1\text{ppm}$ at 6GHz).
- 11) If it does not:
 - a) Open an internet browser on the Ranger system.
 - b) Redirect the browser to the chassis web page (i.e. by entering the chassis IP address)
 - c) Click the 3 lines on the top left (the "hamburger") and select the "person" icon from the menu (third from the left - [see Figure 1]) to access the OCXO adjustment. Enter the password "Cmpadmin76" and press Submit to access this screen.

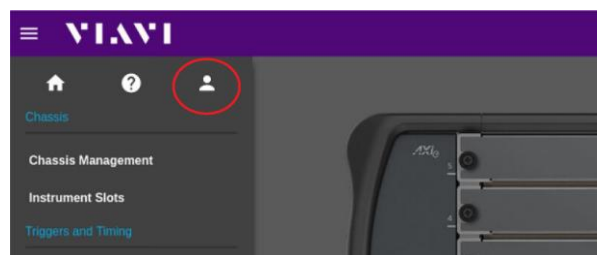

Figure 1: Person Icon

Step / Procedure

12) Adjust the slider until the reading in step 10 passes, record the adjusted value, and press "Apply".
You may now exit this screen.

Table 2 RF Output Frequency Accuracy Test Frequencies

1.0 MHz	1000 MHz	3299 MHz	6000 MHz
200 MHz	3000 MHz	5699 MHz	

5.1.2 RF Input Frequency Accuracy

Prerequisites: This test presumes 5.1.1 has been successfully performed

Equipment: 10 MHz Freq Ref

Step / Procedure

- 1) Connect a coax from the RF Output to the RF Input on the Ranger's mA-6806
- 2) Connect Ranger to 10 MHz Freq Ref.
- 3) Set Ranger Frequency Reference Clock to External (Location Tab in Signal WorkShop™).
- 4) Set the Ranger Vector Signal Player (VSP) settings as follows:
 - Port to RF Out.
 - Transmit Level to 0 dBm.
 - Create and select a CW waveform, then select for play.
- 5) Set the Ranger Signal View Toolkit (SVT) settings as follows:
 - Port to RF IN.
 - Transmit Level to 0 dBm.
 - Bandwidth to 10MHz
 - Monitor (MON)
 - Select AM/FM/PM analysis instrument and select the following settings:
 - Set Input Signal Modulation to FM
 - Set Input Signal Frequency Resolution to 1Hz
 - Only turn on the Settings and Stats (to speed up refresh)
 - Set Preselector Pass Band Bandwidth and Input Signal Center Frequency to the Frequencies listed in Table 3
- 6) Set the Ranger VSP RF Output Frequency and SVT RF Input Frequency to the first value listed in Table 3.
- 7) Verify the AM/FM/PM Center Frequency Error falls within limits indicated in test data sheet.
- 8) Repeat steps 7 and 8 for each frequency in Table 3.

Table 3 RF Input Frequency Accuracy

50 MHz	1000 MHz	3299 MHz	6000 MHz
200 MHz	3000 MHz	5699 MHz	

5.2 RF Output Amplitude Accuracy

Prerequisites: Preliminary Procedures

Equipment: NRP-Z91 Power Meter (levels > -20 dBm, up to 6 GHz)

FSMR26 Measuring Receiver (levels < -20 dBm)

Step / Procedure

- 1) Depending on the level being measured (reference the equipment list), connect either the NRP-Z91 or FSMR26 to the Ranger RF Output port.
- 2) Set the Ranger Vector Signal Player (VSP) RF Port to RF Out.
- 3) Set the VSP Ranger RF Output Frequency and Transmit Level to the first set of values in Table 4
- 4) Verify the Ranger transmit power is within the limits noted in test data sheet.
- 5) Repeat steps 3 and 4 for each frequency/level combination in Table 4.

Table 4 RF Output Amplitude Accuracy

49 MHz to 512 MHz Band								
Freq (MHz)	Level (dBm)	✓	Freq (MHz)	Level (dBm)	✓	Freq (MHz)	Level (dBm)	✓
49	+9		100	+7		512	+9	
49	-1		100	-3		512	-1	
49	-11		100	-13		512	-11	
49	-21		100	-23		512	-21	
49	-31		100	-33		512	-31	
49	-41		100	-43		512	-41	
49	-51		100	-53		512	-51	
49	-61		100	-63		512	-61	
49	-71		100	-73		512	-71	
49	-81		100	-83		512	-81	
49	-91		100	-93		512	-91	
49	-101		100	-103		512	-101	
49	-110		100	-110		512	-110	
1101 MHz to 2501 MHz Band								
Freq (MHz)	Level (dBm)	✓	Freq (MHz)	Level (dBm)	✓	Freq (MHz)	Level (dBm)	✓
1101	+2		1501	+9		2501	+3	
1101	-8		1501	-1		2501	-7	
1101	-18		1501	-11		2501	-17	
1101	-28		1501	-21		2501	-27	
1101	-38		1501	-31		2501	-37	
1101	-48		1501	-41		2501	-47	

1101	-58		1501	-51		2501	-57	
1101	-68		1501	-61		2501	-67	
1101	-78		1501	-71		2501	-77	
1101	-88		1501	-81		2501	-87	
1101	-98		1501	-91		2501	-97	
1101	-108		1501	-101		2501	-107	
1101	-115		1501	-110		2501	-110	

3501 MHz to 5501 MHz

Freq (MHz)	Level (dBm)	✓	Freq (MHz)	Level (dBm)	✓	Freq (MHz)	Level (dBm)	✓
3501	+10		4501	+9		5501	+8	
3501	0		4501	-1		5501	-2	
3501	-10		4501	-11		5501	-12	
3501	-20		4501	-21		5501	-22	
3501	-30		4501	-31		5501	-32	
3501	-40		4501	-41		5501	-42	
3501	-50		4501	-51		5501	-52	
3501	-60		4501	-61		5501	-62	
3501	-70		4501	-71		5501	-72	
3501	-80		4501	-81		5501	-82	
3501	-90		4501	-91		5501	-92	
3501	-100		4501	-101		5501	-102	
3501	-110		4501	-110		5501	-110	

6000 MHz

Freq (MHz)	Level (dBm)	✓	Freq (MHz)	Level (dBm)	✓	Freq (MHz)	Level (dBm)	✓
6000	+2		6000	-48		6000	-88	
6000	-8		6000	-58		6000	-98	
6000	-18		6000	-68		6000	-108	
6000	-28		6000	-78		6000	-118	
6000	-38							

5.3 Duplex Output Amplitude Accuracy

Prerequisites: Preliminary Procedures

Equipment: FSMR26 Measuring Receiver

Step / Procedure

- 1) Connect the FSMR26 to the Ranger Duplex Port.
- 2) Set the Ranger Vector Signal Player (VSP) RF Port to Duplex.
- 3) Set the VSP Ranger RF Output Frequency and Transmit Level to the first set of values in Table 5.
- 4) Verify the Ranger Transmit power is within the limits noted in test data sheet.
- 5) Repeat steps 3 and 4 for each frequency/level combination in Table 5 **Error! Reference source not found..**

Table 5 Duplex Output Amplitude Accuracy Test Frequency/Level Settings

49 MHz to 512 MHz Band								
Freq (MHz)	Level (dBm)	✓	Freq (MHz)	Level (dBm)	✓	Freq (MHz)	Level (dBm)	✓
49	-35		100	-30		512	-35	
49	-45		100	-40		512	-45	
49	-55		100	-50		512	-55	
49	-65		100	-60		512	-65	
49	-75		100	-70		512	-75	
49	-85		100	-80		512	-85	
49	-95		100	-90		512	-95	
49	-105		100	-100		512	-105	
49	-115		100	-110		512	-115	
49	-120		100	-120		512	-120	
1000 MHz to 2501 MHz Band								
Freq (MHz)	Level (dBm)	✓	Freq (MHz)	Level (dBm)	✓	Freq (MHz)	Level (dBm)	✓
1101	-30		1501	-35		2501	-30	
1101	-40		1501	-45		2501	-40	
1101	-50		1501	-55		2501	-50	
1101	-60		1501	-65		2501	-60	
1101	-70		1501	-75		2501	-70	
1101	-80		1501	-85		2501	-80	
1101	-90		1501	-95		2501	-90	
1101	-100		1501	-105		2501	-100	
1101	-110		1501	-115		2501	-110	
1101	-120		1501	-120		2501	-120	

3501 MHz to 5501 MHz Band								
Freq (MHz)	Level (dBm)	✓	Freq (MHz)	Level (dBm)	✓	Freq (MHz)	Level (dBm)	✓
3501	-35		4501	-30		5501	-35	
3501	-45		4501	-40		5501	-45	
3501	-55		4501	-50		5501	-55	
3501	-65		4501	-60		5501	-65	
3501	-75		4501	-70		5501	-75	
3501	-85		4501	-80		5501	-85	
3501	-95		4501	-90		5501	-95	
3501	-105		4501	-100		5501	-105	
3501	-115		4501	-110		5501	-115	
3501	-120		4501	-120		5501	-120	
6000 MHz Band								
Freq (MHz)	Level (dBm)	✓	Freq (MHz)	Level (dBm)	✓	Freq (MHz)	Level (dBm)	✓
6000	-30		6000	-70		6000	-100	
6000	-40		6000	-80		6000	-110	
6000	-50		6000	-90		6000	-120	
6000	-60							

5.4 RF Output Harmonic Spurious

Prerequisites: Preliminary Procedures

Equipment: FSW50 Spectrum/Signal Analyzer

Step / Procedure

- 1) Connect the FSW50 to the Ranger RF Output Port.
- 2) Set the Ranger Vector Signal Player (VSP) settings as follows:
 - RF Port to RF Out.
 - RF Level to 0 dBm.
- 3) Set the Ranger VSP RF Output Frequency to the first value in Table 6.
- 4) Verify the Ranger harmonic level dBc value does not exceed the level noted in the test data sheet for each harmonic.
- 5) Repeat steps 4 and 5 for each frequency in Table 6.

Table 6 RF Output Harmonic Spurious Test Frequencies

200 MHz	1800 MHz	3200 MHz	4800 MHz
400 MHz	2000 MHz	3400 MHz	5000 MHz
600 MHz	2200 MHz	3600 MHz	5200 MHz
800 MHz	2400 MHz	3800 MHz	5400 MHz
1000 MHz	2600 MHz	4000 MHz	5600 MHz
1200 MHz	2800 MHz	4200 MHz	5800 MHz
1400 MHz	3000 MHz	4400 MHz	6000 MHz
1600 MHz			

5.5 RF Output SSB Phase Noise

Prerequisites: Preliminary Procedures

Equipment: FSW50 Spectrum/Signal Analyzer

Step / Procedure

- 1) Connect the FSW50 to the Ranger RF Output Port.
- 2) Set the Ranger Vector Signal Player (VSP) settings as follows:
 - RF Port to RF Out.
 - RF Level to 0 dBm.
- 3) Set the Ranger VSP RF Output Frequency to the first value in Table 7.
- 4) Verify the Ranger SSB level dBc/Hz value does not exceed the level (offsets as noted) in test data sheet.
- 5) Repeat steps 4 and 5 for each frequency/offset combination in Table 7. **Error! Reference source not found..**

Table 7 RF Output Single Sideband (SSB) Phase Noise

Frequency (MHz)	Offset	✓	Frequency (MHz)	Offset	✓
900	1 MHz		2900	1 MHz	
900	10 kHz		2900	10 kHz	
900	1 kHz		2900	1 kHz	
1900	1 MHz		5900	1 MHz	
1900	10 kHz		5900	10 kHz	
1900	1 kHz		5900	1 kHz	

5.6 RF Input Amplitude Accuracy

Prerequisites: Preliminary Procedures

Equipment: SMB100A RF Signal Generator

Step / Procedure

- 1) Connect a SMB100A to the Ranger RF Input Port.
- 2) Set Ranger RF Input to RF In.
- 3) Set Ranger Bandwidth to 100 MHz (125M samples/sec).
- 4) Set the following to the first set of values in Table 8.
 - Ranger Receive Frequency
[NOTE: For 1MHz measurements only, use a center frequency of 50MHz (1MHz will be visible at the far left because the selected span will be 100MHz). For all other frequencies, use the frequency being measured as the center frequency.]
 - SMB100A Output Level
 - Ranger Input Level
- 5) Open Signal WorkShop Signal View Toolkit (SVT). Use Peak Marker function to verify values in test data sheet.
- 6) Repeat steps 4 and 5 for each group of frequency/level settings in Table 8.

NOTE: Do not confuse the *display level* on the Spectrum display with *Input Level*, which is a setting located next to the receive frequency in the top middle area on the SVT mode tab.

Table 8 RF Input Amplitude Accuracy Test Points

1 MHz to 75 MHz							
Freq (MHz)	SMB100A Output Level	Ranger Input Level	✓	Freq (MHz)	SMB100A Output Level	Ranger Input Level	✓
1	+9	+10 dBm		75	+9	+10 dBm	
1	+7	+10 dBm		75	+7	+10 dBm	
1	+5	+10 dBm		75	+5	+10 dBm	
1	+3	+10 dBm		75	+3	+10 dBm	
1	+1	+10 dBm		75	+1	+10 dBm	
1	-1	0 dBm		75	-1	0 dBm	
1	-3	0 dBm		75	-3	0 dBm	
1	-5	0 dBm		75	-5	0 dBm	
1	-7	0 dBm		75	-7	0 dBm	
1	-9	0 dBm		75	-9	0 dBm	
1	-11	-10 dBm		75	-11	-10 dBm	
1	-20	-10 dBm		75	-20	-10 dBm	
1	-30	-20 dBm		75	-30	-20 dBm	
1	-40	-20 dBm		75	-40	-20 dBm	

1	-51	-20 dBm		75	-51	-20 dBm	
1	-60	-20 dBm		75	-60	-20 dBm	
1	-70	-70 dBm		75	-70	-70 dBm	
1	-80	-70 dBm		75	-80	-70 dBm	
100 MHz to 500 MHz							
Freq (MHz)	SMB100A Output Level	Ranger Input Level	✓	Freq (MHz)	SMB100A Output Level	Ranger Input Level	✓
100	+9	+10 dBm		500	+9	+10 dBm	
100	+7	+10 dBm		500	+7	+10 dBm	
100	+5	+10 dBm		500	+5	+10 dBm	
100	+3	+10 dBm		500	+3	+10 dBm	
100	+1	+10 dBm		500	+1	+10 dBm	
100	-1	0 dBm		500	-1	0 dBm	
100	-3	0 dBm		500	-3	0 dBm	
100	-5	0 dBm		500	-5	0 dBm	
100	-7	0 dBm		500	-7	0 dBm	
100	-9	0 dBm		500	-9	0 dBm	
100	-11	-10 dBm		500	-11	-10 dBm	
100	-20	-10 dBm		500	-20	-10 dBm	
100	-30	-20 dBm		500	-30	-20 dBm	
100	-40	-20 dBm		500	-40	-20 dBm	
100	-51	-20 dBm		500	-51	-20 dBm	
100	-60	-20 dBm		500	-60	-20 dBm	
100	-70	-70 dBm		500	-70	-70 dBm	
100	-80	-70 dBm		500	-80	-70 dBm	

700 MHz to 900 MHz							
Freq (MHz)	SMB100A Output Level	Ranger Input Level	✓	Freq (MHz)	SMB100A Output Level	Ranger Input Level	✓
700	+9	+10 dBm		900	+9	+10 dBm	
700	+7	+10 dBm		900	+7	+10 dBm	
700	+5	+10 dBm		900	+5	+10 dBm	
700	+3	+10 dBm		900	+3	+10 dBm	
700	+1	+10 dBm		900	+1	+10 dBm	
700	-1	0 dBm		900	-1	0 dBm	
700	-3	0 dBm		900	-3	0 dBm	
700	-5	0 dBm		900	-5	0 dBm	
700	-7	0 dBm		900	-7	0 dBm	
700	-9	0 dBm		900	-9	0 dBm	
700	-11	-10 dBm		900	-11	-10 dBm	
700	-20	-10 dBm		900	-20	-10 dBm	
700	-30	-20 dBm		900	-30	-20 dBm	
700	-40	-20 dBm		900	-40	-20 dBm	
700	-51	-20 dBm		900	-51	-20 dBm	
700	-60	-20 dBm		900	-60	-20 dBm	
700	-70	-70 dBm		900	-70	-70 dBm	
700	-80	-70 dBm		900	-80	-70 dBm	
1000 MHz to 5100 MHz							
Freq (MHz)	SMB100A Output Level	Ranger Input Level	✓	Freq (MHz)	SMB100A Output Level	Ranger Input Level	✓
1000	+9	+10 dBm		1500	+9	+10 dBm	
1000	+7	+10 dBm		1500	+7	+10 dBm	
1000	+5	+10 dBm		1500	+5	+10 dBm	
1000	+3	+10 dBm		1500	+3	+10 dBm	
1000	+1	+10 dBm		1500	+1	+10 dBm	
1000	-1	0 dBm		1500	-1	0 dBm	
1000	-3	0 dBm		1500	-3	0 dBm	
1000	-5	0 dBm		1500	-5	0 dBm	
1000	-7	0 dBm		1500	-7	0 dBm	
1000	-9	0 dBm		1500	-9	0 dBm	
1000	-11	-10 dBm		1500	-11	-10 dBm	
1000	-20	-10 dBm		1500	-20	-10 dBm	

1000	-30	-20 dBm		1500	-30	-20 dBm	
1000	-40	-20 dBm		1500	-40	-20 dBm	
1000	-51	-20 dBm		1500	-51	-20 dBm	
1000	-60	-20 dBm		1500	-60	-20 dBm	
1000	-70	-70 dBm		1500	-70	-70 dBm	
1000	-80	-70 dBm		1500	-80	-70 dBm	
2000 MHz to 5200 MHz							
Freq (MHz)	SMB100A Output Level	Ranger Input Level	✓	Freq (MHz)	SMB100A Output Level	Ranger Input Level	✓
2000	+9	+10 dBm		2500	+9	+10 dBm	
2000	+7	+10 dBm		2500	+7	+10 dBm	
2000	+5	+10 dBm		2500	+5	+10 dBm	
2000	+3	+10 dBm		2500	+3	+10 dBm	
2000	+1	+10 dBm		2500	+1	+10 dBm	
2000	-1	0 dBm		2500	-1	0 dBm	
2000	-3	0 dBm		2500	-3	0 dBm	
2000	-5	0 dBm		2500	-5	0 dBm	
2000	-7	0 dBm		2500	-7	0 dBm	
2000	-9	0 dBm		2500	-9	0 dBm	
2000	-11	-10 dBm		2500	-11	-10 dBm	
2000	-20	-10 dBm		2500	-20	-10 dBm	
2000	-30	-20 dBm		2500	-30	-20 dBm	
2000	-40	-20 dBm		2500	-40	-20 dBm	
2000	-51	-20 dBm		2500	-51	-20 dBm	
2000	-60	-20 dBm		2500	-60	-20 dBm	
2000	-70	-70 dBm		2500	-70	-70 dBm	
2000	-80	-70 dBm		2500	-80	-70 dBm	

3000 MHz to 3500 MHz							
Freq (MHz)	SMB100A Output Level	Ranger Input Level	✓	Freq (MHz)	SMB100A Output Level	Ranger Input Level	✓
3000	+9	+10 dBm		3500	+9	+10 dBm	
3000	+7	+10 dBm		3500	+7	+10 dBm	
3000	+5	+10 dBm		3500	+5	+10 dBm	
3000	+3	+10 dBm		3500	+3	+10 dBm	
3000	+1	+10 dBm		3500	+1	+10 dBm	
3000	-1	0 dBm		3500	-1	0 dBm	
3000	-3	0 dBm		3500	-3	0 dBm	
3000	-5	0 dBm		3500	-5	0 dBm	
3000	-7	0 dBm		3500	-7	0 dBm	
3000	-9	0 dBm		3500	-9	0 dBm	
3000	-11	-10 dBm		3500	-11	-10 dBm	
3000	-20	-10 dBm		3500	-20	-10 dBm	
3000	-30	-20 dBm		3500	-30	-20 dBm	
3000	-40	-20 dBm		3500	-40	-20 dBm	
3000	-51	-20 dBm		3500	-51	-20 dBm	
3000	-60	-20 dBm		3500	-60	-20 dBm	
3000	-70	-70 dBm		3500	-70	-70 dBm	
3000	-80	-70 dBm		3500	-80	-70 dBm	
4000 MHz to 4500 MHz							
Freq (MHz)	SMB100A Output Level	Ranger Input Level	✓	Freq (MHz)	SMB100A Output Level	Ranger Input Level	✓
4000	+9	+10 dBm		4500	+9	+10 dBm	
4000	+7	+10 dBm		4500	+7	+10 dBm	
4000	+5	+10 dBm		4500	+5	+10 dBm	
4000	+3	+10 dBm		4500	+3	+10 dBm	
4000	+1	+10 dBm		4500	+1	+10 dBm	
4000	-1	0 dBm		4500	-1	0 dBm	
4000	-3	0 dBm		4500	-3	0 dBm	
4000	-5	0 dBm		4500	-5	0 dBm	
4000	-7	0 dBm		4500	-7	0 dBm	
4000	-9	0 dBm		4500	-9	0 dBm	
4000	-11	-10 dBm		4500	-11	-10 dBm	
4000	-20	-10 dBm		4500	-20	-10 dBm	

4000	-30	-20 dBm		4500	-30	-20 dBm	
4000	-40	-20 dBm		4500	-40	-20 dBm	
4000	-51	-20 dBm		4500	-51	-20 dBm	
4000	-60	-20 dBm		4500	-60	-20 dBm	
4000	-70	-70 dBm		4500	-70	-70 dBm	
4000	-80	-70 dBm		4500	-80	-70 dBm	
5000 MHz to 5500 MHz							
Freq (MHz)	SMB100A Output Level	Ranger Input Level	✓	Freq (MHz)	SMB100A Output Level	Ranger Input Level	✓
5000	+9	+10 dBm		5500	+9	+10 dBm	
5000	+7	+10 dBm		5500	+7	+10 dBm	
5000	+5	+10 dBm		5500	+5	+10 dBm	
5000	+3	+10 dBm		5500	+3	+10 dBm	
5000	+1	+10 dBm		5500	+1	+10 dBm	
5000	-1	0 dBm		5500	-1	0 dBm	
5000	-3	0 dBm		5500	-3	0 dBm	
5000	-5	0 dBm		5500	-5	0 dBm	
5000	-7	0 dBm		5500	-7	0 dBm	
5000	-9	0 dBm		5500	-9	0 dBm	
5000	-11	-10 dBm		5500	-11	-10 dBm	
5000	-20	-10 dBm		5500	-20	-10 dBm	
5000	-30	-21 dBm		5500	-30	-21 dBm	
5000	-40	-21 dBm		5500	-40	-21 dBm	
5000	-51	-21 dBm		5500	-51	-21 dBm	
5000	-60	-21 dBm		5500	-60	-21 dBm	
5000	-70	-70 dBm		5500	-70	-70 dBm	
5000	-80	-70 dBm		5500	-80	-70 dBm	

6000 MHz							
Freq (MHz)	SMB100A Output Level	Ranger Input Level	✓	Freq (MHz)	SMB100A Output Level	Ranger Input Level	✓
6000	+9	+10 dBm		6000	-9	0 dBm	
6000	+7	+10 dBm		6000	-11	-10 dBm	
6000	+5	+10 dBm		6000	-20	-10 dBm	
6000	+3	+10 dBm		6000	-30	-21 dBm	
6000	+1	+10 dBm		6000	-40	-21 dBm	
6000	-1	0 dBm		6000	-51	-21 dBm	
6000	-3	0 dBm		6000	-60	-21 dBm	
6000	-5	0 dBm		6000	-70	-70 dBm	
6000	-7	0 dBm		6000	-80	-70 dBm	

5.7 Duplex Input Amplitude Accuracy

Prerequisites: Perform Preliminary Procedure

Equipment: SMB100A RF Signal Generator

Step / Procedure

- 1) Connect a SMB100A RF Signal Generator to the Ranger Duplex Port.
- 2) Set Ranger RF Input to Duplex.
- 3) Set Ranger Bandwidth to 100 MHz (125M samples/sec).
- 4) Set the following to the first set of values in Table 9.
 - Ranger Receive Frequency
[NOTE: For 1MHz measurements only, use a center frequency of 50MHz (1MHz will be visible at the far left because the selected span will be 100MHz). For all other frequencies, use the frequency being measured as the center frequency.]
 - SMB100A Output Level
 - Ranger Input Level
- 5) Open Signal WorkShop Signal View Toolkit (SVT). Use Peak Marker function to verify value in Table 9.
- 6) Repeat step 4 and 5 for each group of frequency/levels values in Table 9.

NOTE: Do not confuse the *display level* on the Spectrum display with *Input Level*, which is a setting located next to the receive frequency in the top middle area on the SVT mode tab.

Table 9 Duplex Input Amplitude Accuracy

1 MHz to 75 MHz							
Freq (MHz)	SMB100A Output Level	Ranger Input Level	✓	Freq (MHz)	SMB100A Output Level	Ranger Input Level	✓
1	+19	0 dBm		75	+19	0 dBm	
1	+9	-10 dBm		75	+9	-10 dBm	
1	-1	-20 dBm		75	-1	-20 dBm	
1	-11	-20 dBm		75	-11	-20 dBm	
1	-20	-20 dBm		75	-20	-20 dBm	
1	-30	-20 dBm		75	-30	-20 dBm	
1	-40	-20 dBm		75	-40	-20 dBm	
1	-51	-70 dBm		75	-51	-70 dBm	

100 MHz to 500 MHz							
Freq (MHz)	SMB100A Output Level	Ranger Input Level	✓	Freq (MHz)	SMB100A Output Level	Ranger Input Level	✓
100	+19	0 dBm		500	+19	0 dBm	
100	+9	-10 dBm		500	+9	-10 dBm	
100	-1	-20 dBm		500	-1	-20 dBm	
100	-11	-20 dBm		500	-11	-20 dBm	
100	-20	-20 dBm		500	-20	-20 dBm	
100	-30	-20 dBm		500	-30	-20 dBm	
100	-40	-20 dBm		500	-40	-20 dBm	
100	-51	-70 dBm		500	-51	-70 dBm	
700 MHz to 900 MHz							
Freq (MHz)	SMB100A Output Level	Ranger Input Level	✓	Freq (MHz)	SMB100A Output Level	Ranger Input Level	✓
700	+19	0 dBm		900	+19	0 dBm	
700	+9	-10 dBm		900	+9	-10 dBm	
700	-1	-20 dBm		900	-1	-20 dBm	
700	-11	-20 dBm		900	-11	-20 dBm	
700	-20	-20 dBm		900	-20	-20 dBm	
700	-30	-20 dBm		900	-30	-20 dBm	
700	-40	-20 dBm		900	-40	-20 dBm	
700	-51	-70 dBm		900	-51	-70 dBm	
1000 MHz to 5100 MHz							
Freq (MHz)	SMB100A Output Level	Ranger Input Level	✓	Freq (MHz)	SMB100A Output Level	Ranger Input Level	✓
1000	+19	0 dBm		1500	+19	0 dBm	
1000	+9	-10 dBm		1500	+9	-10 dBm	
1000	-1	-20 dBm		1500	-1	-20 dBm	
1000	-11	-20 dBm		1500	-11	-20 dBm	
1000	-20	-20 dBm		1500	-20	-20 dBm	
1000	-30	-20 dBm		1500	-30	-20 dBm	
1000	-40	-20 dBm		1500	-40	-20 dBm	
1000	-51	-70 dBm		1500	-51	-70 dBm	

2000 MHz to 5200 MHz							
Freq (MHz)	SMB100A Output Level	Ranger Input Level	✓	Freq (MHz)	SMB100A Output Level	Ranger Input Level	✓
2000	+19	0 dBm		2500	+19	0 dBm	
2000	+9	-10 dBm		2500	+9	-10 dBm	
2000	-1	-20 dBm		2500	-1	-20 dBm	
2000	-11	-20 dBm		2500	-11	-20 dBm	
2000	-20	-20 dBm		2500	-20	-20 dBm	
2000	-30	-20 dBm		2500	-30	-20 dBm	
2000	-40	-20 dBm		2500	-40	-20 dBm	
2000	-51	-70 dBm		2500	-51	-70 dBm	
3000 MHz to 3500 MHz							
Freq (MHz)	SMB100A Output Level	Ranger Input Level	✓	Freq (MHz)	SMB100A Output Level	Ranger Input Level	✓
3000	+19	0 dBm		3500	+19	0 dBm	
3000	+9	-10 dBm		3500	+9	-10 dBm	
3000	-1	-20 dBm		3500	-1	-20 dBm	
3000	-11	-20 dBm		3500	-11	-20 dBm	
3000	-20	-20 dBm		3500	-20	-20 dBm	
3000	-30	-20 dBm		3500	-30	-20 dBm	
3000	-40	-20 dBm		3500	-40	-20 dBm	
3000	-51	-70 dBm		3500	-51	-70 dBm	
4000 MHz to 4500 MHz							
Freq (MHz)	SMB100A Output Level	Ranger Input Level	✓	Freq (MHz)	SMB100A Output Level	Ranger Input Level	✓
4000	+19	0 dBm		4500	+19	0 dBm	
4000	+9	-10 dBm		4500	+9	-10 dBm	
4000	-1	-20 dBm		4500	-1	-20 dBm	
4000	-11	-20 dBm		4500	-11	-20 dBm	
4000	-20	-20 dBm		4500	-20	-20 dBm	
4000	-30	-20 dBm		4500	-30	-20 dBm	
4000	-40	-20 dBm		4500	-40	-20 dBm	
4000	-51	-70 dBm		4500	-51	-70 dBm	

5000 MHz to 5500 MHz							
Freq (MHz)	SMB100A Output Level	Ranger Input Level	✓	Freq (MHz)	SMB100A Output Level	Ranger Input Level	✓
5000	+19	0 dBm		5500	+19	0 dBm	
5000	+9	-10 dBm		5500	+9	-10 dBm	
5000	-1	-20 dBm		5500	-1	-20 dBm	
5000	-11	-20 dBm		5500	-11	-20 dBm	
5000	-20	-20 dBm		5500	-20	-20 dBm	
5000	-30	-20 dBm		5500	-30	-20 dBm	
5000	-40	-20 dBm		5500	-40	-20 dBm	
5000	-51	-70 dBm		5500	-51	-70 dBm	
6000 MHz							
Freq (MHz)	SMB100A Output Level	Ranger Input Level	✓				
6000	+19	0 dBm					
6000	+9	-10 dBm					
6000	-1	-20 dBm					
6000	-11	-20 dBm					
6000	-20	-20 dBm					
6000	-30	-20 dBm					
6000	-40	-20 dBm					
6000	-51	-70 dBm					

5.8 RF Input Analysis Bandwidth Flatness

Prerequisites: Perform Preliminary Procedure

Equipment: SMB100A RF Signal Generator

Step / Procedure

- 1) Connect the SMB100A to the Ranger RF Input Port.
- 2) Set SMB100A RF Level to 0 dBm.
- 3) Set SMB100A Modulation to CW.
- 4) Set SMB100A RF Frequencies to frequencies plus noted offsets in Table 10.

NOTE: Level flatness over frequency must be validated using a broadband power meter. Absolute power is not critical in this case.

- 5) Set Ranger RF Input to RF In.
- 6) Set Ranger Input Level to 0 dBm.
- 7) Set Ranger Signal WorkShop SVT Spectrum Settings as follows:
 - a) Peak Hold
 - b) 2 dB total vertical window size
- 8) Set Ranger Frequency to corresponding values in Table 10.
- 9) Set Bandwidth according to frequency:
 - a) 100 MHz (125M samples/sec) for 100 MHz
 - b) 200 MHz (250M samples/sec) for all other frequencies.
- 10) Use the SVT Peak Marker function to verify the relative flatness value in the test data sheet.
- 11) Repeat steps 8 through 10 for each frequency and offset combination in Table 10.

Table 10 RF Input Analysis Bandwidth Flatness Frequencies

100 MHz Frequency					
Freq (MHz)	SMB100A Offset (MHz)	✓	Freq (MHz)	SMB100A Offset (MHz)	✓
			100	+1	
100	-2		100	+2	
100	-3		100	+3	
100	-4		100	+4	
100	-5		100	+5	
100	-6		100	+6	
100	-7		100	+7	
100	-8		100	+8	
100	-9		100	+9	
100	-10		100	+10	
100	-12		100	+12	

100	-14		100	+14	
100	-16		100	+16	
100	-18		100	+18	
100	-20		100	+20	
300 MHz					
Freq (MHz)	SMB100A Offset (MHz)	✓	Freq (MHz)	SMB100A Offset (MHz)	✓
			300	+1	
300	-2		300	+2	
300	-3		300	+3	
300	-4		300	+4	
300	-5		300	+5	
300	-6		300	+6	
300	-7		300	+7	
300	-8		300	+8	
300	-9		300	+9	
300	-10		300	+10	
300	-15		300	+15	
300	-20		300	+20	
300	-25		300	+25	
300	-30		300	+30	
300	-35		300	+35	
300	-40		300	+40	
300	-45		300	+45	
300	-50		300	+50	
300	-55		300	+55	
300	-60		300	+60	
300	-65		300	+65	
300	-70		300	+70	
300	-75		300	+75	
300	-80		300	+80	

3000 MHz Band					
Freq (MHz)	SMB100A Offset (MHz)	✓	Freq (MHz)	SMB100A Offset (MHz)	✓
			3000	+1	
3000	-2		3000	+2	
3000	-3		3000	+3	
3000	-4		3000	+4	
3000	-5		3000	+5	
3000	-6		3000	+6	
3000	-7		3000	+7	
3000	-8		3000	+8	
3000	-9		3000	+9	
3000	-10		3000	+10	
3000	-15		3000	+15	
3000	-20		3000	+20	
3000	-25		3000	+25	
3000	-30		3000	+30	
3000	-35		3000	+35	
3000	-40		3000	+40	
3000	-45		3000	+45	
3000	-50		3000	+50	
3000	-55		3000	+55	
3000	-60		3000	+60	
3000	-65		3000	+65	
3000	-70		3000	+70	
3000	-75		3000	+75	
3000	-80		3000	+80	

VERIFICATION/ACCEPTANCE DATA SHEET

Technician: _____ Date: _____
 Ranger System Number: _____ Ranger Serial Number: _____

Test Procedure 5.1.1 RF Output and OCXO Frequency Accuracy Measurements

Frequency (MHz)	Lo Limit (Hz)	Measurement (MHz)	Hi Limit (Hz)	Status (P/F)
1.0	999994.0		1000006.0	
200	199999994.0		200000006.0	
1000	999999994.0		1000000006.0	
3000	2999999994.0		3000000006.0	
3299	3298999994.0		3299000006.0	
5699	5698999994.0		5699000006.0	
6000	5999999994.0		6000000006.0	
6000 (OCXO)	5999999400.0		6000000600.0	

Test Procedure 5.1.2 RF Input Frequency Accuracy Measurements

Frequency (MHz)	Lo Limit (Hz)	Measurement (MHz)	Hi Limit (Hz)	Status (P/F)
50	49,999,994.0		50000006.0	
200	199999994.0		200000006.0	
1000	999999994.0		1000000006.0	
3000	2999999994.0		3000000006.0	
3299	3298999994.0		3299000006.0	
5699	5698999994.0		5699000006.0	
6000	5999999994.0		6000000006.0	

Test Procedure 5.2 RF Output Amplitude Accuracy Measurements

Freq (MHz)	Setting (dBm)	Min (dBm)	Reading (dBm)	Max (dBm)	Status (p/f)
49	+9	8.6		9.4	
49	-1	-1.4		-0.6	
49	-11	-11.4		-10.6	
49	-21	-21.6		-20.4	
49	-31	-31.6		-30.4	
49	-41	-41.6		-40.4	
49	-51	-51.6		-50.4	
49	-61	-61.6		-60.4	
49	-71	-71.6		-70.4	

Freq (MHz)	Setting (dBm)	Min (dBm)	Reading (dBm)	Max (dBm)	Status (p/f)
49	-81	-81.7		-80.3	
49	-91	-91.7		-90.3	
49	-101	-101.7		-100.3	
49	-110	-110.7		-109.3	
100	+7	6.6		7.4	
100	-3	-3.4		-2.6	
100	-13	-13.4		-12.6	
100	-23	-23.6		-22.4	
100	-33	-33.6		-32.4	
100	-43	-43.6		-42.4	
100	-53	-53.6		-52.4	
100	-63	-63.6		-62.4	
100	-73	-73.6		-72.4	
100	-83	-83.7		-82.3	
100	-93	-93.7		-92.3	
100	-103	-103.7		-102.3	
100	-110	-110.7		-109.3	
512	+9	8.5		9.5	
512	-1	-1.5		-0.5	
512	-11	-11.5		-10.5	
512	-21	-21.7		-20.3	
512	-31	-31.7		-30.3	
512	-41	-41.7		-40.3	
512	-51	-51.7		-50.3	
512	-61	-61.7		-60.3	
512	-71	-71.7		-70.3	
512	-81	-81.9		-80.1	
512	-91	-91.9		-90.1	
512	-101	-101.9		-100.1	
512	-110	-110.9		-109.1	
1101	+2	1.5		2.5	
1101	-8	-8.5		-7.5	
1101	-18	-18.5		-17.5	
1101	-28	-28.7		-27.3	
1101	-38	-38.7		-37.3	
1101	-48	-48.7		-47.3	
1101	-58	-58.7		-57.3	
1101	-68	-68.7		-67.3	

Freq (MHz)	Setting (dBm)	Min (dBm)	Reading (dBm)	Max (dBm)	Status (p/f)
1101	-78	-78.7		-77.3	
1101	-88	-88.9		-87.1	
1101	-98	-98.9		-97.1	
1101	-108	-108.9		-107.1	
1101	-115	-115.9		-114.1	
1501	+9	8.5		9.5	
1501	-1	-1.5		-0.5	
1501	-11	-11.5		-10.5	
1501	-21	-21.7		-20.3	
1501	-31	-31.7		-30.3	
1501	-41	-41.7		-40.3	
1501	-51	-51.7		-50.3	
1501	-61	-61.7		-60.3	
1501	-71	-74.7		-70.3	
1501	-81	-81.9		-80.1	
1501	-91	-91.9		-90.1	
1501	-101	-101.9		-100.1	
1501	-110	-110.9		-109.1	
2501	+3	2.5		3.5	
2501	-7	-7.5		-6.5	
2501	-17	-17.5		-16.5	
2501	-27	-27.7		-26.3	
2501	-37	-37.7		-36.3	
2501	-47	-47.7		-46.3	
2501	-57	-57.7		-56.3	
2501	-64	-67.7		-66.3	
2501	-74	-77.7		-76.3	
2501	-87	-87.9		-86.1	
2501	-97	-97.9		-96.1	
2501	-107	-107.9		-106.1	
2501	-110	-110.9		-109.1	
3501	+10	9.3		10.7	
3501	0	-0.7		0.7	
3501	-10	-10.7		-9.3	
3501	-20	-20.7		-19.3	
3501	-30	-30.7		-29.3	
3501	-40	-40.7		-39.3	
3501	-50	-50.7		-49.3	

Freq (MHz)	Setting (dBm)	Min (dBm)	Reading (dBm)	Max (dBm)	Status (p/f)
3501	-60	-60.7		-59.3	
3501	-70	-70.7		-69.3	
3501	-80	-81.6		-78.4	
3501	-90	-91.6		-88.4	
3501	-100	-101.6		-98.4	
3501	-110	-111.6		-108.4	
4501	+9	8.3		9.7	
4501	-1	-1.7		-0.3	
4501	-11	-11.7		-10.3	
4501	-21	-21.7		-20.3	
4501	-31	-31.7		-30.3	
4501	-41	-41.7		-40.3	
4501	-51	-51.7		-50.3	
4501	-61	-61.7		-60.3	
4501	-71	-71.7		-70.3	
4501	-81	-82.6		-79.4	
4501	-91	-92.6		-89.4	
4501	-101	-102.6		-99.4	
4501	-110	-111.6		-108.4	
5501	+8	7.3		8.7	
5501	-2	-2.7		-1.3	
5501	-12	-12.7		-11.3	
5501	-22	-22.7		-21.3	
5501	-32	-32.7		-31.3	
5501	-42	-42.7		-41.3	
5501	-52	-52.7		-51.3	
5501	-62	-62.7		-61.3	
5501	-72	-72.7		-71.3	
5501	-82	-83.6		-80.4	
5501	-92	-93.6		-90.4	
5501	-102	-103.6		-100.4	
5501	-110	-111.6		-108.4	
6000	+2	1.3		2.7	
6000	-8	-8.7		-7.3	
6000	-18	-18.7		-17.3	
6000	-28	-28.7		-27.3	
6000	-38	-38.7		-37.3	
6000	-48	-48.7		-47.3	

Freq (MHz)	Setting (dBm)	Min (dBm)	Reading (dBm)	Max (dBm)	Status (p/f)
6000	-58	-58.7		-57.3	
6000	-68	-68.7		-67.3	
6000	-78	-78.7		-77.3	
6000	-88	-89.6		-86.4	
6000	-98	-99.6		-96.4	
6000	-108	-109.6		-106.4	
6000	-118	-119.6		-116.4	

Test Procedure 5.3 Duplex Output Amplitude Accuracy Measurements

Freq (MHz)	Setting (dBm)	Min (dBm)	Reading (dBm)	Max (dBm)	Status (p/f)
49	-35	-35.4		-34.6	
49	-45	-45.4		-44.6	
49	-55	-55.6		-54.4	
49	-65	-65.6		-64.4	
49	-75	-75.6		-74.4	
49	-85	-85.6		-84.4	
49	-95	-95.6		-94.4	
49	-105	-105.6		-104.4	
49	-115	-115.6		-114.4	
49	-120	-120.6		-119.4	
100	-30	-30.4		-29.6	
100	-40	-40.4		-39.6	
100	-50	-50.6		-49.4	
100	-60	-60.6		-59.4	
100	-70	-70.6		-69.4	
100	-80	-80.4		-79.6	
100	-90	-90.6		-89.4	
100	-100	-100.6		-99.4	
100	-110	-110.6		-109.4	
100	-120	-120.6		-119.4	
512	-35	-35.5		-34.5	
512	-45	-45.5		-44.5	
512	-55	-55.7		-54.3	
512	-65	-65.7		-64.3	
512	-75	-75.7		-74.3	
512	-85	-85.7		-84.3	
512	-95	-95.7		-94.3	
512	-105	-105.7		-104.3	

Freq (MHz)	Setting (dBm)	Min (dBm)	Reading (dBm)	Max (dBm)	Status (p/f)
512	-115	-115.7		-114.3	
512	-120	-120.7		-119.3	
1101	-30	-30.5		-29.5	
1101	-40	-40.5		-39.5	
1101	-50	-50.8		-49.2	
1101	-60	-60.8		-59.2	
1101	-70	-70.8		-69.2	
1101	-80	-80.8		-79.2	
1101	-90	-90.8		-89.2	
1101	-100	-100.8		-99.2	
1101	-110	-110.8		-109.2	
1101	-120	-120.8		-119.2	
1501	-35	-35.5		-34.5	
1501	-45	-45.5		-44.5	
1501	-55	-55.8		-54.2	
1501	-65	-65.8		-64.2	
1501	-75	-75.8		-74.2	
1501	-85	-85.8		-84.2	
1501	-95	-95.8		-94.2	
1501	-105	-105.8		-104.2	
1501	-115	-115.8		-114.2	
1501	-120	-120.8		-119.2	
2501	-30	-30.5		-29.5	
2501	-40	-40.5		-39.5	
2501	-50	-50.8		-49.2	
2501	-60	-60.8		-59.2	
2501	-70	-70.8		-69.2	
2501	-80	-80.8		-79.2	
2501	-90	-90.8		-89.2	
2501	-100	-100.8		-99.2	
2501	-110	-110.8		-109.2	
2501	-120	-120.8		-119.2	
3501	-35	-35.5		-34.5	
3501	-45	-45.5		-44.5	
3501	-55	-55.8		-54.2	
3501	-65	-65.8		-64.2	
3501	-75	-75.8		-74.2	
3501	-85	-85.8		-84.2	

Freq (MHz)	Setting (dBm)	Min (dBm)	Reading (dBm)	Max (dBm)	Status (p/f)
3501	-95	-95.8		-94.2	
3501	-105	-105.8		-104.2	
3501	-115	-115.8		-114.2	
3501	-120	-120.8		-119.2	
4501	-30	-30.7		-29.3	
4501	-40	-40.7		-39.3	
4501	-50	-51.0		-49.0	
4501	-60	-61.0		-59.0	
4501	-70	-71.0		-69.0	
4501	-80	-81.0		-79.0	
4501	-90	-91.0		-89.0	
4501	-100	-101.0		-99.0	
4501	-110	-111.0		-109.0	
4501	-120	-121.0		-119.0	
5501	-35	-35.7		-34.3	
5501	-45	-45.7		-44.3	
5501	-55	-56.0		-54.0	
5501	-65	-66.0		-64.0	
5501	-75	-76.0		-74.0	
5501	-85	-86.0		-84.0	
5501	-95	-96.0		-94.0	
5501	-105	-106.0		-104.0	
5501	-115	-116.0		-114.0	
5501	-120	-121.0		-119.0	
6000	-30	-30.7		-29.3	
6000	-40	-40.7		-39.3	
6000	-50	-51.0		-49.0	
6000	-60	-61.0		-59.0	
6000	-70	-71.0		-69.0	
6000	-80	-81.0		-79.0	
6000	-90	-91.0		-89.0	
6000	-100	-101.0		-99.0	
6000	-110	-111.0		-109.0	
6000	-120	-121.0		-119.0	

Test Procedure 5.4 RF Output Harmonic Spurious Measurements

Frequency (MHz)	Harmonic	Measurement	Max Limit (dBc)	Status (p/f)
200	2nd		-33.0	
200	3rd		-33.0	
200	4th		-33.0	
200	5th		-33.0	
400	2nd		-33.0	
400	3rd		-33.0	
400	4th		-33.0	
400	5th		-33.0	
600	2nd		-33.0	
600	3rd		-33.0	
600	4th		-33.0	
600	5th		-33.0	
800	2nd		-33.0	
800	3rd		-33.0	
800	4th		-33.0	
800	5th		-33.0	
1000	2nd		-33.0	
1000	3rd		-33.0	
1000	4th		-33.0	
1000	5th		-33.0	
1200	2nd		-33.0	
1200	3rd		-33.0	
1200	4th		-33.0	
1200	5th		-33.0	
1400	2nd		-33.0	
1400	3rd		-33.0	
1400	4th		-33.0	
1400	5th		-33.0	
1600	2nd		-33.0	
1600	3rd		-33.0	
1600	4th		-33.0	
1600	5th		-33.0	
1800	2nd		-33.0	
1800	3rd		-33.0	
1800	4th		-33.0	
1800	5th		-33.0	

Frequency (MHz)	Harmonic	Measurement	Max Limit (dBc)	Status (p/f)
2000	2nd		-33.0	
2000	3rd		-33.0	
2000	4th		-33.0	
2000	5th		-33.0	
2200	2nd		-33.0	
2200	3rd		-33.0	
2200	4th		-33.0	
2200	5th		-33.0	
2400	2nd		-33.0	
2400	3rd		-33.0	
2400	4th		-33.0	
2400	5th		-33.0	
2600	2nd		-33.0	
2600	3rd		-33.0	
2600	4th		-33.0	
2600	5th		-33.0	
2800	2nd		-33.0	
2800	3rd		-33.0	
2800	4th		-33.0	
2800	5th		-33.0	
3000	2nd		-33.0	
3000	3rd		-33.0	
3000	4th		-33.0	
3000	5th		-33.0	
3200	2nd		-33.0	
3200	3rd		-33.0	
3200	4th		-33.0	
3200	5th		-33.0	
3400	2nd		-33.0	
3400	3rd		-33.0	
3400	4th		-33.0	
3400	5th		-33.0	
3600	2nd		-33.0	
3600	3rd		-33.0	
3600	4th		-33.0	
3600	5th		-33.0	
3800	2nd		-33.0	

Frequency (MHz)	Harmonic	Measurement	Max Limit (dBc)	Status (p/f)
3800	3rd		-33.0	
3800	4th		-33.0	
4000	2nd		-33.0	
4000	3rd		-33.0	
4000	4th		-33.0	
4200	2nd		-33.0	
4200	3rd		-33.0	
4200	4th		-33.0	
4400	2nd		-33.0	
4400	3rd		-33.0	
4400	4th		-33.0	
4600	2nd		-33.0	
4600	3rd		-33.0	
4800	2nd		-33.0	
4800	3rd		-33.0	
5000	2nd		-33.0	
5000	3rd		-33.0	
5200	2nd		-33.0	
5200	3rd		-33.0	
5400	2nd		-33.0	
5400	3rd		-33.0	
5600	2nd		-33.0	
5600	3rd		-33.0	
5800	2nd		-33.0	
5800	3rd		-33.0	
6000	2nd		-33.0	
6000	3rd		-33.0	

Test Procedure 5.5 RF Output Single Sideband (SSB) Phase Noise Measurements

Test Frequency (MHz)	Offset	Measurement	Max Limit (dBc/Hz)	Status (p/f)
900	1 MHz		-129.0	
900	10 kHz		-114.0	
900	1 kHz		-107.0	
1900	1 MHz		-128.0	
1900	10 kHz		-108.0	
1900	1 kHz		-101.0	

2900	1 MHz		-126.0	
2900	10 kHz		-104.0	
2900	1 kHz		-98.0	
5900	1 MHz		-123.0	
5900	10 kHz		-98.0	
5900	1 kHz		-90.0	

Test Procedure 5.6 RF Input Amplitude Accuracy Measurements

Test Frequency (MHz)	Output Level (dBm)	Lo Limit (dBm)	Measurement (dBm)	Hi Limit (dBm)	Status (p/f)
1	+9	8.3		9.7	
1	+7	6.3		7.7	
1	+5	4.3		5.7	
1	+3	2.3		3.7	
1	+1	0.3		1.7	
1	-1	-1.7		-0.3	
1	-3	-3.7		-2.3	
1	-5	-5.7		-4.3	
1	-7	-7.7		-6.3	
1	-9	-9.7		-8.3	
1	-11	-11.7		-10.3	
1	-20	-20.7		-19.3	
1	-30	-30.7		-29.3	
1	-40	-40.7		-39.3	
1	-51	-52.2		-49.8	
1	-60	-61.2		-58.8	
1	-70	-71.2		-68.8	
1	-80	-81.2		-78.8	
75	+9	8.6		9.4	
75	+7	6.6		7.4	
75	+5	4.6		5.4	
75	+3	2.6		3.4	
75	+1	0.6		1.4	
75	-1	-1.4		-0.6	
75	-3	-3.4		-2.6	
75	-5	-5.4		-4.6	
75	-7	-7.4		-6.6	
75	-9	-9.4		-8.6	
75	-11	-11.4		-10.6	

Test Frequency (MHz)	Output Level (dBm)	Lo Limit (dBm)	Measurement (dBm)	Hi Limit (dBm)	Status (p/f)
75	-20	-20.4		-19.6	
75	-30	-30.4		-29.6	
75	-40	-40.4		-39.6	
75	-51	-51.7		-50.3	
75	-60	-60.7		-59.3	
75	-70	-70.8		-69.2	
75	-80	-80.8		-79.2	
100	+9	8.6		9.4	
100	+7	6.6		7.4	
100	+5	4.6		5.4	
100	+3	2.6		3.4	
100	+1	0.6		1.4	
100	-1	-1.4		-0.6	
100	-3	-3.4		-2.6	
100	-5	-5.4		-4.6	
100	-7	-7.4		-6.6	
100	-9	-9.4		-8.6	
100	-11	-11.4		-10.6	
100	-20	-20.4		-19.6	
100	-30	-30.4		-29.6	
100	-40	-40.4		-39.6	
100	-51	-51.7		-50.3	
100	-60	-60.7		-59.3	
100	-70	-70.8		-69.2	
100	-80	-80.8		-79.2	
500	+9	8.6		9.4	
500	+7	6.6		7.4	
500	+5	4.6		5.4	
500	+3	2.6		3.4	
500	+1	0.6		1.4	
500	-1	-1.4		-0.6	
500	-3	-3.4		-2.6	
500	-5	-5.4		-4.6	
500	-7	-7.4		-6.6	
500	-9	-9.4		-8.6	
500	-11	-11.4		-10.6	
500	-20	-20.4		-19.6	

Test Frequency (MHz)	Output Level (dBm)	Lo Limit (dBm)	Measurement (dBm)	Hi Limit (dBm)	Status (p/f)
500	-30	-30.4		-29.6	
500	-40	-40.4		-39.6	
500	-51	-51.7		-50.3	
500	-60	-60.7		-59.3	
500	-70	-70.8		-69.2	
500	-80	-80.8		-79.2	
700	+9	8.5		9.5	
700	+7	6.5		7.5	
700	+5	4.5		5.5	
700	+3	2.5		3.5	
700	+1	0.5		1.5	
700	-1	-1.5		-0.5	
700	-3	-3.5		-2.5	
700	-5	-5.5		-4.5	
700	-7	-7.5		-6.5	
700	-9	-9.5		-8.5	
700	-11	-11.5		-10.5	
700	-20	-20.5		-19.5	
700	-30	-30.5		-29.5	
700	-40	-40.5		-39.5	
700	-51	-51.8		-50.2	
700	-60	-60.8		-59.2	
700	-70	-70.9		-69.1	
700	-80	-80.9		-79.1	
900	+9	8.5		9.5	
900	+7	6.5		7.5	
900	+5	4.5		5.5	
900	+3	2.5		3.5	
900	+1	0.5		1.5	
900	-1	-1.5		-0.5	
900	-3	-3.5		-2.5	
900	-5	-5.5		-4.5	
900	-7	-7.5		-6.5	
900	-9	-9.5		-8.5	
900	-11	-11.5		-10.5	
900	-20	-20.5		-19.5	
900	-30	-30.5		-29.5	

Test Frequency (MHz)	Output Level (dBm)	Lo Limit (dBm)	Measurement (dBm)	Hi Limit (dBm)	Status (p/f)
900	-40	-40.5		-39.5	
900	-51	-51.8		-50.2	
900	-60	-60.8		-59.2	
900	-70	-70.9		-69.1	
900	-80	-80.9		-79.1	
1000	+9	8.5		9.5	
1000	+7	6.5		7.5	
1000	+5	4.5		5.5	
1000	+3	2.5		3.5	
1000	+1	0.5		1.5	
1000	-1	-1.5		-0.5	
1000	-3	-3.5		-2.5	
1000	-5	-5.5		-4.5	
1000	-7	-7.5		-6.5	
1000	-9	-9.5		-8.5	
1000	-11	-11.5		-10.5	
1000	-20	-20.5		-19.5	
1000	-30	-30.5		-29.5	
1000	-40	-40.5		-39.5	
1000	-51	-51.8		-50.2	
1000	-60	-60.8		-59.2	
1000	-70	-70.9		-69.1	
1000	-80	-80.9		-79.1	
1500	+9	8.4		9.6	
1500	+7	6.4		7.6	
1500	+5	4.4		5.6	
1500	+3	2.4		3.6	
1500	+1	0.4		1.6	
1500	-1	-1.6		-0.4	
1500	-3	-3.6		-2.4	
1500	-5	-5.6		-4.4	
1500	-7	-7.6		-6.4	
1500	-9	-9.6		-8.4	
1500	-11	-11.6		-10.4	
1500	-20	-20.6		-19.4	
1500	-30	-30.6		-29.4	
1500	-40	-40.6		-39.4	

Test Frequency (MHz)	Output Level (dBm)	Lo Limit (dBm)	Measurement (dBm)	Hi Limit (dBm)	Status (p/f)
1500	-51	-51.9		-50.1	
1500	-60	-60.9		-59.1	
1500	-70	-71		-69	
1500	-80	-81		-79	
2000	+9	8.4		9.6	
2000	+7	6.4		7.6	
2000	+5	4.4		5.6	
2000	+3	2.4		3.6	
2000	+1	0.4		1.6	
2000	-1	-1.6		-0.4	
2000	-3	-3.6		-2.4	
2000	-5	-5.6		-4.4	
2000	-7	-7.6		-6.4	
2000	-9	-9.6		-8.4	
2000	-11	-11.6		-10.4	
2000	-20	-20.6		-19.4	
2000	-30	-30.6		-29.4	
2000	-40	-40.6		-39.4	
2000	-51	-51.9		-50.1	
2000	-60	-60.9		-59.1	
2000	-70	-71		-69	
2000	-80	-81		-79	
2500	+9	8.4		9.6	
2500	+7	6.4		7.6	
2500	+5	4.4		5.6	
2500	+3	2.4		3.6	
2500	+1	0.4		1.6	
2500	-1	-1.6		-0.4	
2500	-3	-3.6		-2.4	
2500	-5	-5.6		-4.4	
2500	-7	-7.6		-6.4	
2500	-9	-9.6		-8.4	
2500	-11	-11.6		-10.4	
2500	-20	-20.6		-19.4	
2500	-30	-30.6		-29.4	
2500	-40	-40.6		-39.4	
2500	-51	-51.9		-50.1	

Test Frequency (MHz)	Output Level (dBm)	Lo Limit (dBm)	Measurement (dBm)	Hi Limit (dBm)	Status (p/f)
2500	-60	-60.9		-59.1	
2500	-70	-71		-69	
2500	-80	-81		-79	
3000	+9	8.3		9.7	
3000	+7	6.3		7.7	
3000	+5	4.3		5.7	
3000	+3	2.3		3.7	
3000	+1	0.3		1.7	
3000	-1	-1.7		-0.3	
3000	-3	-3.7		-2.3	
3000	-5	-5.7		-4.3	
3000	-7	-7.7		-6.3	
3000	-9	-9.7		-8.3	
3000	-11	-11.7		-10.3	
3000	-20	-20.7		-19.3	
3000	-30	-30.7		-29.3	
3000	-40	-40.7		-39.3	
3000	-51	-52.0		-50	
3000	-60	-61.0		-60	
3000	-70	-71.1		-68.9	
3000	-80	-81.1		-78.9	
3500	+9	8.3		9.7	
3500	+7	6.3		7.7	
3500	+5	4.3		5.7	
3500	+3	2.3		3.7	
3500	+1	0.3		1.7	
3500	-1	-1.7		-0.3	
3500	-3	-3.7		-2.3	
3500	-5	-5.7		-4.3	
3500	-7	-7.7		-6.3	
3500	-9	-9.7		-8.3	
3500	-11	-11.7		-10.3	
3500	-20	-20.7		-19.3	
3500	-30	-30.7		-29.3	
3500	-40	-40.7		-39.3	
3500	-51	-52.0		-50	
3500	-60	-61.0		-60	

Test Frequency (MHz)	Output Level (dBm)	Lo Limit (dBm)	Measurement (dBm)	Hi Limit (dBm)	Status (p/f)
3500	-70	-71.1		-68.9	
3500	-80	-81.1		-78.9	
4000	+9	8.3		9.7	
4000	+7	6.3		7.7	
4000	+5	4.3		5.7	
4000	+3	2.3		3.7	
4000	+1	0.3		1.7	
4000	-1	-1.7		-0.3	
4000	-3	-3.7		-2.3	
4000	-5	-5.7		-4.3	
4000	-7	-7.7		-6.3	
4000	-9	-9.7		-8.3	
4000	-11	-11.7		-10.3	
4000	-20	-20.7		-19.3	
4000	-30	-30.7		-29.3	
4000	-40	-40.7		-39.3	
4000	-51	-52.0		-50	
4000	-60	-61.0		-60	
4000	-70	-71.1		-68.9	
4000	-80	-81.1		-78.9	
4500	+9	8.3		9.7	
4500	+7	6.3		7.7	
4500	+5	4.3		5.7	
4500	+3	2.3		3.7	
4500	+1	0.3		1.7	
4500	-1	-1.7		-0.3	
4500	-3	-3.7		-2.3	
4500	-5	-5.7		-4.3	
4500	-7	-7.7		-6.3	
4500	-9	-9.7		-8.3	
4500	-11	-11.7		-10.3	
4500	-20	-20.7		-19.3	
4500	-30	-30.7		-29.3	
4500	-40	-40.7		-39.3	
4500	-51	-52.0		-50	
4500	-60	-61.0		-60	
4500	-70	-71.1		-68.9	

Test Frequency (MHz)	Output Level (dBm)	Lo Limit (dBm)	Measurement (dBm)	Hi Limit (dBm)	Status (p/f)
4500	-80	-81.1		-78.9	
5000	+9	8.3		9.7	
5000	+7	6.3		7.7	
5000	+5	4.3		5.7	
5000	+3	2.3		3.7	
5000	+1	0.3		1.7	
5000	-1	-1.7		-0.3	
5000	-3	-3.7		-2.3	
5000	-5	-5.7		-4.3	
5000	-7	-7.7		-6.3	
5000	-9	-9.7		-8.3	
5000	-11	-11.7		-10.3	
5000	-20	-20.7		-19.3	
5000	-30	-30.7		-29.3	
5000	-40	-40.7		-39.3	
5000	-51	-52.0		-50	
5000	-60	-61.0		-60	
5000	-70	-71.1		-68.9	
5000	-80	-81.1		-78.9	
5500	+9	8.3		9.7	
5500	+7	6.3		7.7	
5500	+5	4.3		5.7	
5500	+3	2.3		3.7	
5500	+1	0.3		1.7	
5500	-1	-1.7		-0.3	
5500	-3	-3.7		-2.3	
5500	-5	-5.7		-4.3	
5500	-7	-7.7		-6.3	
5500	-9	-9.7		-8.3	
5500	-11	-11.7		-10.3	
5500	-20	-20.7		-19.3	
5500	-30	-30.7		-29.3	
5500	-40	-40.7		-39.3	
5500	-51	-52.0		-50	
5500	-60	-61.0		-60	
5500	-70	-71.1		-68.9	
5500	-80	-81.1		-78.9	

Test Frequency (MHz)	Output Level (dBm)	Lo Limit (dBm)	Measurement (dBm)	Hi Limit (dBm)	Status (p/f)
6000	+9	8.3		9.7	
6000	+7	6.3		7.7	
6000	+5	4.3		5.7	
6000	+3	2.3		3.7	
6000	+1	0.3		1.7	
6000	-1	-1.7		-0.3	
6000	-3	-3.7		-2.3	
6000	-5	-5.7		-4.3	
6000	-7	-7.7		-6.3	
6000	-9	-9.7		-8.3	
6000	-11	-11.7		-10.3	
6000	-20	-20.7		-19.3	
6000	-30	-30.7		-29.3	
6000	-40	-40.7		-39.3	
6000	-51	-52.0		-50	
6000	-60	-61.0		-60	
6000	-70	-71.1		-68.9	
6000	-80	-81.1		-78.9	

Test Procedure 5.7 Duplex Input Amplitude Accuracy Measurements

Test Frequency (MHz)	Test Level (dBm)	Lo Limit (dBm)	Measurement (dBm)	Hi Limit (dBm)	Status (p/f)
1	+19	18.3		19.7	
1	+9	8.3		9.7	
1	-1	-1.7		-0.3	
1	-11	-11.7		-10.3	
1	-20	-20.7		-19.3	
1	-30	-30.7		-29.3	
1	-40	-40.7		-39.3	
1	-51	-52.2		-49.8	
75	+19	18.6		19.4	
75	+9	8.6		9.4	
75	-1	-1.4		-0.6	
75	-11	-11.4		-10.6	
75	-20	-20.4		-19.6	
75	-30	-30.4		-29.6	
75	-40	-40.4		-39.6	

Test Frequency (MHz)	Test Level (dBm)	Lo Limit (dBm)	Measurement (dBm)	Hi Limit (dBm)	Status (p/f)
75	-51	-51.7		-50.3	
100	+19	18.6		19.4	
100	+9	8.6		9.4	
100	-1	-1.4		-0.6	
100	-11	-11.4		-10.6	
100	-20	-20.4		-19.6	
100	-30	-30.4		-29.6	
100	-40	-40.4		-39.6	
100	-51	-51.7		-50.3	
500	+19	18.6		19.4	
500	+9	8.6		9.4	
500	-1	-1.4		-0.6	
500	-11	-11.4		-10.6	
500	-20	-20.4		-19.6	
500	-30	-30.4		-29.6	
500	-40	-40.4		-39.6	
500	-51	-51.7		-50.3	
700	+19	18.5		19.5	
700	+9	8.5		9.5	
700	-1	-1.5		-0.5	
700	-11	-11.5		-10.5	
700	-20	-20.5		-19.5	
700	-30	-30.2		-29.5	
700	-40	-40.2		-39.5	
700	-51	-51.8		-50.2	
900	+19	18.5		19.5	
900	+9	8.5		9.5	
900	-1	-1.5		-0.5	
900	-11	-11.5		-10.5	
900	-20	-20.5		-19.5	
900	-30	-30.2		-29.5	
900	-40	-40.2		-39.5	
900	-51	-51.8		-50.2	
1000	+19	18.5		19.5	
1000	+9	8.5		9.5	
1000	-1	-1.5		-0.5	
1000	-11	-11.5		-10.5	

Test Frequency (MHz)	Test Level (dBm)	Lo Limit (dBm)	Measurement (dBm)	Hi Limit (dBm)	Status (p/f)
1000	-20	-20.5		-19.5	
1000	-30	-30.2		-29.5	
1000	-40	-40.2		-39.5	
1000	-51	-51.8		-50.2	
1500	+19	18.4		19.6	
1500	+9	8.4		9.6	
1500	-1	-1.6		-0.4	
1500	-11	-11.6		-10.4	
1500	-20	-20.6		-19.4	
1500	-30	-30.6		-29.4	
1500	-40	-40.6		-39.4	
1500	-51	-51.9		-50.1	
2000	+19	18.4		19.6	
2000	+9	8.4		9.6	
2000	-1	-1.6		-0.4	
2000	-11	-11.6		-10.4	
2000	-20	-20.6		-19.4	
2000	-30	-30.6		-29.4	
2000	-40	-40.6		-39.4	
2000	-51	-51.9		-50.1	
2500	+19	18.4		19.6	
2500	+9	8.4		9.6	
2500	-1	-1.6		-0.4	
2500	-11	-11.6		-10.4	
2500	-20	-20.6		-19.4	
2500	-30	-30.6		-29.4	
2500	-40	-40.6		-39.4	
2500	-51	-51.9		-50.1	
3000	+19	18.4		19.6	
3000	+9	8.4		9.6	
3000	-1	-1.6		-0.4	
3000	-11	-11.6		-10.4	
3000	-20	-20.6		-19.4	
3000	-30	-30.6		-29.4	
3000	-40	-40.6		-39.4	
3000	-51	-51.9		-50.1	
3500	+19	18.3		19.7	

Test Frequency (MHz)	Test Level (dBm)	Lo Limit (dBm)	Measurement (dBm)	Hi Limit (dBm)	Status (p/f)
3500	+9	8.3		9.7	
3500	-1	-1.7		-0.3	
3500	-11	-11.7		-10.3	
3500	-20	-20.7		-19.3	
3500	-30	-30.7		-29.3	
3500	-40	-40.7		-39.3	
3500	-51	-52.0		-50	
4000	+19	18.3		19.7	
4000	+9	8.3		9.7	
4000	-1	-1.7		-0.3	
4000	-11	-11.7		-10.3	
4000	-20	-20.7		-19.3	
4000	-30	-30.7		-29.3	
4000	-40	-40.7		-39.3	
4000	-51	-52.0		-50	
4500	+19	18.3		19.7	
4500	+9	8.3		9.7	
4500	-1	-1.7		-0.3	
4500	-11	-11.7		-10.3	
4500	-20	-20.7		-19.3	
4500	-30	-30.7		-29.3	
4500	-40	-40.7		-39.3	
4500	-51	-52.0		-50	
5000	+19	18.3		19.7	
5000	+9	8.3		9.7	
5000	-1	-1.7		-0.3	
5000	-11	-11.7		-10.3	
5000	-20	-20.7		-19.3	
5000	-30	-30.7		-29.3	
5000	-40	-40.7		-39.3	
5000	-51	-52.0		-50	
5500	+19	18.3		19.7	
5500	+9	8.3		9.7	
5500	-1	-1.7		-0.3	
5500	-11	-11.7		-10.3	
5500	-20	-20.7		-19.3	
5500	-30	-30.7		-29.3	

Test Frequency (MHz)	Test Level (dBm)	Lo Limit (dBm)	Measurement (dBm)	Hi Limit (dBm)	Status (p/f)
5500	-40	-40.7		-39.3	
5500	-51	-52.0		-50	
6000	+19	18.3		19.7	
6000	+9	8.3		9.7	
6000	-1	-1.7		-0.3	
6000	-11	-11.7		-10.3	
6000	-20	-20.7		-19.3	
6000	-30	-30.7		-29.3	
6000	-40	-40.7		-39.3	
6000	-51	-52.0		-50	

Test Procedure 5.8 RF Input Analysis Bandwidth Flatness Measurements

Frequency (MHz)	Offset (MHz)	Min Error (dB)	Reading (dB)	Max Error (dB)	Status (p/f)
100	-2	-0.1		0.1	
100	-3	-0.1		0.1	
100	-4	-0.1		0.1	
100	-5	-0.1		0.1	
100	-6	-0.1		0.1	
100	-7	-0.1		0.1	
100	-8	-0.1		0.1	
100	-9	-0.1		0.1	
100	-10	-0.1		0.1	
100	-12	-0.2		0.2	
100	-14	-0.2		0.2	
100	-16	-0.2		0.2	
100	-18	-0.2		0.2	
100	-20	-0.2		0.2	
100	+1	-0.1		0.1	
100	+2	-0.1		0.1	
100	+3	-0.1		0.1	
100	+4	-0.1		0.1	
100	+5	-0.1		0.1	
100	+6	-0.1		0.1	
100	+7	-0.1		0.1	
100	+8	-0.1		0.1	
100	+9	-0.1		0.1	

Frequency (MHz)	Offset (MHz)	Min Error (dB)	Reading (dB)	Max Error (dB)	Status (p/f)
100	+10	-0.1		0.1	
100	+12	-0.2		0.2	
100	+14	-0.2		0.2	
100	+16	-0.2		0.2	
100	+18	-0.2		0.2	
100	+20	-0.2		0.2	
300	-2	-0.1		0.1	
300	-3	-0.1		0.1	
300	-4	-0.1		0.1	
300	-5	-0.1		0.1	
300	-6	-0.1		0.1	
300	-7	-0.1		0.1	
300	-8	-0.1		0.1	
300	-9	-0.1		0.1	
300	-10	-0.1		0.1	
300	-15	-0.2		0.2	
300	-20	-0.2		0.2	
300	-25	-0.2		0.2	
300	-30	-0.2		0.2	
300	-35	-0.2		0.2	
300	-40	-0.2		0.2	
300	-45	-0.3		0.3	
300	-50	-0.3		0.3	
300	-55	-0.3		0.3	
300	-60	-0.3		0.3	
300	-65	-0.3		0.3	
300	-70	-0.3		0.3	
300	-75	-0.3		0.3	
300	-80	-0.3		0.3	
300	+1	-0.1		0.1	
300	+2	-0.1		0.1	
300	+3	-0.1		0.1	
300	+4	-0.1		0.1	
300	+5	-0.1		0.1	
300	+6	-0.1		0.1	
300	+7	-0.1		0.1	
300	+8	-0.1		0.1	

Frequency (MHz)	Offset (MHz)	Min Error (dB)	Reading (dB)	Max Error (dB)	Status (p/f)
300	+9	-0.1		0.1	
300	+10	-0.1		0.1	
300	+15	-0.2		0.2	
300	+20	-0.2		0.2	
300	+25	-0.2		0.2	
300	+30	-0.2		0.2	
300	+35	-0.2		0.2	
300	+40	-0.2		0.2	
300	+45	-0.3		0.3	
300	+50	-0.3		0.3	
300	+55	-0.3		0.3	
300	+60	-0.3		0.3	
300	+65	-0.3		0.3	
300	+70	-0.3		0.3	
300	+75	-0.3		0.3	
300	+80	-0.3		0.3	
3000	-2	-0.1		0.1	
3000	-3	-0.1		0.1	
3000	-4	-0.1		0.1	
3000	-5	-0.1		0.1	
3000	-6	-0.1		0.1	
3000	-7	-0.1		0.1	
3000	-8	-0.1		0.1	
3000	-9	-0.1		0.1	
3000	-10	-0.1		0.1	
3000	-15	-0.2		0.2	
3000	-20	-0.2		0.2	
3000	-25	-0.2		0.2	
3000	-30	-0.2		0.2	
3000	-35	-0.2		0.2	
3000	-40	-0.2		0.2	
3000	-45	-0.3		0.3	
3000	-50	-0.3		0.3	
3000	-55	-0.3		0.3	
3000	-60	-0.3		0.3	
3000	-65	-0.3		0.3	
3000	-70	-0.3		0.3	

Frequency (MHz)	Offset (MHz)	Min Error (dB)	Reading (dB)	Max Error (dB)	Status (p/f)
3000	-75	-0.3		0.3	
3000	-80	-0.3		0.3	
3000	+1	-0.1		0.1	
3000	+2	-0.1		0.1	
3000	+3	-0.1		0.1	
3000	+4	-0.1		0.1	
3000	+5	-0.1		0.1	
3000	+6	-0.1		0.1	
3000	+7	-0.1		0.1	
3000	+8	-0.1		0.1	
3000	+9	-0.1		0.1	
3000	+10	-0.1		0.1	
3000	+15	-0.2		0.2	
3000	+20	-0.2		0.2	
3000	+25	-0.2		0.2	
3000	+30	-0.2		0.2	
3000	+35	-0.2		0.2	
3000	+40	-0.2		0.2	
3000	+45	-0.3		0.3	
3000	+50	-0.3		0.3	
3000	+55	-0.3		0.3	
3000	+60	-0.3		0.3	
3000	+65	-0.3		0.3	
3000	+70	-0.3		0.3	
3000	+75	-0.3		0.3	
3000	+80	-0.3		0.3	



Glossary

- A - C**
- ADC** — Analog to Digital Converter
 - ALC** — Automatic Level Control
 - API** — Application Programming Interface
 - CMP** — Configurable Modular Platform
 - CW** — Continuous Wave

- D - E**
- DAC** — Digital to Analog Converter
 - dB** — decibel
 - DHCP** — Dynamic Host Configuration Protocol
 - EMI** — Electromagnetic Interference
 - ESD** — Electrostatic Discharge
 - FPGA** — Field Programmable Gate Array

G - I

GB — gigabyte

GbE — Gigabit Ethernet

GHZ — gigahertz

IBW — Instantaneous Bandwidth

ICM — Instrument Carrier Module

IF — Intermediate Frequency

L - M

LO — Local Oscillator

MHz — megahertz

P - S

PCIe — Peripheral Component Interconnect Express

RA — Return Authorization

RF — Radio Frequency

SPI — Serial Peripheral Interface

SoC — System-on-Chip

T - U

UI — User Interface

VSA — Vector Signal Analyzer

VSG — Vector Signal Generator

VST — Vector Signal Transceiver



mA-6806
Vector Signal Transceiver
Operation Manual 141551
Rev. 502
October 2024
English

VIAVI Solutions

North America:	1.844.GO VIAVI / 1.844.468.4284
Latin America	+52 55 5543 6644
EMEA	+49 7121 862273
APAC	+1 512 201 6534
All Other Regions:	viavisolutions.com/contacts