



## OPERATION MANUAL

# NAV 2000R SIGNAL GENERATOR

**MANUAL NUMBER:** 06-0520-5A (Hard Copy)  
E6-0520-5A (CD-ROM)  
**REVISION:** 0  
**DATE:** 07/26/2007

**WARNING: INFORMATION SUBJECT TO EXPORT CONTROL LAWS**

*This document contains controlled technology or technical data under the jurisdiction of the Export Administration Regulations (EAR), 15 CFR 730-774. It cannot be transferred to any foreign third party without the specific prior approval of the U.S. Department of Commerce Bureau of Industry and Security (BIS). Violations of these regulations are punishable by fine, imprisonment, or both.*

This document is proprietary to Aeroflex, and is not to be reproduced or otherwise disseminated without the written consent of Aeroflex.

400 New Century Parkway – New Century, Kansas – 66031  
Telephone: (800) 237-2831 / (913) 764-2452 Fax: (913) 782-5104  
[www.aeroflex.com](http://www.aeroflex.com)



## ELECTROSTATIC DISCHARGE GENERAL WARNINGS FOR ALL EQUIPMENT

**CAUTION:** THIS EQUIPMENT MAY CONTAIN ELECTROSTATIC DISCHARGE (ESD) SENSITIVE COMPONENTS. TO PREVENT ESD SENSITIVE EQUIPMENT FROM POSSIBLE DAMAGE, OBSERVE THE FOLLOWING PRECAUTIONS WHEN HANDLING ANY ESD SENSITIVE COMPONENTS, OR UNITS CONTAINING ESD SENSITIVE COMPONENTS:

- a. Maintenance or service personnel must be grounded through a conductive wrist strap, or a similar grounding device, using a 1 M $\Omega$  series resistor for equipment protection against static discharge, and personal protection against electrical shock.
- b. All tools must be grounded (including soldering tools) that may come into contact with the equipment. Hand contact will provide sufficient grounding for tools that are not otherwise grounded, provided the operator is grounded through an acceptable grounding device such as a wrist strap.
- c. Maintenance or service of the unit must be done at a grounded, ESD workstation.
- d. Before maintenance or service of the equipment, disconnect all power sources, signal sources, and loads connected to the unit.
- e. If maintenance or service must be performed with power applied, take precautions against accidental disconnection of equipment components. Specifically, do not remove integrated circuits or printed circuit boards from equipment while the equipment has power applied.
- f. All ESD sensitive components are shipped in protective tubes or electrically conductive foam. The components should be stored using the original container/package when not being used or tested. If the original storage material is not available, use similar or equivalent protective storage material.
- g. When ESD sensitive components are removed from a unit, the components must be placed on a conductive surface, or in an electrically conductive container.
- h. When in storage or not being repaired, all printed circuit boards must be kept in electrically conductive bags, or other electrically conductive containers.
- i. Do not unnecessarily pick up, hold, or directly carry ESD sensitive devices.

Failure to comply with these precautions may cause permanent damage to ESD sensitive devices. This damage can cause devices to fail immediately, or at a later time without apparent cause.

**REVISION HISTORY BY DRAWING NUMBER**

MANUAL: NAV 2000R Signal Generator

REVISION: 0 – July 26, 2007

<b><u>DRAWING NO.</u></b>	<b><u>REV. LEVEL</u></b>	<b><u>DRAWING NO.</u></b>	<b><u>REV. LEVEL</u></b>
Safety and Regulatory	00		
Table of Contents	00		
Section I	00		
Section II	00		
Section III	00		
Section IV	00		
Section V	00		
Appendix A	00		

## Declaration of Conformity

DECLARATION OF CONFORMITY	
<b>Manufacturer's Name:</b>	JcAIR Test Systems
<b>Manufacturer's Address:</b>	400 New Century Parkway New Century, KS 66031-0009 USA
Declares that the products	
<b>Product Name:</b>	NAV2000R-50, NAV2000R-70, NAV2000R-80
<b>Model Number(s):</b>	01-0520-50, 01-0520-70, 01-0520-80
<b>Product Options:</b>	All options associated with listed models are covered.
Conform to the following product specifications and carry the CE-marking accordingly.	
Low Voltage Directive 73/23/EEC:	IEC 61010-1:1990 / EN 61010-1:1993
EMC Directive 89/336/EEC:	EN 61326:1998 IEC 61326:1997
Date: 10/31/00	 <b>Chuck Nehring, Director</b> Quality Assurance/Customer Support

# Safety and Regulatory Information

**Review this product and related documentation to familiarize yourself with safety markings and instructions before you operate this equipment.**

**WARNING** The **WARNING** notice denotes a hazard. It calls attention to a procedure, practice, or the like, that, if not correctly performed or adhered to, could result in personal injury. Do not proceed beyond a **WARNING** notice until the indicated conditions are fully understood and met.

**CAUTION** The **CAUTION** notice denotes a hazard. It calls attention to an operating procedure, practice, or the like, which, if not correctly performed or adhered to, could result in damage to the product or loss of important data. Do not proceed beyond a **CAUTION** notice until the indicated conditions are fully understood and met.



**Caution (refer to accompanying documents).** Attention – refer to the manual. This symbol indicates that information about usage of a feature is contained in the manual.

## Equipment Markings

The following markings may appear on this equipment:



**Direct current.** This symbol indicates that the equipment requires direct current input.

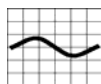

**Alternating current.** This symbol indicates that the equipment requires alternating current input.

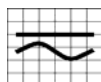

**Both direct and alternating current.** This symbol indicates that the equipment requires either ac or dc input at the same connector.

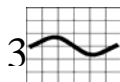

**Three-phase alternating current.** This symbol indicates that the equipment requires 3-phase ac input.

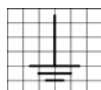

**Earth (ground) terminal.** This symbol indicates the ground (earth) terminal.



**Protective conductor terminal.** This symbol indicates the protective ground (earth) terminal.



**Frame or chassis terminal.** This symbol indicates the frame or chassis terminal for connection to ground.



**Equipotentiality.** This symbol indicates an equipotentiality terminal.



**On (Supply).** This symbol indicates that the power line switch is ON.

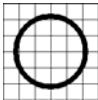

**Off (Supply).** This symbol indicates that the power line switch is OFF.



**Standby.** This symbol indicates that the power line switch is in STANDBY.



**Caution, risk of electric shock.** Danger – high voltage.

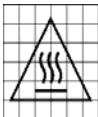

**Caution, hot surface.** Danger – high temperature surface.



**Caution (refer to accompanying documents).** Attention – refer to the manual. This symbol indicates that information about usage of a feature is contained in the manual.

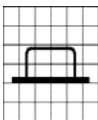

**In-position of a bistable push control.** This symbol indicates the in (on) position of a bistable push control.



**Out-position of a bistable push control.** This symbol indicates the out (off) position of a bistable push control.



**CE Mark.** <sup>TM</sup> of the European Community.



**Fuse Symbol.** To indicate a fuse.

# Warnings

**WARNING** Do not use the equipment in a manner not specified in this manual!

**WARNING** Equipment should only be serviced by authorized personnel.

**WARNING**



To avoid fire hazard, use only a fuse identical in type, voltage rating, and current rating as specified on the fuse rating label and/or in the manual.

## **Proper Power Cord**

Use only the power cord and connector appropriate for the voltage and plug configuration in your country. Use only a power cord that is in good condition. Refer cord and connector changes to qualified service personnel.

## **Do Not Operate in Explosive Atmospheres**

To avoid explosion, do not operate the equipment in an atmosphere of explosive gas.

## **Do Not Attempt to Operate if Protection may be Impaired.**

If the equipment appears damaged or operates abnormally, protection may be impaired. Do not attempt to operate it. When in doubt, have the equipment serviced.

## **Cleaning Warning**

Keep the equipment dry to avoid electrical shock to personnel or damage to the equipment. To prevent damage, never apply solvents to the equipment housing. For cleaning, wipe the equipment with a cloth that is lightly dampened with water, mild detergent, or alcohol. Do not use aromatic hydrocarbons, chlorinated solvents, or methanol-based fluids.

## **Operating Position**

Normal operating position is horizontal, on a flat surface. Vertical position is not considered normal operation.

**WARNING** This is a Safety Class 1 Product (provided with a protective earthing ground incorporated in the power cord). The mains plug shall only be inserted in a socket-outlet provided with a protective earth contact. Any interruption of the protective conductor inside or outside of the product is likely to make the product dangerous. Intentional interruption is prohibited.

**WARNING** Equipment is not intended for wet locations. Miscellaneous liquids on or in the equipment could cause hazardous conditions.

## **Safety Maintenance.**

The operator should check the detachable power supply cord condition. The equipment should not be operated if the mains inlet is cracked or broken. Any obvious damage to the case (from a drop or fall) should be checked by service personnel for loose or damaged parts inside. See parts lists for approved replacement parts.

**WARNING TO SERVICE PERSONNEL**

Ensure that power is disconnected before removal of any covers.

**WARNING**

The Power switch on the Front Panel is not the mains disconnect. Mains disconnect is accomplished by disconnecting the detachable power supply cord at the appliance coupler or at the mains plug. Ensure the power cord is easily accessible and removable, in the event of an emergency, which requires immediate disconnection.

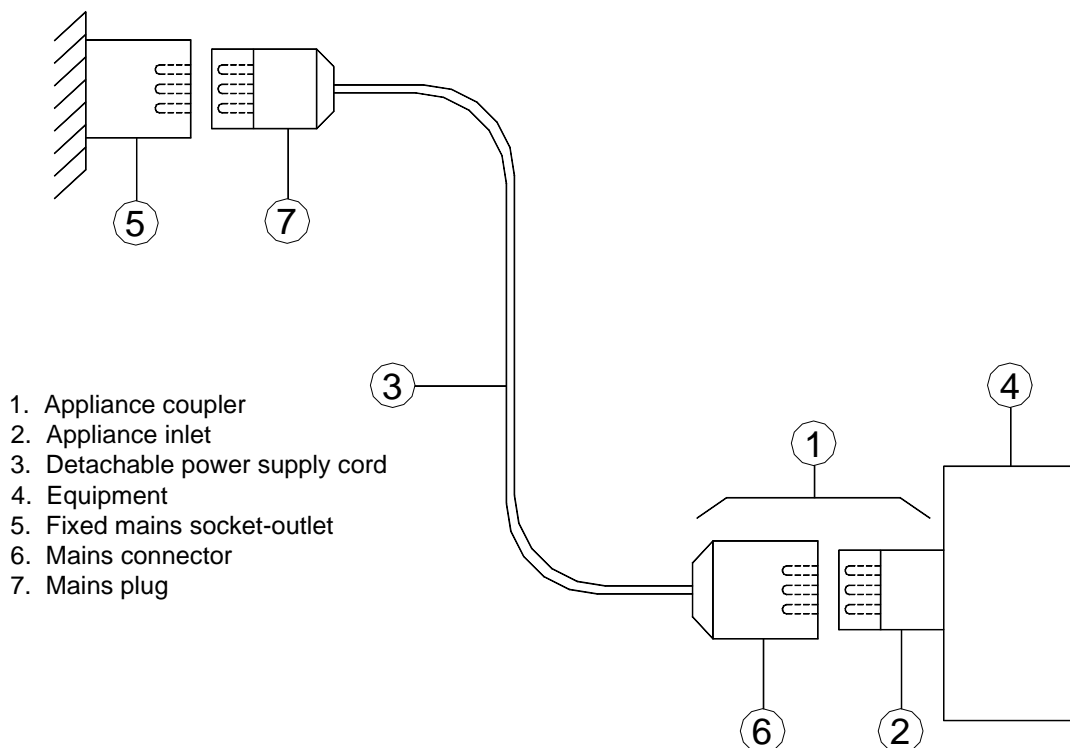

**NOTICE**

For the NAV 2000R – TA Unit (JPN 01-0520-TA):  
This equipment is type accepted in accordance with FCC Part 87 rules. In order to operate this equipment in the United States (transmit an over the air signal) a station license must be in effect for your location in accordance with FCC Part 87 rules.



**TABLE OF CONTENTS**

**SECTION I  
GENERAL INFORMATION**

SECTION	PAGE NUMBER
1.1	GENERAL INFORMATION ..... 1-1
1.2	EQUIPMENT DESCRIPTION ..... 1-1
1.3	TECHNICAL CHARACTERISTICS ..... 1-1
1.4	UNITS AND ACCESSORIES SUPPLIED ..... 1-6
1.5	UNITS AND ACCESSORIES REQUIRED ..... 1-6
1.6	OPTIONAL EQUIPMENT ..... 1-6
1.6	SERVICE INFORMATION..... 1-6

**SECTION II  
INSTALLATION**

2.1	GENERAL INFORMATION ..... 2-1
2.2	UNPACKING AND INSPECTION OF EQUIPMENT ..... 2-1
2.3	EQUIPMENT INSTALLATION ..... 2-1
2.4	POST INSTALLATION CHECK ..... 2-1

**SECTION III  
OPERATION**

3.1	GENERAL INFORMATION ..... 3-1
3.2	FRONT PANEL DESCRIPTION..... 3-1
3.3	REAR PANEL DESCRIPTION ..... 3-2
3.4	POWER UP PROCEDURE ..... 3-2
3.5	LOCAL USER INTERFACE ..... 3-3
3.5.1	NAV 2000R MODES ..... 3-3
3.5.2	MENU LAYOUT DESCRIPTION..... 3-3
3.5.3	GETTING AROUND IN THE MENUS ..... 3-4
3.5.4	CHANGING FIELD DATA / ALPHANUMERIC ..... 3-5
3.5.4.1	EDITING NUMERIC OR ALPHANUMERIC FIELDS ..... 3-5
3.5.4.2	ENTERING FIELD VALUES WITH THE KEYPAD ..... 3-6
3.5.4.3	TOGGLE FIELD EDITING..... 3-6
3.5.4.4	USING HOT KEYS ..... 3-6
3.5.4.5	RF LEVEL ENTRY ..... 3-7
3.5.5	VOR MODE FIELD DEFINITIONS..... 3-7
3.5.6	VOR AUDIO CONTROL MODE (VORa) FIELD DEFINITION..... 3-9
3.5.7	LOCALIZER MODE FIELD DEFINITION ..... 3-10
3.5.8	LOC AUDIO CONTROL MODE (LOCa) FIELD DEFINITION ..... 3-13
3.5.9	GLIDESLOPE MODE FIELD DEFINITIONS..... 3-14
3.5.10	ADF MODE FIELD DEFINITIONS ..... 3-15
3.5.11	MARKER BEACON MODE FIELD DEFINITION ..... 3-17
3.5.12	COMMUNICATION MODE FIELD DEFINITION..... 3-18
3.5.13	SELCAL MODE ..... 3-19
3.5.14	UTILITY MENU..... 3-21
3.5.15	EXTERNAL MODULATION MODE..... 3-23
3.5.16	CALIBRATION MODE..... 3-23
3.5.17	DISPLAY DEFINITION DURING POWER ON SEQUENCE ..... 3-24

### SECTION III OPERATION (Con't)

SECTION	PAGE NUMBER
3.5.18	STORING & RECALLING SETUPS..... 3-24
3.6	REMOTE USER INTERFACE..... 3-24
3.6.1	GPIB REMOTE INTERFACE DESCRIPTION ..... 3-24
3.6.2	COMMAND LIST ..... 3-25
3.7	USING THE EXTERNAL AUDIO INPUT..... 3-34
3.8	USING AUDIO OUTPUT ..... 3-35

### SECTION IV THEORY OF OPERATION

4.1	GENERAL INFORMATION ..... 4-1
4.2	UNIT DESCRIPTION..... 4-1
4.2.1	FRONT PANEL ..... 4-1
4.2.2	REAR PANEL ..... 4-1
4.2.3	CHASSIS INTERIOR LAYOUT ..... 4-1
4.3	FUNCTIONAL DESCRIPTION ..... 4-2
4.3.1	RF OUTPUT LEVEL..... 4-2
4.3.2	FREQUENCY ..... 4-2
4.3.3	VOR SIGNAL GENERATOR..... 4-2
4.3.4	ILS SIGNAL GENERATOR ..... 4-2
4.3.5	COM SIGNAL GENERATOR ..... 4-3
4.3.6	SYSTEM COMPUTER BOARD THEORY OF OPERATION..... 4-3
4.3.7	DSP BOARD THEORY OF OPERATION ..... 4-4
4.3.8	RF MODULATOR MODULE DESCRIPTION ..... 4-5
4.3.9	MODULATOR GENERAL OPERATIONAL DESCRIPTION..... 4-6
4.3.10	AUDIO BOARD OPERATION ..... 4-6
4.3.11	RF MODULATOR BOARD OPERATION..... 4-7
4.3.12	PROGRAMMABLE STEP ATTENUATOR CIRCUIT ..... 4-8
4.3.13	SYNTHESIZER ..... 4-8
4.3.14	REVERSE POWER PROTECTION MODULE OPERATION (-50 UNIT WITH MOD STATUS 7 ONLY)..... 4-10
4.4	NAV 2000R SOFTWARE ..... 4-10
4.4.1	SELF TEST..... 4-10
4.4.2	CALIBRATION..... 4-11
4.4.3	MEMORY USAGE AND INITIALIZATION..... 4-11
4.5	DETAILED CIRCUIT DESCRIPTION..... 4-12
4.5.1	MOTHER BOARD CIRCUIT DESCRIPTION..... 4-13
4.5.2	SYSTEM COMPUTER (CPU) BOARD CIRCUIT DESCRIPTION..... 4-13
4.5.3	DSP BOARD CIRCUIT DESCRIPTION ..... 4-14
4.5.4	RF MODULATOR MODULE CIRCUIT DESCRIPTION..... 4-15
4.5.5	RF MODULATOR MODULE BLOCK DIAGRAM ..... 4-15
4.5.6	RF MODULATOR MODULE BUS INTERFACE CIRCUITRY (AUDIO BOARD - A1) ..... 4-15
4.5.7	EXTERNAL AUDIO CONTROL ..... 4-16
4.5.8	INTERNAL & EXTERNAL MODULATION SUMMING..... 4-16
4.5.9	AUDIO HIGH/LOW INDICATION ..... 4-16
4.5.10	% MODULATION LEVEL SET ATTENUATOR ..... 4-17
4.5.11	% MODULATION CENTERING & CALIBRATION ..... 4-17

**SECTION IV  
THEORY OF OPERATION (Con't)**

SECTION	PAGE NUMBER
4.5.12	VOLTAGE REFERENCE ..... 4-17
4.5.13	DETECTED AUDIO HI/LO INDICATION ..... 4-18
4.5.14	PROGRAMMABLE STEP ATTENUATOR CONTROL ..... 4-18
4.5.15	RF MODULATOR BOARD ..... 4-18
4.5.16	MODULATING SIGNAL TEMP. COMPENSATION NETWORK ..... 4-18
4.5.17	AUDIO MODULATED AMPLIFIER ..... 4-19
4.5.18	RF LEVELING AMPLIFIER ..... 4-20
4.5.19	FIXED GAIN AMPLIFIERS ..... 4-20
4.5.20	DETECTOR ..... 4-20
4.5.21	LPF & INTEGRATOR ..... 4-21
4.5.22	SCALING & RF LEVEL SET ..... 4-21
4.5.23	RF HIGH/LOW INDICATION ..... 4-22
4.6	PROGRAMMABLE STEP ATTENUATOR ..... 4-22
4.7	SYNTHESIZER CIRCUITS ..... 4-22
4.7.1	REFERENCE/CONTROL BOARD CIRCUITS ..... 4-22
4.7.2	RF/OUTPUT BOARD CIRCUITS ..... 4-23
4.7.3	MAIN VCO ..... 4-25
4.7.4	400 MHz VCO ..... 4-25
4.8	REVERSE POWER PROTECTION (-50 UNIT WITH MOD STATUS 7) ..... 4-25

**SECTION V  
MAINTENANCE INFORMATION**

5.1	BILLS OF MAT, ASSY DWGS, SCHEMATICS & TEST PROCED ..... 5-1
-----	---

**APPENDIX A**

	GPIB COMMAND QUICK REFERENCE ..... A-1
--	--

## SECTION I GENERAL INFORMATION

### 1.1 GENERAL INFORMATION

The Aeroflex NAV 2000R generates ADF, MARKER BEACON, HF/VHF, COM and SELCAL signals for test applications.

### 1.2 EQUIPMENT DESCRIPTION

The NAV 2000R VOR/ILS/COM Signal Generator contains necessary hardware and firmware to provide modulated RF signals to verify operation of VOR navigational, ILS (Glideslope, Localizer, and Marker Beacon), and COM communications LRU systems for aircraft. An external modulation signal can either be summed with internal audio signals or separately controlled. The modulated RF output is connected directly to the LRU. The NAV 2000R can be locally or remotely operated.

### 1.3 TECHNICAL CHARACTERISTICS

#### Mains Fuses



The equipment uses two type F, 1.6 A, 250 V, 5 mm X 20 mm fuses (A1F1 and A1F2).

To replace these fuses, which are located on the rear panel inside the Appliance Inlet (A1FL1):

1. disconnect the appliance coupler.
2. With a flat blade screwdriver, or similar tool, open the cover.
3. With a flat blade screwdriver, or similar tool, remove the fuse holder/power input selection subassembly.
4. Replace fuse(s) with kind indicated above.
5. Replace the fuse holder/power input selection subassembly so that voltage selected appears in window when the cover is snapped into place.

#### Ac Power Source

The equipment is intended to operate from an ac power source that will not apply more than 253 V ac between the supply conductors or between either supply conductor and ground. A protective ground connection by way of the grounding conductor in the power cord is required for safe operation.

#### Environmental Specifications

The environmental specifications are as follows.

Operating Temperature

5 °C to 40 °C.

Storage Temperature

-20 °C to +85 °C.

Relative Humidity

Maximum of 80% for temperatures up to 31 °C decreasing linearly to 50% at 40 °C.

Operating Altitude

2 000 m maximum.

Size

14.5 cm H x 44.2 cm W x 49.0 cm D  
(5.7" H x 17.4" W x 19.3" D)

## Aeroflex Operation Manual

Mass (Weight)	61.2 kg (135 lbs.)
Ventilation Requirements	Keep the ventilation openings clear.
IEC Overvoltage Category	II
Pollution Degree	1
Equipment Meets These Listed Standards	EN 61010-1 (IEC 61010-1) EN 61328 EN 61326 Class A
Cables and Wires	<ol style="list-style-type: none"><li>1. It is recommended that all cables connecting to the AUDIO OUTPUT (A3J5), EXTERNAL MOD INPUT (A4A2P1), 10 MHZ OUT (A5A1J7), and 10 MHZ IN (A5A1J6) terminals (ports) use M17/84-RG223 double shielded coaxial cable, or equivalent, properly terminated to BNC connectors.</li><li>2. It is recommended that the cable connecting to the RF OUTPUT (A1J1) terminals (port) use M17/75-RG214 double shielded coaxial cable, or equivalent, properly terminated to N connectors.</li></ol>
Warm Up Duration	30 min minimum for specified performance.
Nonvolatile Memory Life	10 years minimum data retention in the absence of external power.
Data Input / Output	Compatible with IEEE Standard 488-1978
Electrical Specifications	
Power Requirements	115/230 V 60/50 Hz 750 mA max, 70 W
	

## Aeroflex Operation Manual

### Mains Input Selection

Selection of mains input range is done at the appliance inlet (A1FL1) on the back panel. For 115 V ac  $\pm 10\%$ , set the selector to the 115 V position. For 230 V ac  $\pm 10\%$ , set the selector to the 230 V position. Either selection will accept 50 or 60 Hz.

To change the voltage selection:

1. Disconnect the appliance coupler.
2. With a flat blade screwdriver, or similar tool, open the cover.
3. With a flat blade screwdriver, or similar tool, remove the fuse holder/power input selection subassembly.
4. Rotate the assembly and push it back into position.
5. Check that the voltage selected appears in the voltage selection window when the cover is snapped into place.

Max RF OUTPUT Safe Input Power  
 -50 (W/MOD STATUS 7)  
 -TA

50 W, 50 V dc  
 200 mW, 0 V dc

### RF Frequency

Output Frequency Range	150 kHz to 450 MHz
Frequency Resolution	10 Hz
Frequency Drift	$\pm 2.5$ ppm
Reference Aging	$\pm 1$ ppm per year

### Time Base

External Reference Input	10 MHz $\pm 2.5$ ppm (BNC/female connector on backpanel) -2 dBm to +20 dBm 5 V dc max
Internal Reference Output	10 MHz, 0 dBm minimum.

### RF Output level

0 dBm to -127 dBm

#### Accuracy

0 dBm to -64 dBm	$\pm 1.0$ dB
-64 dBm to -110 dBm	$\pm 2.0$ dB
-110 dBm to -127 dBm	$\pm 3.0$ dB

#### Level resolution

0.1 dB

#### Settling Time

< 250 ms

#### SWR

< 1.5:1

#### Output Impedance

50  $\Omega$

### Spectral purity

Harmonics	< -30 dBc
Non-harmonics	< -60 dBc at > 5 kHz from carrier
SSB Phase Noise	< -115 dBc/Hz at > 25 kHz from carrier (CW only)

Aeroflex Operation Manual

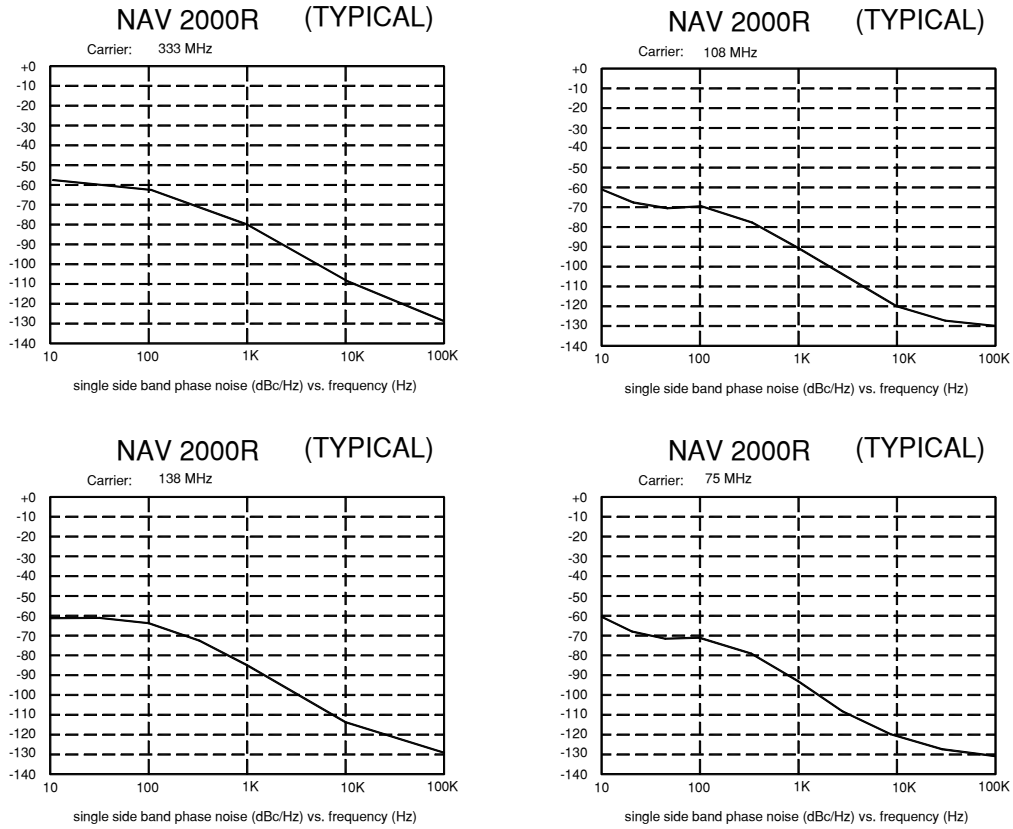

**FIGURE 1-1: TYPICAL GRAPH FIGURES**

Residual FM

0.15 - 56.25 MHz  
 56.25 - 112.50 MHz  
 112.50 - 225.00 MHz  
 225.00 - 450.00 MHz

< 25 Hz at 0.05 - 15 kHz  
 < 10 Hz Post Detection  
 < 16 Hz Noise BW  
 < 25 Hz

Residual AM

< 0.1% 0.05 - 15 kHz Noise BW

VOR mode

Modulation tones

Frequencies  
 Frequency Accuracy  
 Frequency Adjustment Range  
 Distortion(audio)  
 9960 Hz FM deviation

30 Hz reference, 30 Hz variable, 9960 Hz, and  
 1020 Hz IDENT  
 ± 0.005%  
 ± 10% Aux. Audio = 10 Hz -18000 Hz  
 < 0.1% THD  
 480 ± 1 Hz at default frequencies

Radial range

000.00 to 359.99 degrees (selectable at each 30 degree heading or in 0.01 degree increments)

Radial accuracy (Audio)

± 0.01 degree relative to calibration standard used during calibration.

Radial accuracy (RF)

± 0.05 degree relative to calibration standard used during calibration.

## Aeroflex Operation Manual

Amplitude Modulation	
Range (per tone)	total % mod not to exceed 99%
1020 Hz IDENT	0-99%, Default 30%
30 Hz variable	0-99%, Default 30%
9960 Hz	0-99%, Default 30%
Resolution	0.01%
Overall accuracy	± 2% of setting for 10% to 95% AM
Tone distortion	2% maximum
(RF at default)	
Total VOR demodulated error	< ±0.05 degree of selected radial
LOCALIZER mode	
Modulation tones	
Frequencies	90 Hz, 150 Hz, and 1020 Hz ident
Frequency accuracy	± 0.005%
Frequency adjustment Range	± 10% Aux. Audio = 10 Hz -18000 Hz
Distortion (audio)	< 0.1% THD
90/150 Hz phase	
Fixed	0.0 ± 0.01 degree
Variable Resolution	0.01 degree
Variable Accuracy	±0.05 degrees
Amplitude modulation	
Range (per tone)	total % mod not to exceed 99%
90 and 150 Hz	
Default	20%
Variable	0 to 99% in 0.01% increments
1020 Hz	
Default	30%
Variable	0 to 99% in 0.01% increments
Accuracy (sum of all tones)	± 2% of setting for 10% to 95%
Tone distortion	2% maximum
(RF at default)	
DDM	
Default	0.000 DDM
Selectable settings	0.000, 0.046, 0.093, 0.155, 0.200 DDM
Variable range	0.400 in 0.001 increments
Total system error	
(audio + modulation)	±0.0003 @ 0 DDM
	±0.0012 @ 0.046 DDM
	±0.0021 @ 0.093 DDM
	±0.0034 @ 0.155 DDM
	±0.0053 @ 0.200 DDM
GLIDESLOPE mode	
Modulation tones	
Frequencies	90 Hz, 150 Hz
Frequency accuracy	± 0.005%
Frequency adjustment range	± 10%
Distortion (audio)	< 0.1% THD



## Aeroflex Operation Manual

90/150 Hz phase		
Fixed		0.0 ± 0.01 degree
Variable resolution		0.01 degree
Variable accuracy		± 0.05 degrees
Amplitude modulation		
Range (per tone)		total % mod not to exceed 99%
90 and 150 Hz		
Default		40%
Variable		0 to 99% in 0.01% increments
Accuracy (sum of all tones)		± 2% of setting for 10% to 95%
Tone distortion		2% maximum
(RF at default)		
DDM		
Default		0.000 DDM
Selectable settings		0.000, 0.045, 0.091, 0.175, 0.400 DDM
Variable range		0.800 in 0.001 increments
Total system error		
(audio + modulation)		± 0.0003 @ 0 DDM
		± 0.0012 @ 0.045 DDM
		± 0.0021 @ 0.091 DDM
		± 0.0038 @ 0.175 DDM
		± 0.0083 @ 0.400 DDM
ADF		
Modulation tone		
Preset		1000 Hz
Variable		10 Hz to 18 kHz (0.1 Hz increments)
Frequency accuracy		± 0.005%
Distortion (audio, 10 Hz to 10 kHz)		< 0.1% THD
Amplitude modulation		
Range		
Preset		95%
Variable		0 to 99% in 0.01% increments
Accuracy		± 2% of setting for 10% to 95%
MARKER BEACON		
Modulation tone		
Frequencies		400/1300/3000 Hz
Frequency Adjustment Range		10 Hz to 18 kHz
Adjustment Resolution		0.1 Hz
Frequency Accuracy		± 0.005%
Distortion (audio only)		< 0.1% THD
Amplitude modulation		
Range		
Preset		95%
Variable		0 to 99% in 0.01% increments

## Aeroflex Operation Manual

### COMM

#### Modulation tones (two tones selectable)

Preset	1000 Hz and 2000 Hz
Variable	10 Hz to 18 kHz (0.1 Hz increments)
Frequency accuracy	$\pm 0.005\%$
Distortion (audio, 10 Hz to 10 kHz)	$< 0.1\%$ THD

#### Amplitude modulation

Range	total % mod not to exceed 99%
Preset @ 1000 Hz	30%
Variable 10 to 18 kHz	0 to 99% in 0.01% increments
Accuracy	$\pm 2\%$ of setting for 10% to 95%

#### External modulation

Input impedance	5 k $\Omega$
Maximum modulation depth	99%
Modulation distortion	2% maximum
Modulation bandwidth	10 Hz to 22 kHz
Input level	1 V peak

#### Morse Code (ident) - Programmable in VOR, Localizer or ADF mode

Max Length	6 characters
Rate	programmable
Dot/Dash/spacing times	individually programmable

Audio Output Level 1.414  $\pm$  0.025 V rms into 600  $\Omega$ . Adjustable downward in audio modes

## 1.4 UNITS AND ACCESSORIES SUPPLIED

NAV 2000R VOR/ILS/COM Generator	JPN 01-0520-50
NAV 2000R CD Operation Manual	JPN E6-0520-5A
Detachable Power Supply Cord	

## 1.5 UNITS AND ACCESSORIES REQUIRED

The NAV 2000R requires the following items to be interconnected to a remotely operated test equipment environment.

ITEM	DESCRIPTION	TYPE
1	GPIB Cable	It is recommended that a HP type 10833X braided shield cable, or equivalent, be used.

## 1.6 OPTIONAL EQUIPMENT

ITEM	DESCRIPTION	TYPE
1	Extender Board	JPN 20-5760-00

## 1.7 SERVICE INFORMATION

If you have any questions regarding service, you may contact the factory at the address listed below:

Aeroflex  
400 New Century Parkway  
New Century, KS 66031

Phone: (913) 764-2452  
Fax: (913) 782-5104  
<http://www.aeroflex.com>

## **SECTION II INSTALLATION**

### **2.1 GENERAL INFORMATION**

This section contains information relating to the unpacking, inspection, and installation of the Aeroflex NAV 2000R VOR/ILS/COM Generator.

### **2.2 UNPACKING AND INSPECTION OF EQUIPMENT**

Exercise extreme care when unpacking the unit and accessories. Make a visual inspection of the NAV 2000R for evidence of damage incurred during shipment. If a claim for damage is to be filed, save the shipping container to substantiate the claim. When all the equipment has been unpacked, return all the packing material to the container for future use in storing and shipping the equipment.

### **2.3 EQUIPMENT INSTALLATION**

The NAV 2000R VOR/ILS/COM generator is manufactured as a bench test unit, but may be rack mounted using optional rack mount handle flanges.

### **2.4 POST INSTALLATION CHECK**

After completing installation of the Aeroflex NAV 2000R VOR/ILS/COM Generator, a power-up self-test verifies its operation. The NAV 2000R display will identify any problems found during the power-up self-test.

## SECTION III OPERATION

### 3.1 GENERAL INFORMATION

This Section describes how to operate the NAV 2000R VOR/ILS/COM generator. It contains information for an initial inspection, general operating information, and local and remote operation. The NAV 2000R can be operated using either the local user interface or the remote user interface. The local user interface uses the front panel keypads and display. The remote interface uses a General Purpose Interface Bus (GPIB). Throughout this manual, GPIB shall be used to mean an interface bus conforming to IEEE Standard 488-1978, "Standard Digital Interface For Programmable Instrumentation."

### 3.2 FRONT PANEL DESCRIPTION

Figure 3-1 shows the NAV 2000R front panel. Shown on the Figure are the display (including its fields), the mode select keypad, cursor keypad and select key, hot keys keypad, numeric keypad, power switch, and RF output connector.

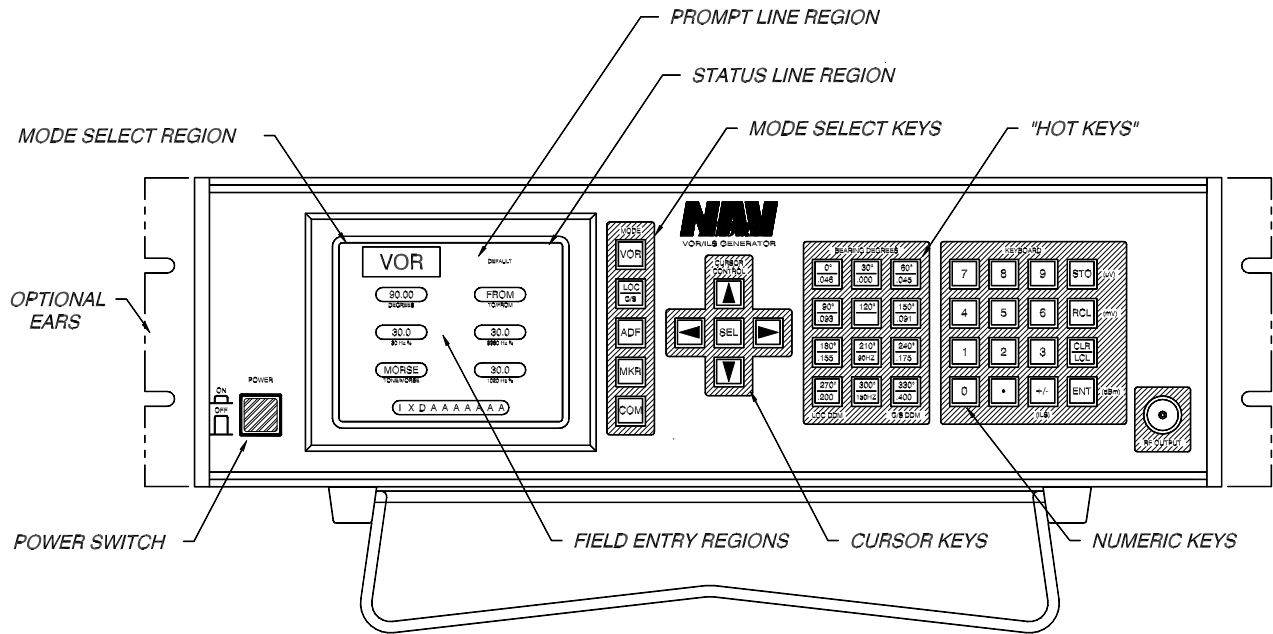

**FIGURE 3-1: FRONT PANEL**

### 3.3 REAR PANEL DESCRIPTION

Figure 3-2 shows the NAV 2000R rear panel. Shown on the Figure are the modules, external modulation input, audio output, power connection, and GPIB bus connector.

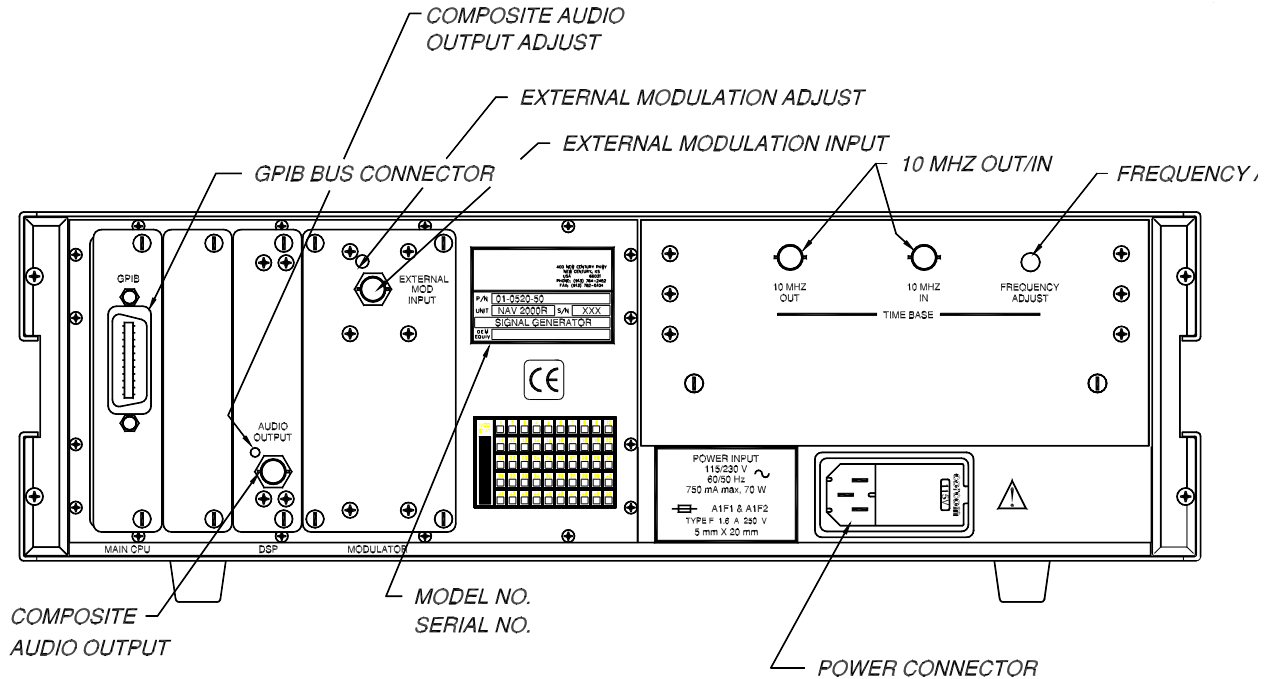

**FIGURE 3-2: REAR PANEL**

### 3.4 POWER UP PROCEDURE

Before turning on the power to the NAV 2000R, ensure that the proper mains power is applied. Configure the unit for the input voltage to be used.

To turn on the NAV 2000R, press the power button located at the bottom left corner of the front panel. Upon power up, the NAV 2000R will perform a self-test and when complete will indicate self-test results on the display.

### 3.5 LOCAL USER INTERFACE

Local operation of the NAV 2000R consists of using the display and keypads for entry. Four groups of keypads allow control of mode, display cursor, quick entry, and numeric entry. The display is menu driven with selectable data fields on each menu page.

Parametric data is entered using front panel keypads and display. Selectable options are surrounded by "bubbles". Each bubble represents a field that the user may select and change. Located underneath each selectable field is a field identifier. Navigating the menus is discussed below.

### 3.5.1 NAV 2000R MODES

The NAV 2000R local operation is menu driven through the use of mode menu pages. There are six generator modes and three utility modes. Each top level generator mode menu is accessed by pressing the corresponding mode menu select key. With the exception of G/S, the LOC/GS key toggles between LOC and G/S modes. These are aligned vertically and to the right of the display. The main generator modes are: VOR, LOCalizer (LOC), Glide Slope (G/S), ADF, MarKeR beacon (MKR) and COMMunications (COM). The utility menu can be accessed by pressing and holding any of the generator mode select keys, except for the LOC/GS key, for two seconds. Two additional modes, External Modulation Mode (EMM) and CALibration mode (CAL), are accessible from the utility menu. Also, VOR and LOC modes have alternate control modes to allow control of their audio composite output signals. These modes, VORa and LOCa, are accessed by selecting the audio control mode bubble from within their 1st page. The SELCAL mode is accessed from the SELCAL bubble in PAGE 1 of the COM mode menus.

### 3.5.2 MENU LAYOUT DESCRIPTION

Every display menu page can be broken into four different partitions: the Selected Mode Region, the Status Line Region, the Prompt Line Region, and the Field Entry Region.

On each menu page, there are multiple fields. If more than one page is needed to access all fields of a given mode, one of the fields will be the next page field.

#### DISPLAY REGION: Selected Mode Display

The Mode Select region is located in the upper left-hand corner of the display. This region indicates the NAV 2000R current mode of operation. Distinguishing it from the other regions, the selected mode region is displayed using inverse video. The character assignments for each mode are:

<b>MODE</b>	<b>ABBREVIATION</b>
VOR	VOR
VOR audio control	VORa
Localizer	LOC
Localizer audio control	LOCa
Glideslope	G/S
ADF	ADF
Marker Beacon	MKR
Communication	COM
Ext. Modulation Mode	EMM
Calibration	CAL
Selective Calling	SCL

### **DISPLAY REGION: Status Line**

The status line enunciates certain NAV 2000R status conditions by using status flags. These flags are made from grouped alphanumeric characters. In some cases the annunciation involves flashing to attract attention. The flags, and their description, are detailed in this section.

### **EDIT ENUNCIATOR**

The EDIT flag is enunciated whenever the user is editing a field.

### **VAL FLAG**

The VAL flag is displayed whenever field values are set to a non-standard value, as defined by the current system mode of operation. For example, it would be set during VOR mode when the user requests an audio frequency deviating from the standard VOR frequencies.

### **REGXX or DEFLT FLAG**

The REGXX flag is displayed whenever the user has stored or recalled a NAV 2000R setup register. For example, after the user has recalled setup #1, the status line would display the setup register flag REG01. When register # 00 is recalled, DEFLT is displayed indicating that the NAV 2000R has been set to its factory default settings.

### **REMOTE FLAG**

This flag is set anytime a remote application program has commanded the NAV 2000R via the GPIB bus. During remote operation all front panel keyboard controls are locked out. The CLR/LCL key, the only key recognized during remote mode, will force the system back to local control.

### **EMΣ**

Indicates that an audio signal applied to the EXTERNAL MOD INPUT will be summed with internal audio and applied to the AM modulator.

### **DISPLAY REGION: Prompt line**

The prompt line region is located directly below the status line and displays special warnings or errors that may arise during editing and controlling of the NAV 2000R.

## **3.5.3 GETTING AROUND IN THE MENUS**

All front panel user inputs to the NAV 2000R are entered through selection of menu page fields. Each mode of operation has a set of pre-defined user programmable items. These items are programmed through the menu page display fields. VOR, LOC, G/S, and ADF generator modes have multiple menu pages which provide access to all modifiable items. To access the next page, a "NEXT PAGE" menu field is provided.

To display pages of the VOR, LOC, G/S, ADF, MKR, or COM menus, the appropriate mode select key is pressed. (The mode select keypad is aligned along the right side of display). To move between different mode pages for VOR, LOC, G/S and ADF use the cursor keypad to highlight the "NEXT PAGE" field and press SEL (select).



To display the utility menu, any one of four generator mode keys [VOR, ADF, MKR, or COM] is pressed and held down for two seconds. The external modulation (EMM) mode and the calibration (CAL) mode can be entered from the utility menu by selecting the corresponding option on the menu. Pressing the number of the utility menu item will immediately select the menu option. Alternatively, the arrow keys can be used to move up and down the list until the desired item is highlighted and then the select (SEL) or enter (ENT) keys can be pressed to activate the selection. Further discussion of the Utility Menu may be found in Section 3.5.13.

To change the contents of a field, the cursor keypad is used to highlight the desired field. The user may change the data of the currently selected field in a manner which is dependent upon the type of data the field contains. There are four types of fields: Numeric, alphanumeric, discrete toggle, and next page.

### **3.5.4 CHANGING FIELD DATA / ALPHANUMERIC**

#### **3.5.4.1 EDITING NUMERIC OR ALPHANUMERIC FIELDS**

A Numeric menu field (any field containing a numeric value) can be modified using either the cursor keys or numeric keypad. This section details the use of the cursor keys to edit a field of existing data. The cursor keys may be used to edit existing field data. To edit a field, press the SEL key while the field of interest is highlighted.

Upon pressing the SEL key when a numeric or an alphanumeric field is highlighted, the edit mode is entered and enunciated by the EDIT prompt. Within the field selected for edit is a cursor, two blinking arrows, which indicates which character location is currently being edited.

The left and right arrow keys may be used to force the cursor to the character just left or right of the current cursor position. This allows the user to alter any digit or character within the field. If the user presses a numeric keypad button while editing, the digit will automatically be placed at the current cursor location.

A character under edit may also be changed by pressing the up or down arrow keys to advance to the next character or previous character, respectively. For numeric fields, the characters can be 0 - 9 and for alphanumeric fields, A through Z, 0 through 9, and the space character.

When editing numeric digits using the cursor, if the digit changes from 9 to 0 then a 1 is carried to the next significant digit. When changing alphanumeric digits with the cursors, the display will scroll through the 0 through 9 digits, A through Z, and the space character before starting over at 0.

The CLR key can be pressed to restore the original value of the field being cursor edited. To terminate cursor editing, press the SEL or ENT keys.

While editing, if the value of the numeric data moves outside its standard setting, two asterisks (\*\*) are displayed, one on each side of the field. The NAV 2000R output signal changes immediately during editing. This enables real time skewing of numeric parameters.

If the data in the numeric field being edited is at its lower limit then further decrementing with the down arrow cursor key will have no effect and the message "VALUE LIMITED TO MINIMUM" will appear briefly on the status line. If the data in the numeric field being edited is at its upper limit then further incrementing with the up arrow cursor key will have no effect and the message "VALUE LIMITED TO MAXIMUM" will appear briefly on the status line.

#### **NOTE:**

Numeric entry starts to the right side of the field and works left. However, alphanumeric entry starts to the left and works right.

### 3.5.4.2 ENTERING NUMERIC FIELD VALUES WITH THE KEYPAD

Numeric field values can be entered directly using the numeric keypad. To modify a numeric field with the numeric keypad the field is first selected using the cursor keys. The entry begins with a depression of the numeric keypad digit. The previous numeric field value will blank and the new numeric digit, the one which caused the edit entry, will be placed right justified. Each successive numeric key pressed will shift left and append the new key to the right-most character position. This append shifting will be allowed to continue for the full field width. If the user tries to enter more digits than will fit within the field, the leftmost character will be truncated.

Pressing the ENT (enter) key terminates the number entry. The CLR (clear) key erases the field allowing a number to be reentered. The arrow and edit keys will be ignored during numeric keypad entry. If the user presses the ENT key when the field is cleared of all numeric data, the field is restored to the value prior to edit mode entry. After the enter key is pressed, the system terminates edit mode.

After entering a numeric value, if the value of the numeric data moves outside its standard setting, two asterisks (\*) are displayed, one on each side of the field.

If the data entered into the numeric field is less than the minimum acceptable lower limit, the field will be set to its lower limit and the message "VALUE LIMITED TO MINIMUM" will appear briefly on the status line. If the data entered into the numeric field is greater than the maximum acceptable upper limit, the field will be set to its upper limit and the message "VALUE LIMITED TO MAXIMUM" will appear briefly on the status line.

### 3.5.4.3 TOGGLE FIELD EDITING

With toggle field editing, the field data toggles between items in a list. The list will be two or more items. To change a toggle field, the desired field is first highlighted using the cursor keypad. Then, the field contents are changed when the SEL (select) key is pressed. Items can be toggled by pressing the select key successively. The list toggles circularly so when the end of the list is reached, the first item will again be displayed.

The numeric keys of the numeric keypad have no function during toggle editing.

### 3.5.4.4 USING HOT KEYS

"HOT KEYS" provide a quick method to modify bearing or DDM to a standard setting. The keys are only recognized during VOR, LOC and G/S modes.

During the VOR mode, the hot keys allow the user to step through standard bearing check points without having to edit the bearing field. Anytime the VOR mode is selected, the user may press any degree key to automatically set the bearing field contents. Twelve different bearing settings are provided, these are: 0, 30, 60, 90, 120, 150, 180, 210, 240, 270, 300, and 330 degrees.

If LOC or G/S is the current mode, pressing one of the hot keys will automatically set the DDM to a preset value. The standard DDM keys for G/S are .000, .045, .091, .175, and .400. The standard DDM keys for LOC are .000, .046, .093, .155, and .200. If a DDM hot key is pressed which is not a standard DDM for the current mode the DDM value will be accepted but the message "NON-STANDARD DDM VALUE" will appear.

Pressing the 90 Hz or 150 Hz hot keys will toggle the indicated tone off or on.

### 3.5.4.5 RF LEVEL ENTRY

Most all of the modes have an RF level control bubble associated with them. This field allows the RF level to be programmed. The RF level may be programmed with 1/10th dBm resolution using either dBm or uV/mV units. DBm numbers are entered using the ENT key. Microvolts and millivolt numbers may be entered using the uV and mV keys (STO/RCL) respectively. The default displayed units (normally dBm) may be changed by pressing the SEL key and then pressing either the uV, mV, or dBm keys. The RF level field is "global" to the other modes which control RF level. That is, if the RF level is changed in one mode, it is changed for all the other modes alike.

### 3.5.5 VOR MODE FIELD DEFINITIONS

VOR test mode is entered by pressing and releasing the VOR mode button. This mode is used to test and align VOR receivers. The VOR mode parameter fields are described in this section.

#### PAGE 1:

#### RF LEVEL

This field allows the RF level to be programmed. The RF level may be programmed with 1/10th dBm resolution using either dBm or uV/mV units. DBm numbers are entered using the ENT key. Microvolts and millivolt numbers may be entered using the uV and mV keys (STO/RCL) respectively. The default displayed units (normally dBm) may be changed by pressing the SEL key and then pressing either the uV, mV, or dBm keys.

#### BEARING

The desired omni bearing is programmed from 0 to 359.99 degrees in 0.01 degree steps. The default bearing is 0 degrees.

#### TO/FROM

This field specifies whether the bearing reference is TO or FROM. This field is a discrete toggle type field and the default reference is set to 'FROM'.

#### FREQ. MHz

This field allows the RF frequency to be programmed. The RF frequency may be programmed in 0.00001 MHz steps within the NAV 2000R frequency range of 0.15000 MHz to 450.00000 MHz.

#### CHANNEL

This field steps the RF frequency output up and down in 50 KHz steps using the cursor control up and down arrow keys.

#### TOTAL %MOD

This field allows changing all the percent modulation fields respective to one another. That is, changing the total percent modulation will allow all current modulations to be changed equally, maintaining the ratios between one another. For example, suppose the 30 Hz modulation is set to 30%, 9960 Hz modulation is set to 20%, and the ident tone 1020 Hz modulation is set to 10%. This indicates a total sum of 60%. If the total percent modulation was changed from 60% to 30%, the new component percent modulations would be 15%, 10%, and 5% respectively.

## **AUDIO**

Selecting the audio control mode field places the NAV 2000R into VOR audio control mode. The audio control mode, designated as the "VORa" mode, commands the NAV 2000R to allow the VOR audio composite output to be varied. Within this mode, RF control is not allowed and the RF attenuator is fixed for a minimum output level of -127 dBm. Also, no identification coding is allowed. The alternate VOR mode of operation will continue until the VOR button is pushed while the VORa control page is selected.

### **PAGE 2:**

#### **30 Hz FREQUENCY**

Programs the 30 Hz frequency. The user may specify a frequency from within the 24.0 Hz to 36.0 Hz range, with a resolution of 0.1 Hz. Any frequency, other than the default setting of 30.0 Hz, will cause the VAL flag to be enunciated.

#### **30 Hz %MOD**

Programs the desired 30 Hz tone percent of modulation. This is a numeric field type and is programmable from 0 to 99% in 0.01% steps. The default for this field is 30%. The "VALUE LIMITED TO MAXIMUM" error will be displayed if the user tries to enter a 30 Hz percent modulation value causing the total modulation to be more than 99% modulation. In this case, the system limits the 30 Hz modulation field to a value that forces all modulation percents to total 99%.

#### **9960 Hz FREQUENCY**

Programs the 9960 Hz center frequency. The user may specify a frequency from within the 7968.0 Hz to 11952.0 Hz range, with a resolution of 0.1 Hz. Any frequency, other than the default setting of 9.960 KHz, will cause the VAL flag to enunciate.

#### **9960 Hz %MOD**

Programs the desired 9960 Hz tone percent of modulation. This is a numeric field type and is programmable from 0 to 99% in 0.01% steps. The default for this field is 30%. The "VALUE LIMITED TO MAXIMUM" error will be displayed if the user tries to enter a 9960 Hz percent modulation value causing the total modulation to be more than 99% modulation. In this case, the system limits the 9960 Hz modulation field to a value that forces all modulation percents to total 99%.

#### **1020 Hz FREQUENCY**

Programs the 1020 Hz frequency. The user may specify a frequency from 10.0 Hz to 18000.0 Hz with 0.1 Hz step resolution. Any frequency, other than the default setting of 1020.0 Hz, will cause the VAL flag to enunciate.

#### **1020 Hz %MOD**

Programs the desired 1020 Hz tone percent of modulation. This is a numeric field type and is programmable from 0 to 99% in 0.01% steps. The "VALUE LIMITED TO MAXIMUM" error will be displayed if the user tries to enter a 1020 Hz percent modulation value greater than 99% or a modulation value causing the total modulation to be more than 99% modulation. In this case, the system will limit the 1020 Hz modulation to a value that causes all modulation percents to total 99%.

## **IDENT MODE**

Allows the user to specify how the identification tone is to be modulated. This is a toggle type field containing three valid options: OFF, CODE, and TONE. A selection of OFF, the default setting, commands the NAV 2000R to force the percent of modulation to 0%. A selection of CODE, causes the NAV 2000R to Morse code modulate using the specified identification string. A selection of TONE, commands the NAV 2000R to modulate a steady tone.

## **PAGE 3:**

## **IDENT CODE**

The identification field contains the identification string transmitted. The field uses the alphanumeric field entry method. The characters allowed in the string are 0 - 9, or A - Z. The maximum number of characters allowed is six. The default for this field is the ASCII string "JCAIR". The "space" character may be entered either at the beginning or end to allow entry of character strings shorter than six.

## **WORD RATE**

Allows the programming of the repetition rate at which the morse code identifier is transmitted. The valid range for the field is from 1 to 65 seconds programmable with 0.1 second step resolution. The default setting is 30 seconds.

## **DOT TIME**

Allows programming of the Morse code dot time in milliseconds. The valid range is from 50 ms to 250 ms with 1 ms resolution steps. The default value is 150 ms.

## **DASH TIME**

Allows programming of the Morse code dash time in milliseconds. The valid range is from 150 ms to 750 ms with 1 ms resolution steps. The default setting is 450 ms.

## **SPACING DOT/DASH**

Programs delay time between dots and dashes within Morse code characters. The valid range is from 50 ms to 250 ms with 1 ms resolution steps. The default setting is 150 ms.

## **SPACING CHARACTER**

Programs delay time between Morse code characters. The valid range is from 50 ms to 250 ms with 1 ms resolution steps. The default setting is 450 ms.

### 3.5.6 VOR AUDIO CONTROL MODE (VORa) FIELD DEFINITION

The VOR audio control mode, VORa, is entered by pressing and releasing the SEL key while the AUDIO control mode field, on VOR page 1, is selected. This mode allows the user to specify the NAV 2000R audio output signal level using volts RMS. No RF level control is allowed while within this mode of operation.

#### COMPOSITE AUDIO CONTROL:

##### AUDIO LEVEL

This field allows the audio signal level to be changed. The value entered represents  $V_{rms}$  of the VOR composite signal with both 30 Hz and 9960 Hz signals selected on.

##### BEARING

The desired omni bearing is programmed from 0 to 359.99 degrees in 0.01 degree steps. The default bearing is 0 degrees.

##### TO/FROM

Specifies whether the bearing reference is TO or FROM. This field is a discrete toggle type field and the default reference is set to 'FROM'.

##### 30 Hz MOD

Specifies whether the 30 Hz signal is to be modulated. The field toggles between ON and OFF whenever the SEL key is pressed while the field is selected.

##### 9960 Hz MOD

Specifies whether the 9960 Hz signal is to be modulated. The field toggles between ON and OFF whenever the SEL key is pressed while the field is selected.

### 3.5.7 LOCALIZER MODE FIELD DEFINITION

Localizer test mode is entered by pressing and releasing the LOC mode select button. This mode is used to test and align the Localizer portion of ILS equipment.

#### PAGE 1:

##### RF LEVEL

This field allows the RF level to be programmed. The RF level may be programmed with 1/10th dBm resolution using either dBm or uV/mV units. DBm numbers are entered using the ENT key. Microvolts and millivolt numbers may be entered using the uV and mV keys (STO/RCL) respectively. The default displayed units (normally dBm) may be changed by pressing the SEL key and then pressing either the uV, mV, or dBm keys.

## **DDM**

Programs the %MOD of the 90 and 150 Hz tones. The valid entry range for this field is from .000 to .400 DDM (Difference in Depth of Modulation) with .001 resolution. The NAV 2000R computes the percent of modulation ratio between the 90 and 150 Hz required to produce the commanded DDM. The percent of modulation of each tone will be set to the proper ratio forcing both tones to total the standard modulation of 40%. The default value for this field is .000 DDM, 20% modulation for each tone.

When a valid Localizer DDM "hot" key is pressed, the DDM will automatically be accepted. If a G/S DDM "hot" key is pressed, the system will accept it and will display, momentarily on the prompt line, the warning message: "NON-STANDARD DDM VALUE". Pressing the 90 or 150 Hz "hot" key will alternately shut off or turn on that tone to allow quick testing of a drop out of either tone at preset DDMs.

## **LEFT/RIGHT**

Specifies whether the Localizer reference is either LEFT/150 or RIGHT/90. When this toggle type field is selected, the current 90 and 150 Hz %MOD data fields are switched. The default value is LEFT/150.

## **FREQ. MHz**

This field allows the RF frequency to be programmed. The RF frequency may be programmed in 0.00001 MHz steps within the NAV 2000R frequency range of .15 MHz to 450 MHz.

## **CHANNEL**

This field steps the RF frequency output up and down in 50 kHz steps using the cursor control up and down arrow keys.

## **TOTAL %MOD**

This field allows changing all the percent modulation fields respective to one another. That is, changing the total percent modulation will allow all current modulations to be changed equally, maintaining the ratios between one another.

## **AUDIO**

Selecting the audio control mode field alters the NAV 2000R's Localizer mode of operation. The audio control mode, designated as the "LOCa" mode, commands the NAV 2000R to allow the Localizer audio composite output to be varied. Within this mode, RF control is not allowed and the RF attenuator is fixed for a minimum RF output level of -127 dBm. Also, no identification coding is allowed. The alternate LOC mode of operation will continue until the LOC button is pushed while the LOCa control page is selected.

## **PAGE 2:**

### **90 Hz FREQUENCY**

Programs the 90 Hz frequency. A frequency from 72.0 Hz to 108.0 Hz in 0.1 Hz step may be entered. Any frequency, other than the default setting of 90.0 Hz, will cause the VAL flag to enunciate.

**90 Hz %MOD**

Programs the modulation percentage of 90 Hz tone. This is a numeric field type and is programmable from 0 to 99% in 0.01% steps. The default for this field is 20%. The "VALUE LIMITED TO MAXIMUM" error is displayed if a 90 Hz modulation percentage causes the total modulation percentage, the sum of percent modulation of the 90 Hz, 150 Hz, and the ident tone, to exceed 99%. In this case, the system limits the 90 Hz modulation percentage to a value that forces all modulation percents to total 99%.

A current value for the DDM field will be computed and the field will be updated for the newly entered 90 Hz percent modulation data. If the sum of the 90 and 150 Hz percent modulation fields does not add to 40, the DDM field will display --- in the field and the modulation fields will be highlighted by an \* on both sides.

**150 Hz FREQUENCY**

Programs the 150 Hz frequency. A frequency from 120.0 Hz to 180.0 Hz in 0.1 Hz steps may be entered. Any frequency, other than the default setting of 150.0 Hz, will cause the VAL flag to enunciate.

**150 Hz %MOD**

Programs the modulation percentage for 150 Hz tone. This is a numeric field type and is programmable from 0 to 99% in 0.01% steps. The default for this field is 20%. The "VALUE LIMITED TO MAXIMUM" error will be displayed if the 150 Hz modulation percentage is set to a value which causes the total modulation to be more than 99%. In this case, the system limits the 150 Hz modulation field to a value that forces all modulation percents to total 99%.

A current value for the DDM field will be computed and the field will be updated for a newly entered 150 Hz percent modulation data. If the computed DDM exceeds .400, the DDM field will display --- in the field. Also, the LEFT/RIGHT field will be changed to reflect a newly entered percent of modulation field.

**1020 Hz FREQUENCY**

Programs the 1020 Hz frequency. A frequency from 10.0 Hz to 18000.0 Hz in 0.1 Hz steps may be entered. Any frequency, other than the default setting of 1020.0 Hz, will cause the VAL flag to enunciate.

**1020 Hz %MOD**

Programs the 1020 Hz tone modulation percentage. This is a numeric field type and is programmable from 0 to 99% in 0.01% steps. An entry of 0% modulation commands the NAV 2000R not to modulate the ident tone. The VAL flag will be set when any value, other than the default value of 20%, is entered.

The "VALUE LIMITED TO MAXIMUM" error will be displayed if a 1020 Hz modulation percentage causes the total modulation to be more than 99%. In this case, the system will limit the 1020 Hz modulation to a value that causes all modulation percents to total 99%. If a 90 or 150 Hz modulation percentage causes the total modulation percentage to exceed 99%, the system will adjust the desired 1020 Hz modulation percentage to realize a total modulation percentage of 99%.

**PHASE SHIFT**

Allows alteration of the phase between the 90 Hz and 150 Hz tones. The phase may be specified ranging from 0 to 359.99 degrees in 0.01 degree steps. Any phase shift value, other than the default setting of 0 degrees, will cause the VAL flag to enunciate.



## **IDENT MODE**

The ident mode field selects the identification tone modulation method. This is a toggle field containing three valid options: OFF, CODE, and TONE. A selection of OFF, the default setting, commands the unit to force the percent of modulation to 0%. Selecting CODE, causes the unit to Morse code modulate the specified identification string. And a selection of TONE, commands the NAV 2000R to modulate a 1020 Hz tone.

### **PAGE 3:**

## **IDENT CODE**

Allows modification to the identification string transmitted. The field uses the alphanumeric field entry. The characters allowed in the string are 0-9, A-Z, and the space. Characters lengths of 1 to 6 are allowed. The default for this field is the string "JCAIR".

## **WORD RATE**

Allows programming of time between each identification word. The valid range for the field is from 1 to 65 seconds programmable in 0.1 second steps. The default setting is 30 seconds.

## **DOT TIME**

Allows programming of Morse code dot time in milliseconds. The valid range is from 50 ms to 250 ms in 1 ms steps. The default value is 150 ms.

## **DASH TIME**

Allows programming of Morse code dash time in milliseconds. The valid range is from 150 ms to 750 ms in 1 ms steps. The default setting is 450 ms.

## **SPACING DOT/DASH**

Allows programming of delay time between Morse code dots and dashes. The valid range is from 150 ms to 750 ms in 1 ms steps. The default setting is 450 ms.

## **SPACING CHARACTER**

Allows programming of delay time between Morse code characters. The valid range is from 50 ms to 250 ms in 1 ms steps. The default setting is 150 ms.

### **3.5.8 LOC AUDIO CONTROL MODE (LOCa) FIELD DEFINITION**

The Localizer audio control mode, LOCa, is entered by pressing and releasing the SEL key while the AUDIO control mode field, LOC page 1, is selected. This mode allows the user to specify the NAV 2000R audio output signal level using volts RMS. No RF level control is allowed while within this mode of control.

#### **COMPOSITE AUDIO CONTROL:**

##### **AUDIO LEVEL**

This field allows the audio signal level to be changed. The value entered represents  $V_{rms}$  of the Localizer composite signal with both 90 and 150 Hz signals selected on, and a DDM setting of 0 DDM.

## **DDM**

Programs the modulation percentage of the 90 and 150 Hz tones. The valid entry range for this field is from .000 to .400 DDM (Difference in Depth of Modulation) in .001 steps. The NAV 2000R computes the percent of modulation ratio between the 90 and 150 Hz tones required to produce the commanded DDM.

When a valid Localizer DDM "hot" key is pressed the DDM will automatically be accepted. If a G/S DDM "hot" key is pressed, the system will accept it and will display, momentarily on the prompt line, the warning message: "NON-STANDARD DDM VALUE". Pressing the 90 or 150 Hz "hot" key will alternately shut off or turn on that tone to allow quick testing of a drop out of either tone at preset DDMs.

## **LEFT/RIGHT**

Specifies whether the Localizer reference is either LEFT/150 or RIGHT/90. When this toggle type field is selected, the current 90 and 150 Hz modulation percent data fields are switched. The default value is LEFT/150.

## **90 Hz MOD**

Specifies whether the 90 Hz signal is to be modulated. The field toggles between ON and OFF whenever the SEL key is pressed while the field is selected. The 90 Hz hot key will also toggle the current 90 Hz modulation state.

## **150 Hz MOD**

Specifies whether the 150 Hz signal is to be modulated. The field toggles between ON and OFF whenever the SEL key is pressed while the field is selected. The 150 Hz hot key will also toggle the current 150 Hz modulation state.

### **3.5.9 GLIDESLOPE MODE FIELD DEFINITION**

Glideslope test mode is entered by pressing and releasing the LOC/GS mode select button. This mode is used to test and align the Glideslope portion of ILS equipment.

#### **PAGE 1:**

#### **RF LEVEL**

This field allows the RF level to be programmed. The RF level may be programmed with 1/10th dBm resolution using either dBm or uV/mV units. DBm numbers are entered using the ENT key. Microvolts and millivolt numbers may be entered using the uV and mV keys (STO/RCL) respectively. The default displayed units (normally dBm) may be changed by pressing the SEL key and then pressing either the uV, mV, or dBm keys.

## **DDM**

Programs the modulation percentage of the 90 and 150 Hz tones. The valid range for this field is from .000 to .800 DDM in .001 steps. The NAV 2000R computes the percent of modulation ratio between the 90 and 150 Hz tones required to produce the commanded DDM. The modulation percentage of each tone will be set to the proper ratio and with both tones totaling the standard modulation of 80%. The default value for this field is .000 DDM, 40% modulation each.

Valid Glideslope DDM "HOT" keys will automatically set the DDM value in the DDM field. This is true even if the DDM field is not currently selected. If an invalid Glideslope DDM hot key is pressed, the system will display, momentarily on the prompt line, the warning message; "NON-STANDARD DDM VALUE".

## **UP/DOWN**

Specifies whether the Glideslope reference is either UP/150 or DOWN/90. This is a discrete toggle field type and the default setting is UP/150.

## **FREQ. MHz**

This field allows the RF frequency to be programmed. The RF frequency may be programmed in 0.00001 MHz steps within the NAV 2000R frequency range of 0.15 MHz to 450 MHz.

## **ILS PAIR**

An alternative field is selected by means of the +/- (ILS) button, while the FREQ MHz field is highlighted. This field allows the paired ILS frequency to be used to change the actual Glideslope frequency being generated. With the ILS PAIR window displayed, only paired frequencies of 108.1 to 111.95 preassigned for ILS operation may be selected. A listing of these preassigned frequencies may be displayed by pressing the RCL button followed by the LOC/GS button. The ENT button will return the user to the previous display. Pressing the SEL button with the ILS PAIR field highlighted will cause the CHANNEL field to be selected. The up and down arrow keys will then cause the ILS PAIR frequency selection to step through preassigned ILS frequency pairing.

## **CHANNEL**

This field steps the RF frequency output up and down by using the cursor control up and down arrow keys. With FREQ MHz window displayed, the output frequency will "STEP" up or down as selected by 150 KHz steps. With ILS PAIR window displayed, the output frequency will step up or down through the preassigned ILS paired frequency.

## **TOTAL %MOD**

This field allows changing all the percent modulation fields respective to one another. That is, changing the total percent modulation will allow all current modulations to be changed equally, maintaining the ratios between one another.

## **PAGE 2:**

### **90 Hz FREQ**

This field programs the 90 Hz frequency. A frequency from 72.0 Hz to 108.0 Hz in 0.1 Hz steps may be entered. Any frequency other than the default setting of 90.0 Hz will cause the VAL flag to enunciate.

### **90 Hz %MOD**

This field programs the modulation percentage of the 90 Hz tone. This is a numeric field type and is programmable from 0 to 99% in 0.01% steps. The default for this field is 40%. The "VALUE LIMITED TO MAXIMUM" error will be displayed if the entered 90 Hz modulation percentage causes the total modulation to be more than 99%. In this case, the system limits the 90 Hz modulation percentage such that total modulation percentage is 99%.

A current value for the DDM field will be computed and the field will be updated for a newly entered 90 Hz modulation percentage. If the computed DDM exceeds .800, the DDM field displays --- in the field. Also, the UP/DOWN field will be changed to reflect the newly entered modulation percentage.

### **150 Hz FREQ**

This field programs the 150 Hz frequency. A frequency from 120.0 Hz to 180.0 Hz in 0.1 Hz steps may be entered. Any frequency other than the default setting of 150.0 Hz will cause the VAL flag to enunciate.

### **150 Hz %MOD**

This field programs the desired percent of modulation of the 150 Hz tone. This is a numeric field type and is programmable from 0 to 99% in 0.01% steps. The default for this field is 40%. The "VALUE LIMITED TO MAXIMUM" error will be displayed if the entered 150 Hz modulation percentage causes the total modulation to exceed 99%. In this case, the system limits the 150 Hz modulation percentage so that the total modulation percentage is 99%.

A current value for the DDM field will be computed and the field will be updated for a newly entered 150 Hz modulation percentage. If the computed DDM exceeds .800, the DDM field will display --- in the field. Also, the UP/DOWN field will be changed to reflect the newly entered modulation percentage.

### **PHASE SHIFT**

Alters the phase between 90 and 150 Hz tones. A phase may be specified ranging from 0 to 359.99 degrees in 0.01 degree steps. Any phase shift value other than the default setting of 0 degrees will cause the VAL flag to enunciate.

## **3.5.10 ADF MODE FIELD DEFINITION**

ADF test mode is entered by pressing and releasing the ADF mode button. This mode is used to test and align ADF receivers. The ADF mode parameter fields are described in this section.

### **PAGE 1:**

#### **RF LEVEL**

This field allows the RF level to be programmed. The RF level may be programmed with 1/10th dBm resolution using either dBm or uV/mV units. Dbm numbers are entered using the ENT key. Microvolt and millivolt numbers are entered using the uV and mV keys (STO/RCL) respectively. The default display units (normally dBm) may be changed by pressing the SEL key and then pressing either the uV, mV or dBm keys.

#### **FREQ. MHZ**

This field allows the RF frequency to be programmed. The RF frequency may be programmed in 0.00001 Mhz steps within the NAV 2000R frequency range of 0.15000 mhz to 450.00000 mhz.

## **CHANNEL**

This field steps the RF frequency output up and down in 500 Hz steps using the cursor control up and down arrow keys.

## **TOTAL %MOD**

This field allows changing all the percent modulation fields respective to one another. That is, changing the total percent modulation will allow all current modulations to be changed equally, maintaining the ratios between one another. For example, suppose the 30 Hz modulation is set to 30%, 9960 Hz modulation is set to 20% and the ident tone 1000 Hz modulation is set to 10%. This indicates a total sum of 60%. If the total percent modulation was changed for 30% to 30%, the new component percent modulations would be 15%, 10% and 5% respectively.

## **tone freq**

Programs the 1000 Hz frequency. The user may specify a frequency from 10.0 Hz to 18000.0 Hz with 0.1 Hz step resolution.

## **MODULATION**

Programs the desired 1000 Hz tone percent of modulation. This is a numeric field type and is programmable from 0 to 99% in 0.01% steps. The "VALUE LIMITED TO MAXIMUM" error will be displayed if the user tries to enter a percent modulation value greater than 99%.

## **IDENT MODE**

Allows the user to specify how the identification tone is to be modulated. This is a toggle type field containing three valid options: OFF, CODE AND TONE. A selection of OFF, the default setting, commands the NAV 2000R to force the percent of modulation to 0%. A selection of CODE, causes the NAV 2000R to generate the specified Morse Code identification string using audio ON/OFF keying. A selection of TONE, commands the NAV 2000R to modulate a steady tone.

## **PAGE 2:**

## **IDENT CODE**

The identification field contains the identification string transmitted. The field uses the alphanumeric field entry method. The characters allowed in the string are 0 - 9 or A - Z. The maximum number of characters allowed is six. The default for this field is the ASCII string "JCAIR". The "space" character may be entered either at the beginning or end to allow entry of character strings shorter than six.

## **WORD RATE**

Allows the programming of the repetition rate at which the Morse Code identifier is transmitted. The valid range for the field is from 1 to 65 seconds programmable with 0.1 second step resolution. The default setting is 30 seconds.

## **DOT TIME**

Allows programming of the Morse Code dot time in milliseconds. The valid range is from 50 ms to 250 ms with 1 ms resolution. The default value is 150 ms.

### **DASH TIME**

Allows programming of the Morse Code dash time in milliseconds. The valid range is from 150 ms to 750 ms with 1 ms resolution. The default setting is 450 ms.

### **SPACING DOT/DASH**

Programs delay time between dots and dashes within Morse Code characters. The valid range is from 50 ms to 250 ms with 1 ms resolution. The default setting is 150 ms.

### **SPACING CHARACTER**

Programs delay time between Morse Code characters. The valid range is from 150 ms to 750 ms with 1 ms resolution. The default setting is 450 ms.

## **3.5.11 MARKER BEACON MODE FIELD DEFINITION**

The Marker Beacon mode is entered by pressing and releasing the MKR mode select button. This mode is used to test and align Marker Beacon equipment by modulating one user specified tone and simulating one of three Marker Beacons: inner, middle, or outer. The user may change the frequency and modulation and also may specify either a constant or pulsed mode of modulation. If the user selects CODE, the system will pulse the Marker Beacon modulation, on and off, at a rate defined by the beacon selected.

### **RF LEVEL**

This field allows the RF level to be programmed. The RF level may be programmed with 1/10th dBm resolution using either dBm or uV/mV units. DBm numbers are entered using the ENT key. Microvolts and millivolt numbers may be entered using the uV and mV keys (STO/RCL) respectively. The default displayed units (normally dBm) may be changed by pressing the SEL key and then pressing either the uV, mV, or dBm keys.

### **STONE FREQ.**

This field sets the Marker Beacon modulation frequency and allows changes to valid entry ranges within each of the three Beacon simulations. The Beacon frequency range may be reprogrammed to any value ranging from 10.0 Hz to 18000.0 Hz in 0.1 Hz steps. The outer Beacon frequency default setting is 400 Hz, middle Beacon 1300 Hz., and the inner Beacon is 3000 Hz. Any frequency, other than the Marker Beacon's default setting, will cause the VAL flag to enunciate.

### **BEACON MODE**

This field specifies which Marker Beacon type to simulate and is a discrete toggle type field with three available selections: OUTER, MIDDLE, and INNER. The default for this value is OUTER.

### **FREQ. MHz**

This field allows the RF frequency to be programmed.

### **MODULATION**

This field programs Marker Beacon modulation percentage. Only one Marker Beacon frequency is modulated at a time. This is a numeric field type and is programmable from 0 to 99.0% in 0.01% steps.

## **IDENT MODE**

This toggle menu selects the Marker Beacon modulation technique: OFF, TONE, CODE. When the default option of CODE is selected, the NAV 2000R will pulse the modulation on and off at a rate as defined by the Beacon selected. If TONE is selected, the NAV 2000R will modulate a constant marker beacon tone. If OFF is selected, the tone will not be modulated.

### **3.5.12 COMMUNICATION MODE FIELD DEFINITION**

The Communication mode is entered by pressing and releasing the COM mode button. This mode allows testing of communication equipment by modulating one or two tones simultaneously. The user may specify the frequency and modulation percentage of both tones. The sum of the tones is limited to 99% modulation.

#### **RF LEVEL**

This field allows the RF level to be programmed. The RF level may be programmed with 1/10th dBm resolution using either dBm or uV/mV units. DBm numbers are entered using the ENT key. Microvolts and millivolt numbers may be entered using the uV and mV keys (STO/RCL) respectively. The default displayed units (normally dBm) may be changed by pressing the SEL key and then pressing either the uV, mV, or dBm keys.

#### **FREQ. MHz**

This field allows the RF frequency to be programmed.

#### **CHANNEL**

This field steps the RF frequency output up and down by using the cursor control up and down arrow keys.

#### **tone #1 FREQUENCY**

This field is used to program the first tone frequency from 10.0 Hz to 18000.0 Hz in 0.1 Hz steps. The default for this field is 1000 Hz.

#### **tone #1 MODULATION**

This field programs the modulation percentage of the first tone. This is a numeric entry field type and is programmable from 0 to 99% in 0.01% steps. The default value for this field is 30%. The sum of the modulated tones will be limited to be no more than 99%.

#### **tone #2 FREQUENCY**

This field is used to program the second tone frequency from 10.0 Hz to 18000.0 Hz in 0.1 Hz steps. The default for this field is 2000 Hz.

#### **tone #2 MODULATION**

This field programs the modulation percentage for the second tone. This is a numeric entry field type and is programmable from 0 to 99% in 0.01% steps. The default setting is 0% modulation. The sum of the modulated tones will be limited to no more than 99%.

## **TOTAL %MOD**

This field allows changing all the percent modulation fields respective to one another. That is, changing the total percent modulation will allow all current modulations to be changed equally, maintaining the ratios between one another.

## **SELECT**

Selecting the SELECT mode field places the NAV 2000R into the SELCAL mode of operation. The SELCAL mode menus are described in Section 3.5.13.

### **3.5.13 SELCAL MODE**

The SELCAL mode allows the NAV 2000R to output the signals necessary to test SELECTIVE CALLING. The SELCAL mode menus allow programming of the RF and audio signals.

#### **PAGE 1:**

##### **RF LEVEL**

This field allows the RF level to be programmed. The RF level may be programmed with 1/10th dBm resolution using either dBm or uV/mV units. DBm numbers are entered using the ENT key. Microvolts and millivolt numbers may be entered using the uV and mV keys (STO/RCL) respectively. The default displayed units (normally dBm) may be changed by pressing the SEL key and then pressing either the uV, mV, or dBm keys.

##### **FREQ. MHz**

This field allows the RF frequency to be programmed.

##### **CHANNEL**

This field steps the RF frequency output up and down by using the cursor control up and down arrow keys.

##### **RF KEY**

This toggle field allows the RF frequency to be turned "ON" or "OFF". When this selection is turned on, the Selective Calling sequence is initiated.

##### **PULSE MOD**

This field programs the modulation percentage for the pulse tones. This is a numeric entry field type and is programmable from 0 to 99% in 0.01% steps. The default setting is 0% modulation. The sum of the modulated tones will be limited to be no more than 99%.

##### **INITIATE**

This toggle field allows the SELCAL mode to be made "ACTIVE" or "INACTIVE". When this selection is made ACTIVE, the Selective Calling sequence is initiated. When the RF KEY field is OFF, turning this selection to the ACTIVE state causes the RF output to RISE to the selected preset level, the SELCAL tone pairs to be sent, and then the RF OUTPUT to RETURN OFF. Activation of the INITIATE FIELD, with RF ON simply causes the SELCAL tone pairs to be sent.



## **TONE DIFF**

This field programs the tone amplitude difference of Pulse #1 to Pulse #2. This is a numeric entry field type and is programmable from -40 to +40 dB in 1 dB steps. The default setting is 0 dB.

## **PAGE 2:**

### **PULSE #1 CODE**

Allows modification to the PULSE #1 TONE #1 and TONE #2 frequencies. The field uses the alphanumeric field entry. The two characters in the field must fall within the range A-S. The default for this field is the string "AB". These characters correspond to the frequency displayed in the PULSE #1 TONE #1 and PULSE #1 TONE #2 bubbles.

### **PULSE #1 TONE #1**

This field is used to program the first tone frequency, in pulse number one. The frequency shown here corresponds to the code entered into the PULSE #1 CODE bubble (first character). This numeric data field may be edited to produce non-standard frequencies.

### **PULSE #1 TONE #2**

This field is used to program the second tone frequency, in pulse number one. The frequency shown here corresponds to the code entered into the PULSE #1 CODE bubble (second character). This numeric data field may be edited to produce non-standard frequencies.

### **PULSE #2 CODE**

Allows modification to the PULSE #2 TONE #1 and TONE #2 frequencies. The field uses the alphanumeric field entry. The two characters in the field must fall within the range A-S. The default for this field is the string "CD". These characters correspond to the frequency displayed in the PULSE #2 TONE #1 and PULSE #2 TONE #2 bubbles.

### **PULSE #2 TONE #1**

This field is used to program the first tone frequency, in pulse number two. The frequency shown here corresponds to the code entered into the PULSE #2 CODE bubble (first character). This numeric data field may be edited to produce non-standard frequencies.

### **PULSE #2 TONE #2**

This field is used to program the second tone frequency, in pulse number two. The frequency shown here corresponds to the code entered into the PULSE #2 CODE bubble (second character). This numeric data field may be edited to produce non-standard frequencies.

### **COM TEST TONE FREQUENCY**

This field is used to program the COMM test tone frequency from 10.0 Hz to 18000.0 Hz in 0.1 Hz steps. The default for this field is 1000 Hz.

### **COM TEST TONE MODULATION**

This field programs the modulation percentage of the COM test tone. This is a numeric entry field type and is programmable from 0 to 99% in 0.01% steps. The default for this field is 30%.

**PAGE 3:**

**PULSE #1 TIME**

Allows programming the width of pulse number one. The valid range is from 0 to 2 seconds in 1 ms steps. The default for this field is 1 second.

**GAP TIME**

Allows programming the gap between pulse number one and pulse number two. The valid range is from 0 ms to 999 ms in 1 ms steps. The default for this field is 500 ms.

**PULSE #2 TIME**

Allows programming the width of pulse number two. The valid range is from 0 to 2 seconds in 1 ms steps. The default for this field is 1 second.

**3.5.14 UTILITY MENU**

The utility menu allows access to 7 utilities which are listed below. Note that option 2, SELECT EXT. MODULATION MODE, and option 4, SELECT CALIBRATION MODE, provide access to two additional operational modes. The EMM mode is described in Section 3.5.15 and the CAL mode in Section 3.5.16. The utility menu options are discussed in this section.

- 0 | EXIT UTILITY MENU
- 1 | DISPLAY/MODIFY GPIB ADDRESS
- 2 | SELECT EXT. MODULATION MODE
- 3 | SET EXT. MOD. RELAY (On/Off)
- 4 | SELECT CALIBRATION MODE
- 5 | DISPLAY SYSTEM STATUS
- 6 | EXECUTE DISPLAY TEST
- 7 | SET ALL REGISTERS TO DEFAULT

**EXIT UTILITY MENU**

Selecting this Utility menu option returns the NAV 2000R to the mode which was the current mode upon entry into the Utility menu.

**DISPLAY/MODIFY GPIB ADDRESS**

This option permits the user to display and modify the current NAV 2000R GPIB address. The address field specifies the desired GPIB address of the NAV 2000R for talk and listen. This is the address the NAV 2000R responds to during a host computer call for talk or listen bus transactions. This field is a numeric data type and has a valid range from 0 to 31. The default address value is 20.

**SELECT EXT. MODULATION MODE**

This option enables external modulation. The external modulation is applied to the RF module external modulation input. When external modulation is selected, all internal modulation is removed. External Modulation Mode is discussed in detail in Section 3.5.15.

**SET EXT. MOD. RELAY (On/Off)**

This option enables the external modulation input to be switched on or off. "ON" allows audio applied to the external modulation input to be summed with internally generated audio. The percent modulation, selected during the mode of operation in use, is referenced to internally generated audio only. External audio will add additional depth to the modulation. "ON" will be identified by a flashing "EM" on the status line.

**CALIBRATION MODE**

The calibration mode places the NAV 2000R into a mode that guides the test/calibration user through the calibration and alignment steps of the NAV 2000R. The calibration mode is covered in detail in Section 3.5.16.

**DISPLAY SYSTEM STATUS**

This option displays the power on self-test results and the current operational status of the NAV 2000R. It can be used to ensure proper operation of the NAV 2000R.

**SYSTEM STATUS**

<p><b>GENERAL</b>                  MODE: VOR                    OPERATION: LOCAL                    GPIB ADDRESS: 20                    MODULATE: INTERNAL                    ON TIME: 3.3 HRS                    CYCLES: 15</p>	<p><b>CPU</b>                  VERSION: 1.00    <b>ROM</b> UV BOOT: OK                  DYNAMIC: OK    <b>RAM</b> STATIC: OK                  BATTERY: OK</p> <hr/> <p><b>DSP</b>                    VERSION: 1.01                  BUS RESPONSE?: YES                  PROGRAM BOOT?: YES                  SINE ROM OK?: YES</p>
<p><b>RF SOURCE</b>                    VERSION: 1.00                  BUS RESPONSE?: YES                  RF LEVEL: OK                  RF FREQUENCY: OK</p>	<p><b>MODULATOR</b>                    BUS RESPONSE?: YES                  AUDIO LEVEL: OK                  DETECT AUDIO: OK                  RF LEVEL: OK</p>

\*\*\* PRESS ENT KEY TO CONTINUE \*\*\*

The above is a typical STATUS screen. A brief description of the screen follows.

Under the GENERAL heading are; MODE: indicates current selected mode, OPERATION: LOCAL or REMOTE operation is selected, GPIB ADDRESS: selected GPIB address, MODULATE: indicates whether EXTERNAL audio, INTERNAL audio, or both is applied to the NAV 2000R modulator, ON TIME: indicates total time that the NAV 2000R has been powered on, in hours since manufacture, CYCLES: indicates the number of times that the NAV 2000R has been switched on.

Under the CPU heading are; VERSION: indicates software version number of the CPU board, ROM: indicates results of the UV BOOT ROM and DYNAMIC EPROM self tests, RAM: indicates results of the STATIC RAM and Battery RAM self tests.

Under the DSP headings are; VERSION: indicates software version number of DSP software, BUS RESPONSE?: indicates proper operation of DSP board bus interface, PROGRAM BOOT?: indicates results of the self test of DSP boot RAM, SINE ROM OK?: indicates results of the self test of DSP ROMS.

Under the RF SOURCE heading are; VERSION: indicates software version number of the internal RF generator software, BUS RESPONSE?: indicates proper operation of FREQ GEN bus interface, RF LEVEL: indicates whether RF LEVELING circuits are within limits, RF FREQUENCY: indicates frequency control loops operation.

Under the MODULATOR heading are; BUS RESPONSE?: indicates proper operation of MODULATOR bus interface, AUDIO LEVEL: indicates the current level of audio at the modulator input, DETECT AUDIO: indicates detected audio check during self-test passed or failed, RF LEVEL: indicates RF output level is being controlled.

#### **EXECUTE DISPLAY TEST**

This option allows a visual test of the display. The test turns on all of the display's pixels. A message, "PRESS KEY TO STOP", is moved around in the display in random places. Observe the display to determine if all of the pixels turn off and on properly. Then press any key to terminate the display test.

#### **SET ALL REGISTERS TO DEFAULT**

Sets all saved registers information and current field data selections to default factory settings.

### **3.5.15 EXTERNAL MODULATION MODE**

External Modulation Mode (EMM) allows an external modulating signal to modulate the RF input. It is accessed through the Utility Menu by depressing a Mode control key for two seconds and then choosing option 2 from the Utility Menu. The External Modulation is AC coupled and is applied to the EXT MOD IN port on the rear panel of the RF Modulator Module. The EMM menu shows external audio level high, low, or O.K. depending upon whether or not the peak of the audio signal is set appropriately. The level of an audio signal applied to the external modulation input is nominally 1 volt peak.

### **3.5.16 CALIBRATION MODE**

The calibration mode of operation will aid the user in the calibration and alignment of the NAV 2000R unit. To calibrate the NAV 2000R, follow the instructions found on these pages. Additionally, the user should refer to the calibration procedure contained within this manual. This procedure furnishes more detailed test equipment setup instructions and should be used as the primary procedure. The pages displayed within the CALIBRATION mode are useful as aids and when selected, automatically sets NAV 2000R inputs and outputs to the required state for the alignment being made. Upon completion of each page of instruction press the "ENT" key. If an adjustment is to be skipped, pressing the 120 degree Bearing hot key will select the next page and therefore, setup conditions for that step of alignment.

### **3.5.17 DISPLAY DEFINITION DURING POWER ON SEQUENCE**

This section defines the display definition during the NAV 2000R power-up sequence. During power-up, the NAV 2000R initializes the display screen and displays the JCAIR symbol and "NAV 2000R" using large sized characters while it executes a self-test diagnostic. The diagnostic test results will be displayed under the heading "SYSTEM DIAGNOSTICS....." as the self-test proceeds. If all self-tests are passed, a second screen will display. If any self-test fails, the fail test flashes, as a notification to the operator. After a failed self-test, the operator must press the ENT key for the unit to proceed. On the second screen, which remains for approximately seven seconds, the current software version status of both the CPU and DSP boards is displayed. Following this screen, the NAV 2000R will enter normal operation, as defined by the unit configuration.

### **3.5.18 STORING & RECALLING SETUPS**

The NAV 2000R has the ability to store and recall up to 49 different NAV 2000R conditions. All NAV 2000R selection options are stored to memory for later recall. The store function saves current NAV 2000R status, configuration setup, system mode of operation, field data, and the current page and field selector positions.

This means that all entries of the six primary modes: VOR, LOC, G/S, ADF, MKR, and COM, and the secondary modes: EMM, VORa, and LOCa are stored.

Current NAV 2000R conditions are stored by pressing and releasing the store, STO, key (while not field editing or entering). A pop up menu prompts for storage register number. The storage register number is entered using the numeric keypad and is a number from 1 to 49.

Previously saved NAV 2000R test setups are recalled by pressing the RCL key. A pop up menu prompts for the storage register number. The storage register number is entered using the numeric keypad and is a number from 1 to 49.

Following a recall, the NAV 2000R will remain in its current SELECTED MODE with the stored field data updating the previous setup. Selection of a different mode will then select that selected mode's recalled field data. Therefore, nine test setups, one of each operating mode, are stored and recalled for each register number.

If a setup is stored or recalled, this will continue to be displayed on the status line until a field is modified.

Recalling register 00 sets all NAV 2000R fields to factory default settings. Storage to register 00 is not possible.

Also, if the LOC/GS mode button is pressed while the recall "pop up" window is displayed, an ILS frequency pairings help screen will appear.

## **3.6 REMOTE USER INTERFACE**

This section defines the NAV 2000R remote interface. The NAV 2000R achieves remote control via the GPIB.

### 3.6.1 GPIB REMOTE INTERFACE DESCRIPTION

The NAV 2000R will buffer incoming command characters until the GPIB controlling host signals an EOI (end of string) interrupt with the last data character. The NAV 2000R is capable of handling up to 4096 command characters at one time. If an incoming command string exceeds the 4096 byte mark, which primarily occurs with binary downloads, the NAV 2000R will truncate extra characters.

A maximum of 511 bytes of characters can be returned by the NAV 2000R at once. At present, all GPIB commands return only a few bytes of information. Therefore, 32 bytes are sufficient.

GPIB commands sent to the NAV 2000R are not case sensitive. That is, both lower and upper case characters are treated the same. Any "white space" characters are ignored, allowing the space character to be used freely to promote readability. The <CR> carriage return and <LF> line feed characters are treated as "white space" characters and are ignored.

All commands may be compounded by using the semicolon ';' character to separate each individual command. This allows the controller's application to send several setup commands at once if desired. However, if the controller requests the NAV 2000R to return multiple information, the last requested information will be the only data available.

After the GPIB controller sends a command string to the NAV 2000R, it may request a response from the NAV 2000R at anytime. A list of the returned data for the given conditions are as follows:

- 1> If the last command sent was unrecognizable, the NAV 2000R will return the character '?'.
- 2> If the last command sent was recognized and, by definition, returns a value, that value will be returned by the NAV 2000R.
- 3> If a recognized command does not, by definition, return a value, the character '\*' will be returned.
- 4> The '#' character is returned when a recognized command contains invalid parametric data (in the form of arguments). The parametric data may be unrecognizable or may just be out of range.
- 5> The '!' character is returned when a recognized command received is illegal for the current given NAV 2000R mode of operation.
- 6> The '%' character is returned if a NAV 2000R fatal error is in existence. This can occur with power up self test failures of major NAV 2000R internal systems.

If a command in the middle of a compound command string causes an error, ('?', '#', '!', '%' types), remaining commands within the command string will be ignored to allow notification to the controller that it's application has an unwanted condition present. This occurs during application debug stages due to syntax type errors.

### 3.6.2 COMMAND LIST

This Section contains the NAV 2000R command list. Each command is described using the following method:

- 1> Values to/from the NAV 2000R are denoted with the following letters:
  - D Decimal characters; 0 - 9
  - H Hexadecimal digits; 0 - 9, A - F
  - A ASCII Alpha-Numeric characters; 0 - 9, A - Z
- 2> Letters surrounded with parenthesis indicate values that are returned from the NAV 2000R.
- 3> Letters not surrounded by parenthesis indicate command argument values.
- 4> Characters surrounded with box braces (['']) indicate optional items from the user or characters that the NAV 2000R may possibly return.

COMMAND: RETURN SYSTEM STATUS

FORMAT: **STAT?** (HHHHHHHH)

\_\_\_\_\_Least significant nibble

The STAT? command returns NAV 2000R's current system status word. Bits within this word indicate certain system conditions. A logic one (1) in the defined bits of the binary conversion of the hexadecimal number indicate:

- BIT 0: Fatal error exists (Use FERR? for type)
- BIT 1: HOST CPU operating from boot memory. NAV 2000R Operating software not running
- BIT 2: Remote only operation selected
- BIT 3: User edit occurring
- BIT 4: External modulation audio is summed with internal audio
- BIT 5: Not defined
- BIT 6: VAL annunciator, Non standard value defined
- BIT 7: Not defined
- BIT 8: RF level is too high
- BIT 9: RF level is too low
- BIT 10: Modulation audio is too high for indicated modulation
- BIT 11: Modulation audio is too low for indicated modulation
- BIT 12: Detected RF is too high for 50% modulation peak
- BIT 13: Detected RF is too low for 50% modulation peak
- BIT 14: RF Modulator communication error detected
- BIT 15: Power ON self-test is in progress
- BIT 16: GEN #1 Invalid RF frequency
- BIT 17: GEN #1 RF
- BIT 18: GEN #1 VCO1 is unlocked
- BIT 19: GEN #1 VCO2 is unlocked
- BIT 20: GEN #1 Self-test error detected
- BIT 21: Not defined
- BIT 22: Not defined
- BIT 23: Not defined
- BIT 24: Reserved spare
- BIT 25: Reserved spare
- BIT 26: Reserved spare
- BIT 27: Reserved spare
- BIT 28: Reserved spare
- BIT 29: Not defined
- BIT 30: Not defined
- BIT 31: Not defined

COMMAND: SET SYSTEM MODE OF OPERATION  
 FORMAT: **MODE= AAAAA**

The MODE= command sets the NAV 2000R mode of operation. It is equivalent to pressing the front panel mode select keys. The ASCII argument specified will determine the mode to be set. The valid modes of operation selectable remotely are: VOR, VORa, LOC, LOCa, G/S, MKR, COM [M], and EMM.

COMMAND: RETURN CURRENT SYSTEM MODE OF OPERATION  
 FORMAT: **MODE? (AAAAAA)**

The MODE? command returns the present NAV 2000R mode of operation. The operational mode is returned using an ASCII string of characters. The system may return; VOR, VORa, LOC, LOCa, G/S, MKR, COM, EMM, CAL, or TEST.

COMMAND: RETURN FATAL ERROR STATUS  
 FORMAT: **FERR? (HHHH)**  
                   |\_\_\_\_Least significant nibble

The FERR? command returns the NAV 2000R's fatal error status word. Bits within this word indicate certain fatal error conditions. A logic one (1) in the defined bits of the binary conversion of the hexadecimal number indicate:

- BIT 0: HOST ROM FAILURE
- BIT 1: HOST RAM FAILURE
- BIT 2: HOST FLASH EPROM FAILURE
- BIT 3: HOST SETUPS REGISTER FAILURE (BATTERY RAM)
- BIT 4: HOST NONVOLATILE RAM FAILURE (BATTERY RAM)
- BIT 5: Not defined
- BIT 6: Not defined
- BIT 7: Not defined
- BIT 8: DSP RAM FAILURE
- BIT 9: DSP BUS INTERFACE FAILURE
- BIT 10: DSP BOOT FAILURE
- BIT 11: DSP SINE LOOKUP ROM FAILURE
- BIT 12: MODULATOR BUS INTERFACE FAILURE
- BIT 13: RF GENERATOR #1 BUS INTERFACE FAILURE
- BIT 14: Not defined
- BIT 15: Not defined

COMMAND: RESET REVERSE POWER PROTECTION CIRCUIT  
 FORMAT: **RPP RESET**

The RPP RESET command resets the reverse power protection module if it has been tripped.

COMMAND: ENABLE FRONT PANEL CONTROL  
 FORMAT: **LOCAL**

Execution of the LOCAL command cancels REMOTE only operation. This re-enables user front panel control by unlocking the front panel keys. Remote commands are allowed during local operation of NAV 2000R. The system automatically forces remote operation with any command sent to the NAV 2000R.

COMMAND: SET ALL SETTINGS TO FACTORY DEFAULT VALUES  
 FORMAT: **DEFAULT**

The DEFAULT command forces the NAV 2000R to reset all data values to the default factory settings. All previously set data is lost upon execution of this command. Also EM<sup>Ⓜ</sup> is cleared.



COMMAND: SET RF POWER LEVEL  
FORMAT: **RF LEVEL= [+][-] DDD[.DDDDD] [units]**

This command sets the RF generator power level to the specified level in either dBm, uV, or mV units. The power units are specified following the data field. If a measure unit, either dBm, uV, or mV, is not specified, the NAV 2000R will default the data to be in dBm units. Range limits are checked to insure the user does not select a power level out of range for the selected mode of operation.

COMMAND: SET AUDIO OUTPUT LEVEL  
FORMAT: **AUDIO LEVEL= [D].DDD**

This command allows the adjustment of the audio output level specifying using Vrms with 0.001 Vrms resolution. This command is only valid with VORa and LOCa audio control modes. The range allowed is from 0 to 1.000 Vrms.

COMMAND: SET RF OUTPUT FREQUENCY  
FORMAT: **RF FREQ= [DDD].DDDDD**

This command allows the adjustment of the RF Generator output frequency using MHz with 0.00001 MHz resolution. The range allowed is from 0.150 to 450.000 MHz.

COMMAND: SET MARKER BEACON MODE  
FORMAT: **MKR MODE= AAAAA**

This command sets the current marker beacon mode of operation. The argument value must be any of the three: OUTER, MIDDLE or INNER. With the execution of this command, the NAV 2000R will automatically reset the marker frequency to the default value.

COMMAND: SET VOR BEARING  
FORMAT: **BEARING= DDD[.DD]**

The BEARING command sets the current VOR bearing. Values from 0 to 359.99 will be allowed.

COMMAND: SET DDM  
FORMAT: **DDM=.DDD**

The DDM set command allows the user to define the desired DDM value for Localizer and Glideslope modes of operation. Issuing a subsequent modulation percentage set command, for either the 90 Hz or 150 Hz modulation percentages, overrides this command.

COMMAND: SET VOR REFERENCE (TO/FROM)  
FORMAT: **VOR REF= AAAAA**

This command sets the current VOR reference as either being TO or FROM.

COMMAND: SET LOCALIZER REFERENCE (LEFT/RIGHT)  
FORMAT: **LOC REF= AAAAA**

This command sets the current Localizer DDM reference as either being LEFT or RIGHT. Issuing a subsequent modulation percentage set command, for either the 90 Hz or 150 Hz modulation percentages, overrides this command.

COMMAND: SET GLIDESLOPE REFERENCE (UP/DOWN)  
FORMAT: **G/S REF= AAAA**

This command sets the current Glideslope DDM reference as either being UP or DOWN. Issuing a subsequent modulation percentage set command, for either the 90 Hz or 150 Hz modulation percentages, overrides this command.

COMMAND: SET IDENTIFICATION MODE  
FORMAT: **IDENT MODE= AAAA**

This command selects whether the identification code is to be modulated either constant or Morse coded. The ASCII argument should be TONE for constant modulation, CODE for coded modulation, or OFF for no modulation. This command effects only VOR, LOC, ADF and MKR modes of operations.

COMMAND: SET IDENTIFICATION CODE  
FORMAT: **IDENT CODE= AAAAA**

This command sets the desired identification code for VOR, LOC and ADF modes. The number of ASCII characters allowed is six and any other characters will be truncated.

COMMAND: DOT TIME LENGTH  
FORMAT: **DOT TIME= DDD**

This command changes the period of time defining a Morse code DOT. Range is from 50 to 250 ms (1 ms steps).

COMMAND: DASH TIME LENGTH  
FORMAT: **DASH TIME= DDD**

This command changes the period of time defining a Morse code DASH. Range is from 150 to 750 ms (1ms steps).

COMMAND: DOT/DASH SPACING LENGTH  
FORMAT: **DOT DASH SPACE= DDD**

This command may be used to change the period of time defining Morse code spacing between DOTS and, or DASHES of a character. Length may vary from 50 to 250 ms in steps of 1 ms.

COMMAND: CHARACTER SPACING LENGTH  
FORMAT: **CHAR SPACE= DDD**

This command may be used to change the time defining Morse code spacing between characters. Length may vary between 150 and 750 ms in 1 ms steps.

COMMAND: IDENTIFICATION WORD RATE  
FORMAT: **WORD RATE= DD[.D]**

This command may be used to set the repetition rate at which the Morse Code identifier is transmitted. Rate may be programmed from 1.0 to 65.0 s. with 0.1 s. resolution.

COMMAND: IDENTIFICATION WORD DELAY  
 FORMAT: **WORD DELAY= DD[D]**

This command may be used to set the delay from the end of a Morse code identifier transmission to the beginning of the next transmission. Word rate as defined above is calculated. Time may be programmed to produce any word rate from 1.0 to 65.0 s. with 0.1 s. resolution.

COMMAND: SET 30 Hz FREQUENCY  
 FORMAT: **30 HZ= DD[D]**

This command changes the 30 Hz frequency. The 30 Hz signal is only generated during VOR mode. The argument value is specified in Hz with 0.1 Hz resolution.

COMMAND: SET 90 Hz FREQUENCY  
 FORMAT: **90 HZ= DD[D]**

This command deviates the 90 Hz frequency. The 90 Hz signal is only generated during the LOC and G/S modes. The argument value is specified in Hz with 0.1 Hz resolution.

COMMAND: SET 150 Hz FREQUENCY  
 FORMAT: **150 HZ= DD[D]**

This command deviates the 150 Hz frequency. The 150 Hz signal is only generated during the LOC and G/S modes. The argument value is specified in Hz with 0.1 Hz steps.

COMMAND: SET 90/150 Hz PHASE  
 FORMAT: **PHASE = DDD[.DD]**

This command deviates the 90 Hz and 150 Hz phase relationship. These signals are only generated during the LOC and G/S type modes. The argument value is specified in degrees with 0.01 degree resolution and may range from 0 to 359.99 degrees.

COMMAND: SET 9960 Hz FREQUENCY  
 FORMAT: **9960 HZ= DDDDD[D]**

This command deviates the 9960 Hz frequency. The 9960 Hz signal is only generated during the VOR modes. The argument value is specified in Hz with 0.1 Hz resolution. The valid frequency that may be specified may range from 9,000 to 12,000 Hz.

COMMAND: SET 1020 Hz FREQUENCY  
 FORMAT: **1020 HZ= DDDDD[D]**

This command allows the user to deviate the 1020 Hz identification frequency. The 1020 Hz signal is only generated during the VOR and LOC modes. The units are in Hz with 0.1 Hz resolution and may range from 10 to 18000 Hz.

COMMAND: SET MARKER BEACON FREQUENCY  
 FORMAT: **MKR FREQ= DDDDD[D]**

This command sets the marker beacon frequency to a specific value. This command must follow a marker beacon mode set command since marker beacon frequency is automatically set to be the default when the beacon mode changes.

COMMAND: SET COMMUNICATION FREQUENCY TONE #1  
 FORMAT: **COM FREQ1= DDDDD[.D]**

This command sets the desired communication tone #1's frequency. The communication frequency is specified in Hz using 0.1 Hz resolution and may range anywhere from 10 to 18,000.0 Hz.

COMMAND: SET COMMUNICATION FREQUENCY TONE #2  
 FORMAT: **COM FREQ2= DDDDD[.D]**

This command sets the desired communication tone #2's frequency. The communication frequency is in Hz with 0.1 Hz resolution. Its' setting may also range from 10 to 18,000 Hz.

COMMAND: SET ADF FREQUENCY  
 FORMAT: **ADF FREQ = DDDD[.D]**

This command sets the ADF tone frequency. This command is only valid during the ADF mode of operation. The programmable resolution is 0.1 Hz. The valid range is 10.0 Hz to 18000.0 Hz.

COMMAND: SET 30 Hz MODULATION PERCENTAGE  
 FORMAT: **30HZ %MOD= DD[.DD]**  
 FORMAT (VORa mode only): **30HZ %MOD= AAA**

This command sets the 30 Hz tone modulation percentage. The 30 Hz signal is produced only during the VOR modes of operation. During the VORa audio control mode, an ASCII string of "ON" or "OFF" must be specified. With normal VOR mode, a numeric value may be specified with 0.01 % resolution.

COMMAND: SET 90 Hz MODULATION PERCENTAGE  
 FORMAT: **90HZ %MOD= DD[.DD]**  
 FORMAT (LOCa mode only): **90HZ %MOD= AAA**

This command sets the 90 Hz modulation percentage. The 90 Hz signal is produced during LOC and G/S modes of operation. Setting the 90 Hz modulation percentage may cancel (or change) any previously DDM or DDM reference settings. During the LOCa audio control mode, an ASCII string of "ON" or "OFF" must be specified. With normalized modes, a numeric value may be specified with 0.01 % resolution.

COMMAND: SET 150 Hz MODULATION PERCENTAGE  
 FORMAT: **150HZ %MOD= DD[.DD]**  
 FORMAT (LOCa mode only): **150HZ %MOD= AAA**

This command sets the 150 Hz modulation percentage. The 150 Hz signal is produced during LOC and G/S modes of operation. Setting the 150 Hz modulation percentage may cancel (or change) any previously DDM or DDM reference settings. During the LOCa audio control mode, an ASCII string of "ON" or "OFF" must be specified. With normalized modes, a numeric value may be specified with 0.01 % resolution.

COMMAND: SET 9960 Hz MODULATION PERCENTAGE  
 FORMAT: **9960HZ %MOD= DD[.DD]**  
 FORMAT (VORa mode only): **9960HZ %MOD= AAA**

This command sets the 9960 Hz tone modulation percentage. The 9960 Hz signal is produced only during the VOR modes of operation. During the VORa audio control mode, an ASCII string of "ON" or "OFF" must be specified. With normal VOR mode, a numeric value may be specified with 0.01 % resolution.

COMMAND: SET 1020 Hz MODULATION PERCENTAGE  
FORMAT: **1020HZ %MOD= DD[.DD]**

This command sets the 1020 Hz modulation percentage and is produced only during VOR and LOC modes of operation. The resolution is 0.01 %.

COMMAND: SET MARKER BEACON MODULATION PERCENTAGE  
FORMAT: **MKR %MOD= DD[.DD]**

This command sets the marker beacon modulation percentage of tone #1. This marker beacon signal is produced only during the marker beacon mode of operation and has a program resolution of 0.01 %.

COMMAND: SET COMMUNICATION MODULATION % TONE #1  
FORMAT: **COM %MOD1= DD[.DD]**

This command sets the communication tone 1 signal modulation percentage. This command is only valid during the communications (COM) mode of operation. The programmable resolution is 0.01 percent.

COMMAND: SET COMMUNICATION MODULATION % TONE #2  
FORMAT: **COM %MOD2= DD[.DD]**

This command sets the communication tone 2 signal modulation percentage. This command is only valid during the communications (COM) mode of operation. The programmable resolution is 0.01 percent.

COMMAND: SET TOTAL PERCENT OF MODULATION  
FORMAT: **TOTAL %MOD= DD[.DD]**

This command allows the total percent of modulation to be programmed within the VOR, LOC, G/S, and COM modes of operation. This command changes all the percent mods. for a given mode equally. The total may range from 0 to 99.00 % and can be specified with 0.01 % resolution.

COMMAND: SET EXTERNAL MOD MODULATION %  
FORMAT: **EMM %MOD= DD[.DD]**

This command sets the modulation percentage of the external modulating signal. This value is used only in the external modulation mode (EMM) and represents the actual depth of modulation only with proper level applied to the external modulation input.

COMMAND: SET ADF MODULATION PERCENTAGE  
FORMAT: **ADF %MOD= DD[.DD]**

This command sets the ADF tone modulation percentage. This command is only valid during the ADF mode of operation. The programmable resolution is 0.01 percent. The valid range is 0.0% to 99.00%.

COMMAND: EXTERNAL MODULATION INPUT ON/OFF  
FORMAT: **EXT MOD= AAA**

This command either switches "ON" the external modulation input to be summed with internally generated audio, or switches the external modulation input "OFF".

COMMAND: RETURN SOFTWARE VERSION OF CPU BOARD  
FORMAT: **SVC? (A...A)**

This command requests the NAV 2000R to return the current CPU board software version number. The version is returned as an ASCII string.

COMMAND: RETURN SOFTWARE VERSION OF DSP BOARD  
FORMAT: **SVD? (A...A)**

This command requests the NAV 2000R to return the current DSP board software version number. The version is returned as an ASCII string.

COMMAND: RETURN SOFTWARE VERSION OF GENERATOR #1 BOARD  
FORMAT: **SVG? (A...A)**

This command requests the NAV 2000R to return the current GENERATOR #1 board software version number. The version is returned as an ASCII string.

COMMAND: SET SELECTIVE CALLING RF ON/OFF  
FORMAT: **SCL RF KEY= AAA**

This command switches "ON" or "OFF" the Selective Calling RF carrier. When this command is sent to the NAV 2000R, the two Selective Calling pulses are transmitted using the current settings. After transmission is complete the carrier remains on.

COMMAND: SET SELECTIVE CALLING ACTIVE/INACTIVE  
FORMAT: **SCL INIT= AAAAAAAAA**

This command initiates the transmission of the two Selective Calling pulses, using the current settings, when "ACTIVE" is in the data field. When "INACTIVE" is in the data field, the transmission of the two Selective Calling pulses is stopped, however the RF carrier remains on.

**NOTE:** If the NAV 2000R's RF carrier has not been turned on prior to sending this command, no action is performed. The RF carrier can be turned on in two ways: by sending the SCL RF KEY= ON command, or by using the SELCAL menus while the NAV 2000R is in Local mode.

COMMAND: SET PULSE PERCENT OF MODULATION  
FORMAT: **SCL %MOD= DD[.DD]**

This command allows the percent of modulation to be programmed for the pulses in the Selective Calling mode of operation. The total may range from 0 to 99.00 % and can be specified with 0.01 % resolution.

COMMAND: SET TONE AMPLITUDE DIFFERENCE  
FORMAT: **SCL DIFF= [+][-] DD**

This command allows the amplitude difference between TONE #1 and TONE #2 (of PULSE #1 and PULSE #2) to be programmed in the Selective Calling mode of operation. The total may range from -40 to +40 dB and can be specified with 1 dB resolution. The value of the difference specifies TONE #1 with respect to TONE #2.

COMMAND: SET SELECTIVE CALLING PULSE #1 CODE  
 FORMAT: **SCL 1 CODE= AA**

This command allows the PULSE #1 code to be programmed in the Selective Calling mode of operation. The code specifies the frequency of the two tones modulated in PULSE #1. The first ASCII character in the code specifies TONE #1 frequency and the second specifies TONE #2 frequency. The code may range from A to S for each tone.

COMMAND: SET SELECTIVE CALLING PULSE #2 CODE  
 FORMAT: **SCL 2 CODE= AA**

This command allows the PULSE #2 code to be programmed in the Selective Calling mode of operation. The code specifies the frequency of the two tones modulated in PULSE #2. The first ASCII character in the code specifies TONE #1 frequency and the second specifies TONE #2 frequency. The code may range from A to S for each tone.

COMMAND: SET PULSE #1 TONE #1 FREQUENCY  
 FORMAT: **SCL 1 TONE 1= DDDD[.D]**

This command allows changing the standard frequency (set with SCL 1 CODE command) for TONE #1 of PULSE #1 for the Selective Calling mode of operation. The frequency is specified in Hz using 0.1 Hz resolution and the range is from 100 to 9999.9 Hz.

COMMAND: SET PULSE #1 TONE #2 FREQUENCY  
 FORMAT: **SCL 1 TONE 2= DDDD[.D]**

This command allows changing the standard frequency (set with SCL 1 CODE command) for TONE #2 of PULSE #1 for the Selective Calling mode of operation. The frequency is specified in Hz using 0.1 Hz resolution and the range is from 100 to 9999.9 Hz.

COMMAND: SET PULSE #2 TONE #1 FREQUENCY  
 FORMAT: **SCL 2 TONE 1= DDDD[.D]**

This command allows changing the standard frequency (set with SCL 2 CODE command) for TONE #1 of PULSE #2 for the Selective Calling mode of operation. The frequency is specified in Hz using 0.1 Hz resolution and the range is from 100 to 9999.9 Hz.

COMMAND: SET PULSE #2 TONE #2 FREQUENCY  
 FORMAT: **SCL 2 TONE 2= DDDD[.D]**

This command allows changing the standard frequency (set with SCL 2 CODE command) for TONE #2 of PULSE #2 for the Selective Calling mode of operation. The frequency is specified in Hz using 0.1 Hz resolution and the range is from 100 to 9999.9 Hz.

COMMAND: SET SELECTIVE CALLING PULSE #1 TIME  
 FORMAT: **SCL 1 TIME= D.DDD**

This command programs the pulse width of PULSE #1 in the Selective Calling mode of operation. The range is from 0 to 2.000 S in .001 S steps.

COMMAND: SET SELECTIVE CALLING PULSE #2 TIME  
 FORMAT: **SCL 2 TIME= D.DDD**

This command programs the pulse width of PULSE #2 in the Selective Calling mode of operation. The range is from 0 to 2.000 S in .001 S steps.

COMMAND: SET SELECTIVE CALLING GAP TIME  
FORMAT: **SCL GAP TIME= DDD**

This command programs the period of time between PULSE #1 and PULSE #2 in the Selective Calling mode of operation. The range is from 0 to 999 ms in 1 ms steps.

COMMAND: SET SELECTIVE CALLING TEST FREQUENCY  
FORMAT: **SCL TEST FREQ= DDDDD.D**

This command programs the test frequency used in the Selective Calling mode of operation. This frequency is output as a test tone following the Selective Calling pulses. The range is from 10.0 to 18000.0 Hz in 0.1 Hz steps.

COMMAND: SET TEST TONE PERCENT OF MODULATION  
FORMAT: **SCL %MOD= DD[.DD]**

This command allows the percent of modulation to be programmed for the test tone in the Selective Calling mode of operation. The total may range from 0 to 99.00 % and can be specified with 0.01 % resolution.

### 3.7 USING THE EXTERNAL AUDIO INPUT

To operate the NAV 2000R in External Modulation Mode, the mode is first selected through the Utility menu. This is accomplished by pressing and holding any of the mode select keys for more than two seconds. Then, the EMM mode is selected by pressing number 2 from the numeric keypad. The external modulation is applied to the RF Modulator Module EXT MOD IN input which is accessible on the rear of the NAV 2000R.

The external audio input may be used in two ways. The audio applied may be summed with internally generated audio, or may be controlled separately within the EMM mode. External audio is AC coupled with a flat frequency response from 10 Hz through 22 kHz. The external audio input may be switched on or off during the five primary modes by means of the UTILITY MENU or automatically turned on, upon entering the EMM mode.

During the primary operational modes of the NAV 2000R, the external audio is equally summed with internally generated audio. With an input level of 1.00 volt peak, the total modulation depth is doubled. For example, if the total % mod is 40% in LOC mode and a 1.00 volt peak signal is applied to an enabled external mod audio input, the total modulation depth may be as high as 80%. Adjusting the input audio level from the 1.00 V peak level will change the ratio of the internal to external audio applied to the RF modulator.

In the EMM mode, all internal audio generation is switched off. The user may specify the modulation level produced from a fixed level external source. An audio level indicator tells the user when the proper level is applied. At this point, the depth of modulation produced matches the specified modulation %. The NAV 2000R is normally calibrated for an input audio level of 1.00 V peak.

### 3.8 USING AUDIO OUTPUT

The composite audio signal is accessible at the rear of the NAV 2000R. This signal is capable of driving a 600  $\Omega$  load and is calibrated to provide a fixed 2 V peak signal. Only during the audio control modes, VORa and LOCa, the output varies, from 0 to 1 V rms, according to the value set within the audio level field.



## **SECTION IV THEORY OF OPERATION**

### **4.1 GENERAL INFORMATION**

The NAV 2000R Theory of Operation is contained in this Section. The General Description section describes the function of the various parts of the hardware. The Functional Description discusses the output parameters of the NAV 2000R. The Software section covers the software with respect to how it affects the hardware.

### **4.2 UNIT DESCRIPTION**

The NAV 2000R has three major sections; the front panel, rear panel and chassis. The front panel includes the keypads, power switch and display and is used for local operation. The chassis section includes the housing, power supply, and line power connection. Within the housing is a card cage which contains the motherboard and slots for the system computer (CPU) board, DSP board, and AM Modulator Module. The synthesizer module is mounted next to the card cage.

#### **4.2.1 FRONT PANEL**

The front panel contains the flat panel electro-luminescent display, the ON/OFF power switch, the mode select keypad, the cursor control and select keypad, "hot" key keypad, and the numeric keypad. Each of the keypads are part of one keyboard. The display horizontal sync, vertical sync, clock, and display data are routed to the display through the keypad board.

The keypads are mapped into two banks. When a key is depressed (after debouncing), its row and column are latched on the keypad board. Additionally, the row and column is decoded to determine whether the depressed key is from the upper or lower bank. This bank decoding actually forms part of the address which the system processor uses to access the latches which indicate row and column.

The display is driven by the system computer board. The video dynamic RAM is written to the display on a refresh basis. To refresh the display, a DMA of the contents of the video RAM to a parallel to serial interface is done every horizontal sync period. The parallel to serial interface converts the dynamic video RAM contents to a two byte row and column address. Although the write to the interface is on one write cycle, the write to the display is actually on two write cycles; one for the row and one for the column. The data is then applied to a parallel to serial converter and, along with the generated clock and horizontal and vertical syncs, is routed through the keypad board to the display.

#### **4.2.2 REAR PANEL**

The rear panel provides access to the card cage modules, the power connector, fuse holder and the synthesizer module. The system computer board, DSP board, and AM module are removable from the rear panel. The system computer board provides an IEEE-488 interface connector. The external mod audio input, RF input, and RF output are provided as part of the AM modulator. An audio output is provided as part of the DSP board. Time base input and output are provided as part of the synthesizer module.

### **4.2.3 CHASSIS INTERIOR LAYOUT**

The chassis interior consists of the power supply, card cage, and interconnection wiring.

The power supply voltages are +5 V, -12 V, and +15 V.

The card cage is built around the motherboard which has filtering and voltage regulation. It provides +5 V digital and +5 V analog voltages and regulated -5 V digital and -5 V analog voltages. The system computer board, DSP board, and RF module plug into connectors located on the motherboard. The synthesizer module plugs into a ribbon cable and a RF cable coming from the motherboard

## **4.3 FUNCTIONAL DESCRIPTION**

The output parameters of the NAV 2000R are discussed in the following sections.

### **4.3.1 RF OUTPUT LEVEL**

The RF Output level control is provided by an automatic leveling loop and a programmable step attenuator. The programmable step attenuator and leveling loop provide 0.1 dB steps. These are controlled automatically by the system computer and drivers located on the audio board of the RF Modulator Module and found on the front panel of -50 models. The RF output is found on the edge of the RF Modulator Module accessible from the rear panel on -60 models. The output can be set from 0 dBm to -127 dBm. The leveling loop is temperature and frequency response compensated.

### **4.3.2 FREQUENCY**

The RF frequency coverage provided is .15 MHz to 450 MHz. This is generated within the synthesizer module. The output level of the synthesizer is maintained at -20dBm. A 10 MHz TCVCXO is used as the internal frequency standard. An external standard of 10 MHz may be applied at the TIMEBASE, 10 MHz INPUT. Sensing a signal applied at the 10 MHz INPUT, the synthesizer will automatically switch, phase locking the internal standard to the applied external standard.

### **4.3.3 VOR SIGNAL GENERATOR**

The VOR audio signal is generated by the DSP board and is used to amplitude modulate the RF input signal. The VOR signal is computed by the DSP and consists of a 9960 Hz tone, frequency modulated at 30 Hz, summed with a 30 Hz tone. The phase relationship between the 30 Hz FM of the 9960 Hz carrier tone and the 30 Hz tone represents bearing information. To this, the DSP may add an identification of either a 1020 Hz tone or 6 digit Morse code word at 1020 Hz. The composite audio signal is set for percent modulation by the audio board of the AM Modulator Module.

### **4.3.4 ILS SIGNAL GENERATOR**

The ILS signals consists of Localizer (LOC), Glide Slope (G/S), and Marker Beacon (MKR). The audio signals for each is generated by the DSP board and amplitude modulate the RF input signal. The conditions of the modulating audio composite signal is controlled by the system computer.

Both LOC and G/S consist of a 90 Hz tone and a 150 Hz tone at variable amplitudes depending upon the DDM (Difference in Depth of Modulation) setting. The DSP processor computes the composite modulating signal. First, it sets up the amplitude ratio needed to achieve the DDM setting based upon which beam is selected as a reference: LEFT or RIGHT for localizer, TOP or BOTTOM for G/S. For LOC only, an identification of either a 1020 Hz tone or a one to six letter Morse code word at 1020 Hz may be added to the 90 Hz and 150 Hz tones. The audio signal for both LOC and G/S is applied to the audio board attenuator where it is attenuated according to the current modulation percentage before amplitude modulating the RF carrier on the RF modulator board. For G/S, the sum of the 90 Hz and 150 Hz modulation percentages cannot exceed 99% and for LOC the sum of the 90 Hz, 150 Hz, and 1020 Hz modulation percentages cannot exceed 99%.

Marker Beacon (MKR) audio signals are generated by the DSP processor board and are a user specified tone. The MKR audio signal may be pulsed at a rate determined by the beacon selected: inner, middle, or outer. The percent modulation is achieved by the attenuator on the audio board before amplitude modulating the carrier on the RF Modulator Board. The marker beacon frequency may be programmed away from its normal setting, anywhere from 10 to 18,000.0 Hz with 0.1 Hz resolution.

#### **4.3.5 COM SIGNAL GENERATOR**

The COM (Communications) audio signals are generated by the DSP board. One or two tones of user specified frequency are generated by the DSP processor to test communications equipment. The percent modulation is set by the system controller processor using the attenuator on the audio board. The sum of the two tones is limited to 99%. Then, on the RF Modulator Board, the audio signal amplitude modulates the RF carrier.

#### **4.3.6 SYSTEM COMPUTER BOARD THEORY OF OPERATION**

The system computer board controls the operation of the NAV 2000R. It consists of a microprocessor, a boot ROM, four memories, a GPIB interface, a video generator, a keyboard interface, buss control circuitry, discrete hardware control, and a slave controller. A block diagram of the board (JPN 40-5742-00) is located in Section V of this manual.

The microprocessor starts by running EPROM boot code. This boot code, residing in EPROM, verifies the operating code residing within the EEPROM. With operating code verified, program execution jumps to the EEPROM.

The battery backed RAM contains system status flags, calibration information, global system parameters, and the operator setup memory. Each mode may store up to 49 setups in program memory. When saved, the complete system record is saved. Thus, when recalled, the system will return to that state. Memory 0 recalls the factory set defaults.

The MUART (Multi-function Universal Asynchronous Receiver & Transmitter) provides serial communication ability, discrete hardware control, additional timers, and a slave interrupt controller. The slave interrupt controller has as inputs the key pressed interrupt, and the buss grant error interrupt. These in turn are hardware interrupts to the processor.

The GPIB interface provides a GPIB talker/listener ability. Provision for a GPIB controller is also present but is not implemented.

The video generator decodes row and column data and transmits the data to the display. Also, the microprocessor generates the horizontal and vertical sync signals. A 16.384 MHz clock is provided to the display to clock in data.

The Bus Request / Bus Grant circuitry is used by the microprocessor to control the DSP board and RF Modulator Module busses. A Bus Request addresses a board or module. The board or module floats all necessary local buss control lines and returns a Bus Grant. Each Bus Grant is an open collector output simplifying their parallel connection.

The keyboard Bank Latch selects the bank of keyboard keys, upper or lower, which are read upon a key press interrupt service read.

### 4.3.7 DSP BOARD THEORY OF OPERATION

The digital signal processor board of the NAV 2000R is designed around Analog Device's digital signal processor, ADSP 2105. The board generates various fixed level complex waveforms. The digital signal processor uses a sine lookup table ROM to obtain values for sine and cosine functions (reference DSP Board Block diagram, JPN Drawing 40-5743-00, located in Section V of this manual). The DSP board generates simple tones, frequency modulated tones and a combination of these signals. Digital data from the DSP processor is sent to a 8 times oversampling digital filter whose output rate is 8 times higher than the input sample rate. The digital filter adds additional reconstruction points according to the algorithm and coefficients stored in the filter chip. The output of the digital filter is applied to a serial input 16 bit D/A converter. The output of the D/A converter is passed through a 3 pole lowpass Butterworth filter. The filtered output is available internally at the main connector. A buffered output is available through a BNC connector.

The output function of the DSP board is divided into two modes: 1) VOR mode, 2) Alternate mode. In the VOR mode, the output waveform is a combination of three tones with variable amplitude, with one of the tones being frequency modulated. In alternate mode, the output waveform is a combination of a maximum of three variable amplitude tones.

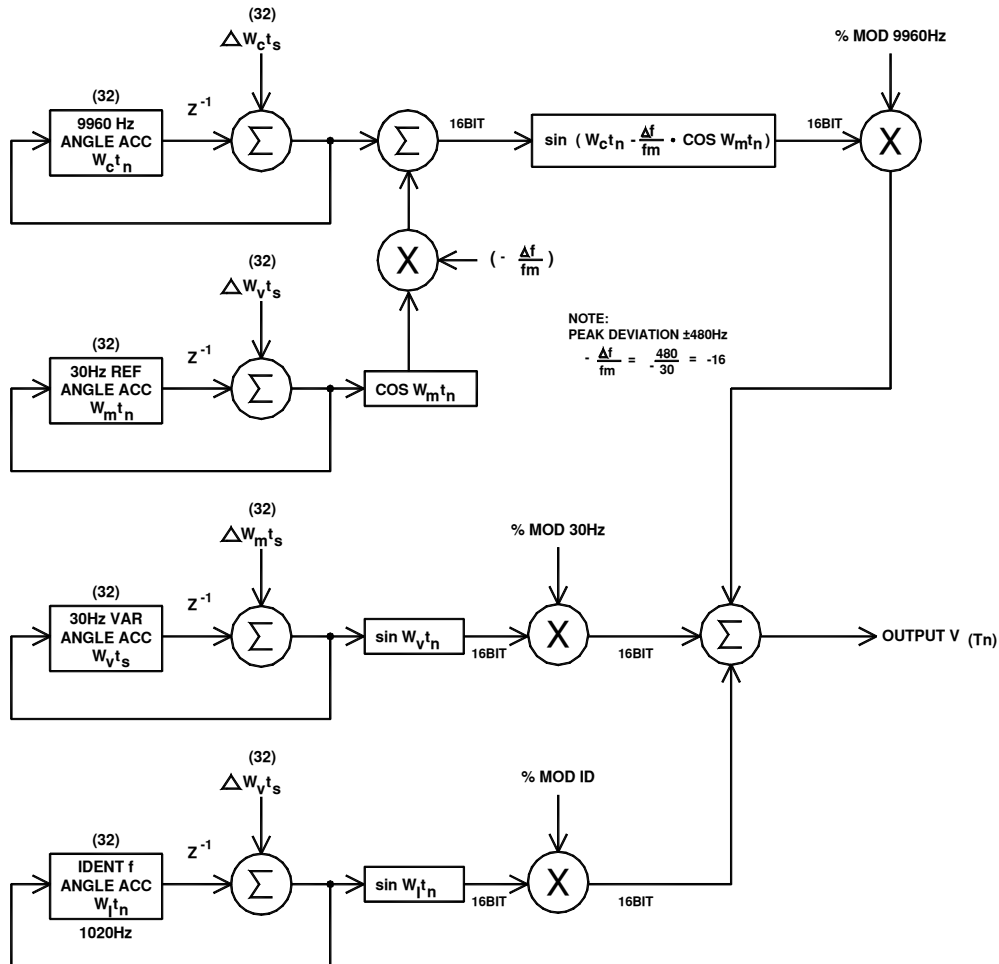

**FIGURE 4-1: VOR SIGNAL GENERATOR BLOCK DIAGRAM**

The following equation describes the VOR mode:

$$A_C \text{SIN}(w_C t_i - (df/f_m) \cdot \text{COS}(w_m t_i)) \\ + A_V \text{SIN}(w_V t_i) + A_I \text{SIN}(w_I t_i)$$

where,

$A_C$  = Amplitude of the carrier signal.

$A_V$  = Amplitude of the reference signal.

$A_I$  = Amplitude of the ident signal.

$w_C t_i$  = Instantaneous phase of the carrier.

$w_m t_i$  = Instantaneous phase of the modulation signal.

$w_V t_i$  = Instantaneous phase of the reference.

$w_I t_i$  = Instantaneous phase of the ident tone.

$df$  = Peak frequency deviation = +/- 480 Hz

$f_m$  = Frequency modulation = 30 Hz

The first term is a carrier signal with the frequency modulated reference. The second term is the variable signal and the third term is the identification (ident) signal. The VOR ident signal may be used to generate Morse code. VOR is a complex signal which combines a variable amplitude frequency modulated carrier and two variable amplitude tones.

The alternate mode sums three individual tones with variable amplitudes. The following equation describes the alternate mode:

$$A_1 \text{SIN}(w_1 t_i) + A_2 \text{SIN}(w_2 t_i) + A_3 \text{SIN}(w_3 t_i)$$

where

- $A_1$  = Amplitude of the tone 1 signal.
- $A_2$  = Amplitude of the tone 2 signal.
- $A_3$  = Amplitude of the tone 3 signal.
- $w_1 t_i$  = Instantaneous phase of tone 1.
- $w_2 t_i$  = Instantaneous phase of tone 2.
- $w_3 t_i$  = Instantaneous phase of tone 3.

The first term is the instantaneous amplitude of tone 1. The second and the third term are the instantaneous amplitude of tone 2 and tone 3.

#### 4.3.8 RF MODULATOR MODULE DESCRIPTION

The RF modulator module amplitude modulates (AM) a CW carrier input with an audio input signal and provides control over percent modulation and average power output.

The RF modulator module consists of an audio board, an RF modulator board, and a programmable step attenuator. The modulation of a CW carrier is achieved by applying the CW signal to the RF modulator board where it is modulated by signals appropriately conditioned for percent modulation by the audio board. The output power is leveled on the RF modulator board and the desired output power level is achieved by switching in sections of the programmable step attenuator, for each 1 dB step and by moving the reference voltage controlled by the leveled output power for each .1 dB step.

The boards are interfaced to the NAV 2000R system computer via the audio board which controls the RF board and step attenuator. An in depth treatment of the modulation process is provided in the following sections.

JPN Drawing 40-9520-51 (located in Section V of this manual) shows the Block diagram of the RF Modulator Module. An operational explanation of the process of modulation and a functional description of each of the module components follow.

#### 4.3.9 MODULATOR GENERAL OPERATIONAL DESCRIPTION

The general operation of the NAV 2000R RF modulator module is discussed in this Section. Also reference JPN Drawing 40-9520-51 (located in Section V of this manual).

The module consists of an audio board, an RF board, and a programmable attenuator. An RF carrier is applied to the RF input port via the mother board. This CW signal is generated within the synthesizer module.

The amplitude modulating audio signal is either generated internally by the NAV 2000R DSP board or provided externally from the external audio input. On the audio board, the modulating audio signal level is adjusted and monitored to generate the desired modulation percentage. Then, it is applied to a temperature compensating amplifier on the RF board. This signal is then applied as a gain controlling bias to a variable gain amplifier which acts as an RF modulator.

The modulated RF signal is amplified and the output is leveled by an automatic leveling control loop. An audio detector in the automatic leveling control loop circuitry also provides the detected audio output. After leveling, the modulated RF carrier is applied to a programmable step attenuator.

The programmable step attenuator circuit allows the output power to be programmed in 1.0 dB steps while the leveling loop adjusts output power in 0.1 dB steps. The external audio modulation input is provided on the rear panel. The modulator module also generates RF output high/low, audio input high/low, and detected audio high/low (at 50% modulation with a single tone) indications to the NAV 2000R system computer. The system computer monitors these indicators to provide some self testing during normal operation and during power on self test.

#### **4.3.10 AUDIO BOARD OPERATION**

The audio board accepts a fixed level audio signal. The level of this signal is adjusted and summed with a DC voltage level to produce a 1 + modulation signal achieving the desired modulation percentage. It also provides a bus interface for the RF modulator module to the NAV 2000R system computer. This enables the system computer to control and monitor the module.

The audio signal input to the audio board can either be generated by the NAV 2000R DSP board or applied via an external input. The external input may be switched on or off. It is AC coupled into the modulator audio circuitry.

The RF Modulator Module Bus Interface circuitry provides the bus interface to the NAV 2000R system computer. It consists of bus request/bus grant bus timing circuitry, RF modulator command decoding, and RF module control signals.

The Modulation Centering & Calibration circuitry, Audio High/Low Indication circuitry, and % Modulation Level Set Attenuator circuitry are used along with the Voltage Reference to provide a precisely calibrated audio modulating signal to the RF Board.

The Audio High/Low Indication circuitry indicates whether or not the audio input amplitude has been properly set. A single tone modulating signal is applied and if its peak falls one half percent above or below the required peak amplitude, an indication is provided. The status of these high/low bits are read by the NAV 2000R system computer.

The Percent Modulation Level Set Attenuator attenuates the audio input signal by an amount which corresponds to a desired percent modulation. Subsequently, the audio input signal is added to a DC level in the % Modulation Centering & Calibration circuit. Assume that the DC level is normalized to 1. Then, after adding the audio input with no attenuation the resultant signal should give 100% modulation. For 100% modulation, the largest peak reaches the normalized value of 2 and deepest null swings to zero. The required attenuation values used to achieve from 0% to 100% modulation are stored in the NAV 2000R system computer. Therefore, to achieve 50% modulation, the modulating signal applied to the audio board will have its amplitude reduced by a factor of one half. Note that percent modulation is given by

$$\% \text{ mod} = [(1+m)A - (1-m)A] / [(1+m)A + (1-m)A] * 100 = m * 100\%,$$

where m is the modulation index and A is the carrier amplitude. The modulation index parameter controls the relative proportions of sideband to carrier levels. The factor m is also the factor by which the input signal should be attenuated to achieve a desired percent modulation, i.e. for 50%, m=.5 and for 25%, m=.25, etc.

The % Modulation Centering & Calibration circuitry adjusts the DC level of the composite modulating signal and calibrates the audio modulating signal. Before being applied to the RF modulator, the audio signal must have the proper AC and DC levels. The DC level determines the range of RF levels which the Voltage Gain Amplifier of the RF modulator board will produce. This DC level is set so that the variable gain input to the VGA provides the optimum dynamic range. Due to the wide linear dynamic range of the gain control input, the DC component of the audio signal is not highly critical. However, the AC component of the audio signal applied to the VGA must be calibrated very accurately, as it determines the % modulation. Calibration of the AC component is achieved by setting the % modulation attenuator to provide 50% modulation modulating signal. Then, the centering and calibration circuitry with the voltage reference adjusts the resultant modulated RF output to be 50.0% (measured using a modulation meter).

The Programmable Step Attenuator Control circuits provide control signals which set the attenuation of the Programmable Step Attenuator, respectively. The Programmable Step Attenuator has eight control lines which provide values of attenuation in one dB steps. The step attenuator program word is not sequential. Each control line activates either a one, two, four, eight, sixteen, thirty two, or sixty four dB attenuator. Thus, to obtain a given value of attenuation the proper values of attenuation must be selected so that the sum total of the attenuation is that which is desired. As a result, the control word, which controls the value of attenuation, being non-sequential, is stored in NAV 2000R system computer memory.

To achieve 1/10th dBm steps, a circuit is added to allow the step attenuator setting to be varied. This circuit uses a DAC circuit to vary a reference signal to the leveling loop.

The detected Audio Hi/Lo Indication circuitry indicates whether or not the RF detector is working properly. It is set up to measure the peak of a single tone modulating signal at 50% modulation. If the peak is greater than the acceptable high level or less than the acceptable low level then an appropriate indication is made. A high or low indication could mean that the detector or leveling loop are functioning improperly or that the RF calibration level has become uncalibrated.



### 4.3.11 RF MODULATOR BOARD OPERATION

The RF Modulator Board circuitry provides two basic functions: AM modulation and automatic RF leveling. Both functions are achieved using variable gain amplifiers (VGA's). Temperature compensation is also provided to correct for gain variations of RF amplifiers with temperature.

The audio signal, conditioned to achieve a desired percent modulation by the audio board, is applied to the Modulating Signal Temperature Compensation circuitry. The modulating signal is then applied to the first VGA's gain control input to amplitude modulate the CW RF signal applied to the RF input of the RF modulator. The Modulating Signal Temperature Compensation network removes the gain temperature dependence of the first VGA stage.

The second VGA amplifier is part of the automatic leveling loop. It is followed by three stages of amplification, which boost the signal to the desired level. At the output of the final fixed gain amplifier, a portion of the signal is detected by a temperature stable detector.

The Temperature stable Detector circuitry detects the modulation of the RF carrier and corrects for the temperature dependence of the detector diode. The detected modulating signal is then applied to the Detected Audio Hi/Lo Indication circuitry and to the Low Pass Filter & Integrator circuitry. The Detected Audio Hi/Lo Indication circuitry is on the audio board and is discussed above. The LPF & Integrator circuitry filters and integrates the detector output to determine its average DC level. This signal is an input to the RF leveling output leveling loop.

In the Scaling & RF Level Set circuitry, the DC signal from the LPF & Integrator circuitry is used in conjunction with the voltage reference provided on the audio board to generate the gain control voltage for the second VGA. This closes the RF leveling loop. If the detected RF output level is too high, the gain control voltage on the second VGA is reduced; if too low it is increased.

The RF High/Low Indication circuitry indicates the ability of the second VGA to level the RF output power. If the output level falls to a low level which is very small due, for example, to an amplifier malfunction, the gain control voltage would go to its maximum value in attempting to restore the RF output level. Similarly, if for some reason the detected RF output level was exceedingly high, the VGA control voltage would drop in attempting to lower the RF level. In either case, the indication circuitry would set bits indicating the leveling loop is out of its control limits.

#### **NOTE:**

The RF level high/low indication bits do not mean that the RF output power is within a certain window of its desired level. They simply indicate proper operation of the leveling loop in leveling RF output level.

### 4.3.12 PROGRAMMABLE STEP ATTENUATOR CIRCUIT

The programmable step attenuator provides control over the output power level. It provides the ability to have outputs from 0 dBm to -127 dBm in 1/10th dB steps. The drivers for each of the step attenuators, along with the 1/10th dBm control circuit, are found on the audio board.

### 4.3.13 SYNTHESIZER

The synthesizer module consists of the REFERENCE/CONTROL board, the RF/OUTPUT board, the MAIN VCO board, and the 400 MHz VCO board. A block diagram of the module (JPN 40-9520-52) is located in Section V of this manual.

Referring to this block diagram, frequency generation begins with the 10 MHz Temperature Compensated Voltage Controlled crystal Oscillator. The output of this frequency standard is buffered and sent throughout the REF/CONTROL board, and to the RF/OUTPUT board as the reference for the 400 MHz phase lock loop. Within the REF/CONTROL board, this 10 MHz is transformer coupled to the TIME BASE, 10 MHz OUTPUT jack, buffered and sent to a 10 MHz phase detector, buffered and sent to the microprocessor and Direct Digital Frequency Synthesizer circuitry, and buffered and sent to the mixer circuit.

The 10 MHz sent to the reference phase detector, allows an external 10 MHz reference to be used as the frequency standard. A signal sensed at the 10 MHz INPUT causes the output of the Low Passed filtered phase detector to be applied to the voltage control of the TCVCXO, thereby phase locking the internal standard (TCVCXO) to the externally applied reference signal.

The 10 MHz is used by the microprocessor and direct digital frequency synthesizer as basic operating clocks. The microprocessor interfaces with the NAV 2000R system buss and generates the control signals required to program and monitor frequency generation. The Direct Digital Frequency Synthesizer clocks into the Digital to Analog Converter values at a 10 MHz rate that produces a sine wave of 700 kHz plus or minus 1.2 kHz with millihertz of resolution.

The output of the DAC is passed through a 1 MHz low pass filter and then to a mixer. Here it is mixed with the 10 MHz to produce 10.7 MHz plus or minus 1.2 kHz. The filtered output of the mixer is passed to the RF/OUTPUT board where it is used as the reference for the MAIN phase lock loop.

The RF/OUTPUT board consists of a MAIN phase lock loop, RF divide by two and divide by four circuits, harmonic suppression filter networks, 400 MHz phase lock loop, low band mixer, and an output leveling circuit.

The Main phase lock loop uses a PLL IC which incorporates reference dividers, a dual modules prescaler, divide by A and N counters, and a digital phase detector. The 10.7 MHz reference from the REF/CONTROL board, is divided by 214 to produce an internal 50 kHz reference for the phase detector. The Main VCO output is divided by, the divide by 64/65 prescaler, and the A and N counters. This produces a total divide ratio of from 4500 to 9125, thus the VCO frequency produced will vary from 225 MHz to 456.25 MHz. The 50 kHz phase detector reference allows the PLL to be programmed in 50 kHz steps. To produce the smaller 10 Hz steps, the 10.7 MHz is skewed up or down. As described previously, this is done by the Direct Digital Frequency Synthesizer on the REF/CONTROL board.

The Main Loop is only required to produce a frequency range of 225 MHz to 456.25 MHz for the NAV 2000R synthesizer to generate output frequencies of 150 kHz to 450 MHz. For output frequencies of 225 MHz to 450 MHz, the Main Loop output is used directly. For output frequencies from 112.5 MHz to 225 MHz, the Main Loop output is divided by two. For output frequencies of 56.25 MHz to 112.5 MHz, the Main Loop output is divided by four. To produce the Low Band range of 150 kHz to 56.25 MHz the Main Loop output is mixed with a fixed 400 MHz.

The selected output, direct, divided by two, or divided by four, is passed through an appropriate low pass filter to reduce harmonics. There are two filters per octave. The approximate corner frequencies of each filter and the output frequency range passed by each is listed below. For output frequencies of 56.25 to 75.5 MHz a 90 MHz LP is selected. For output frequencies of 75.5 to 112.5 MHz, a 130 MHz LP is selected. For output frequencies of 112.5 to 155 MHz, a 180 MHz LP is selected. For output frequencies of 155 to 225 MHz, a 260 MHz LP is selected. For output frequencies of 225 to 310 MHz, a 375 MHz LP is selected. For output frequencies of 310 to 450 MHz, a through path is selected.

The 400 MHz Loop is used to generate a 400 MHz LO signal for the Low Band Mixer. Applied to this loop phase detector, are the 10 MHz reference from the REF/CONTROL board and the output of a divide by 40 RF prescaler. The output of the phase detector is low pass filtered and applied to the tuning line of the 400 MHz VCO.

The output of the 400 MHz VCO is buffered and applied as the LO of the balanced Low Band Mixer at a level of 7 dBm. The Main VCO output is padded down and applied to the Mixer RF input. The IF output of the Mixer is filtered by a 68 MHz low pass filter and amplified. The resulting output is the Low Band frequency of between 150 kHz and 56.25 MHz.

The 400 MHz VCO may be switched on or off. This VCO operates only during Low Band frequency generation.

The Main VCO is actually four VCO's, each covering only a part of the Main VCO frequency range. The output of each VCO is combined, buffered, and split. Only one of the four VCOs operate at one time. The outputs are split three ways; to the PLL buffer and two, to an output buffer.

All of the possible outputs are combined and then passed through a 500 MHz LP filter. Following this filter is the leveling loop. The leveling loop is composed of a voltage controlled attenuator, an Amplifier, and a diode detector and error amp. This loop maintains the output level of the synthesizer at -20 dBm.

#### **4.3.14 REVERSE POWER PROTECTION MODULE (-50 units with Mod Status 7 only)**

The Reverse Power Protection (RPP) module provides a mean for interruption of the RF path between the unit under test (UTT) and NAV 2000R output. Should a high RF signal be fed to the NAV 2000R output connector, while testing a transceiver for instance, an internal switch in series with the RF output will open. In addition to RF protection, the RPP module also contains a DC block, which will prevent damage to the output stage if connected to a circuit operating at a DC potential.

#### **4.4 NAV 2000R SOFTWARE**

Following is a short description of the NAV 2000R basic operating software. The software versions are displayed upon power up.

The operation software of the NAV 2000R resides on the system computer board. This software controls all other boards and modules within the NAV 2000R. The display characters and fields are defined by the software, which writes the display information into Video Ram. Hardware, under software control within the system computer board, outputs the contents of Video Ram to the display. The keyboard interrupts the main program. Interrupt handling routines receive and pass the key value to the main program. The main program processes the new information. Interrupts from the GPIB bus are handled similarly.

The software on the system computer board passes control words to and reads status from, the DSP board and the Modulator assembly.

The information passed to the Modulator tells the modulator the % MOD to output, and the audio source and conditioning to be used. The status passed back from the modulator allows the system software to monitor the modulator operation.

The information passed to the DSP board tells the DSP board the operational mode, the audio frequencies to be generated, the phase relationship of these signals, the amplitude relationship of these signals, and Morse code characters and timing to be used. The status passed back from the DSP allows synchronization of variables passed and allows the system software to monitor the DSP operation.

The DSP software is downloaded from the system computer on power up. The DSP runs this software to actually generate the audio signals.

#### **4.4.1 SELF TEST**

The NAV 2000R performs a self test during power up. This self test includes the following checks and measurements.

The CPU board reads, calculates, and compares the calculated checksum with the stored checksum within EPROM, EEPROM (UV BOOT and DYNAMIC ROM), and Battery RAM. It also writes and reads patterns to the operational RAM (STATIC) to verify its functionality. The CPU then writes and reads the DSP board RAM (PROGRAM BOOT ram) to verify it. The DSP program is then transferred to the DSP RAM. Upon the CPU releasing the DSP reset, the DSP processor reads, calculates and compares a stored checksum with the calculated checksum of the SINE look up ROMs residing on the DSP board. The DSP processor writes these test results into a status register. The CPU board displays the results of the ROM and RAM tests on the SYSTEM DIAGNOSTICS NAV 2000R display.

The MODULATOR is checked next. To do this the CPU board tells the DSP board to generate a single 1000 Hz tone, and tells the modulator to produce a depth of modulation of 50.0 %.

The CPU board then reads the status bits of the modulator to verify the following: 1) Audio level outputted by the DSP and received by the modulator is the proper level. 2) Recovered audio out of the Modulator diode detector is proper for 50.0 % AM modulation. 3) The AGC control voltage of the RF OUTPUT leveling circuit is within its normal range. The CPU then displays these results on the SYSTEM DIAGNOSTICS display.

For all Modulator tests to pass, the modulator must have the RF IN signal applied at approximately the proper level and within the NAV 2000R frequency band. With no RF applied the RF level and detected Audio test will fail indicating outputs too low.

#### **NOTE:**

The self test discussed above is fully performed during normal operation. But if the FORCE BYPASS ON POWER UP configuration is selected, a shortened self test is performed. The last two steps of the MODULATOR tests; DETECTED AUDIO and RF LEVEL, are not performed. With RF switched off from the modulating circuitry these tests will always fail.

## 4.4.2 CALIBRATION

When the calibration procedure is entered, the system computer is directed to setup the DSP board and Modulator for each step of the procedure as it is displayed and followed.

For the first steps of internal audio, and Modulation alignment, the system computer tells the DSP board to generate a 1000 Hz sine wave, and tells the Modulator to set % MOD to 50.0% and RF level to -10 dBm. During the RF level alignment, the system computer turns off audio from the DSP board. During the External Modulation alignment, the DSP is told to turn off all internal audio, and the modulator is told to turn the external MOD AUDIO INPUT on.

During VOR Bearing calibration, external MOD audio input is switched off, and the DSP board is told to generate a VOR composite audio with a bearing of zero degrees. Modulation is set to the nominal VOR levels. The error value loaded by the user is used to calculate a calibration factor which is stored within the system computer and passed to the DSP board. The DSP shifts the phase of the VOR signal by this calibration factor. This factor will be used during all VOR generation until it is changed by the NAV 2000R user within the CAL procedure.

Finally, upon going to the next and last calibration step, the DSP board is told to generate a 1000 Hz tone.

Upon completing CAL, the NAV 2000R will return to the Utility Menu.

## 4.4.3 MEMORY USAGE AND INITIALIZATION

The NAV 2000R internally contains non-volatile memory to maintain it's setup after it is powered off. System configuration, current and registered parametric settings, and calibration data constants are some of the items stored within the battery backed RAM. The non-volatile memory module, U14, is an integrated battery backed-up static RAM module. If, for whatever reason, the battery RAM module is replaced, the part must be re-initialized.

To initialize the part the user must: 1) Re-initialize the 49 registers to update the data integrity of each. 2) Re-initialize the unit "on-time" clock and number of times unit has powered up counter. 3) Re-configure the NAV 2000R to the user's preference. 4) Re-calibrate the unit to insure good calibration constants.

### NOTE:

Dependent upon the BATRAM's initial data settings, the NAV 2000R may power up with a blank screen and a "\*\*\* BOOT ROM \*\*\*" annunciation toward the bottom portion of the display. If this occurs, press the 120 degree bearing "hot key" to force the unit to complete the power up, which will cause the JcAIR logo to be displayed and the unit power-up self test to execute, before proceeding.

1) Re-initialize the registers to update data integrity:

In the event the battery RAM is replaced with a new part, the power up self test of the NAV 2000R will fail the CPU RAM register memory test. This tells the user that one of the set-up registers contains bad data. To re-initialize the registers, one could save the current paged parametric data to each of the available locations by using the STO key (store) function for each of the available locations. This would re-write every register insuring good data for each. However; there is another way to clear the registers from within the Utility Menu. Push and hold one of the mode switches to request the unit to list the utility menu options. Option 7, SET ALL REGISTERS TO DEFAULT, will automatically clear all registers to factory default settings in one step. After pressing option 7, the system will require you to verify the clearing procedure by pressing the CLR (clear) key.

2) Re-initialize the unit on-time and power on counter:

From within the Utility Menu option 5 selection, DISPLAY SYSTEM STATUS, the amount of time and number of times the unit is powered on is displayed. With a new battery RAM module, these values need re-initialization. This is accomplished by pressing, and holding down the 120 degree bearing "hot key" for approximately two seconds.

3) Re-configure the NAV 2000R to the user's preference:

The user can now set the NAV 2000R to their desired configuration. This could be to set the GPIB address, and External Modulation settings.

4) Re-calibrate the unit to insure good calibration constants:

Since the unit's calibration constants are contained within the battery RAM module, the unit must be re-calibrated to insure the unit is producing the desired signals.

## 4.5 DETAILED CIRCUIT DESCRIPTIONS

The following sections cover provide detailed circuit descriptions and reference the schematics of Section V.

### 4.5.1 MOTHER BOARD CIRCUIT DESCRIPTION

The mother board, located at the front of the card cage assembly, contains printed circuits that connect the plug in assemblies; the CPU board, the DSP board, the Modulator module, and two optional cards. All signals going between these assemblies, and to and from the front panel keyboard, are routed through the mother board.

Power supply voltages are connected to the mother board at terminal block TB1. These voltages are +15Vdc, +5.2Vdc, and -12Vdc. The 5.2Vdc voltage at TB1 -2 and -3 is split between two filters formed by inductors L1 and L2 and capacitors C1, C2, C3, C4, and C5. These filter networks help isolate a +5v digital power bus from a +5V analog power bus. The -12Vdc voltage at TB1-1 is routed to the Modulator assembly mating connector J105, to Expansion connector J106, and to two voltage regulators U1, and U2. Regulator U1 drops the -12volts to produce the -5 volt power bus. Regulator U2 drops the - 12 volts to produce the -5 volt digital power bus.

### 4.5.2 SYSTEM COMPUTER (CPU) BOARD CIRCUIT DESCRIPTION

The System Computer Board is centered around the versatile 80C188 microprocessor and controls the operation of the NAV 2000R. Reference JPN Drawing 02-5742-00 located in Section V of this manual. The following sections discuss the System Processor Circuits.

The processor, U1, controls the keyboard, display, DSP processor board, RF Modulator Module, and GPIB communications, and system timing. The processor uses memory mapping to address various hardware devices. A feature of the system computer board is its use of battery backed RAM and EEROM (Electrically Erasable Read Only Memory). The battery backed RAM enables NAV 2000R to remember its last state through power ON/OFF cycles and provides a simple to use storage area for calibration constants and instrument test set-ups.

All board timing is derived from the processor clock. Crystal Y1, and capacitors C1 and C2 set the clock frequency to 16.384 MHz. Inverter U9 buffers the processor oscillator to drive all Mother board circuits requiring a clock.

The CPU board interfaces with the keyboard by means of seven lines. These consist of six key value lines KD0-5 and a key is pressed indicator KEYIN. KD0-4 lines are latched within the keyboard assembly while KD5 representing a bank select is latched on the CPU board by U38, clocked by KEYIN. KEYIN is applied to U28. U28 will generate a interrupt request to processor U1 whenever KEYIN goes high. The interrupted processor then reads the key value through tri-state buffer U39. KEYIN inverted by U16 is also applied to U28. A low at pin 34 of U28 starts a timer within U28. If a key is held for longer then the programmed times additional interrupts will occur.

Processor U1 determines and drives the NAV 2000R display. Timers within U1 generate the horizontal sync and vertical sync for the display. The values and fields displayed are generated by software within the processor and written to video rams U33 and U34. Interface to the processor bus is accomplished by ICs U30, U31, and U32. The video rams are dynamic, and need RAS and CAS timing for data writes and reads. Programmable logic IC U30 generates this timing. Quad 2 to 1 decoders U31 and U32 converts the 16 bit processor address into the two 8 bit row and column address. The video ram has two ports, the one discussed above and serial ports. Programmable logic within U35 generates the video ram output timing. Demultiplexer U36 converts the 8 serial ports of the two video rams into a single serial video data output. Hex D flip/flop U37 synchronizes the Video data, vertical and horizontal syncs to the display clock.

Information is passed between the CPU board and other circuitry by means of a parallel bi-directional bus. This bus consists of eight data lines which are multiplexed with the eight lower address lines, five additional address lines, address latch enable, a direction line, read and write, four request lines, and a bus granted line. The CPU board controls all bus transactions. When the CPU board needs to send or receive a byte of information to or from one of the other cards, it pulls the bus request line going to the card of interest low. IC U7 selects one of the four cards based on processor's (U1) address lines A13 and A14. The card addressed replies by pulling BUS GRANTED low. BUS GRANTED is common to all cards. This wired OR pull down is pulled to +5 v only through pull up resistor R9 on the CPU card. Once a bus request is asserted, processor U1's bus cycle will not complete until either BUS GRANTED is returned or a time out circuit on the CPU board expires. As can be seen on the CPU board schematic, inverted BUS GRANTED is ORed with monostable multivibrator (U15) output and applied to the ready pin of processor U1. Monostable multivibrator (U15) is retriggerable. A delay in the return of BUS GRANTED extends the read or write signals allowing the board addressed to set its own bus speed. The timeout furnished by monostable multivibrator (U15) is nominally 5 microseconds. Therefore, a wide range of board interfaces may be handled. Tri-state buffers U20 and U21 outputs are turned on only during bus requests isolating the processor bus from the external bus except during external bus transactions. Bi-directional bus transceiver U19 is similarly controlled, with the external bus isolated except during external bus operation.

### **4.5.3 DSP BOARD CIRCUIT DESCRIPTION**

The DSP board consists of a digital signal processor (U1), a digital filter (U7), a D/A converter (U15), a lowpass filter (1/2 U17), a buffer amplifier (1/4 U17), and interface logic (U8, U9, U10) to talk to the CPU board through connector J1 (see Aeroflex schematic 02-5743-10 for DSP board circuit diagram).

The DSP processor runs at 10.199 MHz. This is obtained by dividing the clock of the digital filter U7 by 2. The DSP generates a 2.5 MHz serial clock (SCLK1) for the bit clock input (BCI) of the digital filter. The DSP also outputs a 79.68 KHz transmit/receive frame sync pulse. This is divided by U5 to obtain 39.84 KHz. This is applied to the SDSY input of the filter which controls the serial data word rate.

A crystal between XI input and XO output of the digital filter and a capacitor from XO to ground produces the digital filter's 20.398 MHz clock frequency. This frequency is divided and used to clock the DSP processor. The bit clock input (BCI) is 2.5 MHz, which is 64 times the sampling frequency of 39.84 KHz. The 8 times oversampling filter causes the image frequency to occur between  $8F_s \pm F_s/2$ , where  $F_s$  is the sampling frequency. The image frequency occurs between 300 KHz and 340 KHz due to the oversampling frequency of 320 KHz. A 3 pole analog filter is used following the D/A converter, to remove unwanted signal outside the desired band of 0 to 18 KHz. Without a digital filter, the image frequency would occur between  $F_s \pm F_s/2$ , which are between 20 KHz and 60 KHz. This would require a higher order lowpass filter with a steep roll off between 18 KHz and 20 KHz.

The Bit Clock Output (BCO) of the digital filter is applied to the Clock Input (CLK) of D/A converter U15. The Word Clock Output (WCO) of the filter is connected to the latch enable (LE) pin of the D/A. The Left Channel Data output (DLO) is applied to the serial data input of the D/A converter.

The output of the D/A converter passes through a RC filter consisting of R5 and C1. Following this is a two pole low pass filter consisting of two sections of a quad operational amplifier, U17. The filtered output is available for use by the audio board at pin 14 of connector J1. A buffer, consisting of a section of U17 and associated discrete components, provides the output at the BNC connector J5. The amplitude of this output is adjustable by the potentiometer R9.

The DSP processor uses two 8 bit ROMS, U11 and U12 to read the 16 bit sine lookup table. U13 is an 8-bit RAM used as a boot ROM on power up and data memory RAM after booting is completed. The 14 bit DSP address bus is buffered by U9 and U10 and sent to connector J1 to be shared by the CPU board. The middle 8 bits of the DSP data bus is buffered by U8 and connected to J1 to allow CPU board access to the data bus. The CPU board's multiplexed address and data busses are connected to both U8 and U9. The bus request input (BR) and the bus grant output (BG) of the DSP processor are ORed, inverted and applied to the J input of U6. The Q output of U6 is in sync with the DSP clock. This is applied to the base of Q1. The R-C combination of R4 and C68 speeds up the switching time of Q1. The output at the collector of Q1 is used by the CPU board as a bus grant signal.

#### **4.5.4 RF MODULATOR MODULE CIRCUIT DESCRIPTION**

This section contains an operational description of the RF Modulator Module Circuitry. The Audio Board, RF Modulator Board and Variable Attenuator are each covered separately.

#### **4.5.5 RF MODULATOR MODULE BLOCK DIAGRAM**

JPN Drawing 40-9520-51, located in Section V, shows a block diagram of the RF Modulator Module. The current discussion on the operation of the Audio Board covers the Audio Board features shown on the block diagram. Also refer to the Audio Board schematic JPN Drawing 02-5761-20.

#### **4.5.6 RF MODULATOR MODULE BUS INTERFACE CIRCUITRY (AUDIO BD-A1)**

The RF Modulator Module interfaces to the NAV 2000R via system bus connector, J1. RN1 and RN2 provide pull ups to the system data bus, address bus, and control lines. The bus request is the system bus request 1. The features of the module can be addressed using system bus address lines A8 through A11. MOD AUDIO 1 is an internal audio input, which is supplied from the system DSP Board. U1 is a bus transceiver, which controls the direction of the data on the bus and also provides bus driving capabilities. U3 is a 3 to 8 line decoder, which selects the RF Modulator Module component to be accessed. A description of the functions addressed using the decoder is listed below as well as bus request / bus grant circuitry.



ADDRESS 0: A read of address 0 of U3 (output Y0) reads in the status word of the RF Modulator Module. High bits in this status word indicate error conditions as described in the Table below.

Data Bit	Description
0	Internal or External Modulating Audio too high
1	Internal or External Modulating Audio too low
2	RF output level unlevelled and too high
3	RF output level unlevelled and too low
4	Peak of detected audio for 50% modulation of a single tone too high
5	Peak of detected audio for 50% modulation of a single tone too low
6	N/A
7	N/A

A write to address 0 of U3 writes the MSB byte of the word, which sets the attenuation of variable attenuator (U7), which controls percent modulation. A write to address 1 of U3 writes the LSB byte of the percent modulation word to the percent modulation variable attenuator.

ADDRESS 2 & 3: Writes to addresses 2 and 3 of U3 write the MSB and LSB of the RF Fine tune level attenuator (U8), respectively. Use of this feature is reserved for future releases.

ADDRESS 4: Latches the byte that controls the programmable step attenuator into the attenuator driver U10.

ADDRESS 5: Latches a byte that controls the DISCRETE features of the module U11. Setting bit 0 of U11 high will enable external modulation to be AC coupled, and when cleared low, DC coupling. Setting bit 1 of U11 high enables external modulation and turns it off if cleared low. Setting bit 6 of U11 selects LOW BAND operation of the leveling loop.

To transfer data to and from the RF modulator module, the bus request line is held low. The bus grant line returns an active low bus grant signal after a short time indicating that the module is ready for reads or writes to its valid addresses. The bus grant is open collector as it is for all modules in the NAV 2000R. CR9 enables the acceptance and release times to have two different time constants. C46 allows high speed edges to bypass R4.

#### 4.5.7 EXTERNAL AUDIO CONTROL

External modulation can be turned ON or OFF. The External Modulation jack, J3, is normally calibrated for a signal with AC component of 1V peak. DC coupling is not used within the NAV 2000R.

Since external and internal modulation are summed, an external signal may be added to the internally generated modulating signals. However, the circuitry which indicates modulating level high/low will only indicate that their sum is high or low. During the External Modulation Mode, EMM, all internal audio is turned off. Adjusting an external modulating signals until the modulating high/low indicators show that the modulating signal is of an acceptable level will cause the output to match the selected modulation level.

#### 4.5.8 INTERNAL & EXTERNAL MODULATION SUMMING

During the five primary MODES which are selectable by means of the five MODE buttons, internal and external audio can be summed. The internal and external modulating signals are summed in one of the op amps of U12. The output of the summing amplifier, U12 pin 7, is the input to the Audio High/Low Indication circuit and the % modulation Level Set Attenuator. However, as previously mentioned, the modulating high/indication circuitry will only indicate whether or not the peak of the modulating signal is within a small percentage of a calibrated level, which is the level at which internal audio is maintained. Therefore, a summed internal plus external signal is not monitored by this circuitry.

#### 4.5.9 AUDIO HIGH/LOW INDICATION

The Audio High/Low Indication circuitry is on JPN Drawing 02-9520-00. This window level comparator monitors the positive peak level of the sum of the external and internal modulating signals to insure they are within acceptable limits. There are three possible states of the comparator:

- [1] Inadequate audio level - U14 pin 12 (Q bar) will be high; pin 13 will be low,
- [2] Acceptable audio level - U14 pins 12 & 13 are both low, and
- [3] Excessive audio level. U14 pin 13 will be high, pin 12 will be low.

If the positive peaks of the modulating signal do not exceed the bias on U13 pin 7, pin 1 will remain high and fail to trigger U14 pin 9. Therefore, U14 pin 12 (Q bar) will remain high, indicating a low modulating audio level.

If the positive peaks are high enough to produce pulses at U13 pin 1 but not so high as to exceed the DC bias at U13 pin 5 (a higher level than pin 7), pin 1 will generate triggers to U14 pin 9 and U14 pin 12 will go low. U14 pin 13 will remain low. With both U14 pins 12 and 13 low, an acceptable modulating signal level is indicated.

If the positive peaks of the modulating signal exceed the DC bias on U13 pin 5, pin 2 will generate trigger pulses at U14 pin 1, causing pin 13 to go high. This indicates a high modulating audio level. At the same time, of course, triggers from U13 pin 1 will cause U14 pin 12 to be at a low state.

The RC time constants in both sections of retriggerable one-shot U14 are sufficiently long that the outputs will remain triggered at the lowest anticipated modulating frequency, if signal levels at the inputs to voltage comparator U13 exceed bias levels for any fraction of the positive-going modulating waveform.

#### 4.5.10 % MODULATION LEVEL SET ATTENUATOR

This system attenuates the audio level from the summing amplifier to achieve the desired modulation percentage. It is comprised of digital-to-analog converter (DAC) U7, parts of gates U5 and U6, and part of op amp U9.

When address decoder U3 generates outputs on its 0 or 1 output lines, bus data forms the MSB or LSB input, respectively, to multiplying DAC U7. Audio from the summing amplifier is applied to the Vref input of U7.

Attenuation data written to U7 causes attenuation to be applied to the modulating audio signal. For example, when the bus data written to U7 causes an attenuation factor of .50 to be applied to the modulating audio, the resulting percent modulation will be 50%. For 99% modulation data is written to the attenuator to provide a 0.99 attenuation factor to the audio modulating signal. In this way, modulation percentage may be controlled to the nearest percent by the bus data. There is a direct relation between the data written to the attenuator and the resultant attenuation. The system computer stores the data to be written to the DAC to achieve the various attenuation's which produce the various % modulations.

The DAC audio output is buffered by part of op amp U9 and applied to the percent modulation centering and calibration circuit.

#### **4.5.11 % MODULATION CENTERING & CALIBRATION**

The % Modulation Centering & Calibration circuitry adds the appropriate DC offset level to the audio modulating signal and enables calibration. The DC level from the voltage divider of R41, R42, and R43 is added to the audio modulation signal. The voltage divider is sourced by the stable +5.0 Volt voltage reference, U15. By adjusting R42, the DC level can be set.

The DC level setting is not extremely critical due to the use of a VGA (variable gain amplifier) in the RF modulator. It is important, however, to bias the modulating signal near the center of the VGA gain control input range to optimize the use of the available dynamic range. During Calibration, R42 is adjusted so that 0.85 Volts DC is present on pin 17 of J2 for a 1 kHz tone at 50% modulation. This ensures that the VGA gain control input is biased at its optimum setting.

The modulation level calibration pot, R46, is adjusted during calibration so that a modulation analyzer indicates 50.0% modulation for a 1kHz tone modulating a CW carrier at 156 MHz. An op amp, part of U9, is a simple inverting buffer that produces a positive polarity signal for the percent modulation temperature compensation circuitry on the RF modulation board.

#### **4.5.12 VOLTAGE REFERENCE**

The Voltage Reference U15 provides a stable +5.0 V DC voltage which is used to calibrate and stabilize the NAV 2000R modulation performance. It is used by the Detected Audio Hi/Lo Indication, Audio High/Low Indication, RF Level High/Low Indication, RF level set, % Modulation Centering & Calibration, and Detector Bias networks.

In the Detected Audio Hi/Lo Indication, Audio High/Low Indication, and RF Level High/Low Indication circuits use the voltage reference to calibrate the levels at which the indications will occur. The % Modulation Centering & Calibration circuitry uses the voltage reference to center the DC operating point of the modulating signal. The RF Level circuitry uses the voltage reference to derive a fine tune correction voltage which is then summed with the original voltage reference and fed to the RF leveling loop circuitry on the RF Modulator Board.

#### **4.5.13 DETECTED AUDIO HI/LO INDICATION**

This circuit generates an error signal if the output of the RF detector on the RF modulator board is not within acceptable limits. The error status is presented to the system bus through bus driver U2 and bus transceiver U1.

This window comparator circuit checks the operation of the RF leveling loop and the RF detector and is valid only for a single tone at 50% modulation. It is comprised of two sections of quad comparator U13 and both sections of retriggerable one-shot U17.

When a 50% modulated signal is detected, its positive peak must fall between allowable limits, as set by divider network R51-R53. If the peak is too high or too low, the appropriate detected audio high or low error status will be sent to the system bus.

This circuit is identical to the Modulating Audio High/Low circuit described in Section 4.5.9 except that the limits are not as stringent.

#### 4.5.14 PROGRAMMABLE STEP ATTENUATOR CONTROL

The Programmable Step Attenuator Control consists of a latched relay driver U10 and decoder gating for the strobe input. Each high bit of the latched attenuation word activates one discrete attenuator section. These discrete attenuators consist of 1 dB, 2 dB, 4 dB, 8 dB, 16 dB, 32 dB, and 64 dB pads. The 64 dB attenuation step is actually two 32 dB attenuator sections that are selected together. Otherwise, separate drive lines control each section.

To achieve a given level of attenuation between 0 dB and 127 dB, a combination of the above attenuation values is used. The series resistors R33 through R40 provide the necessary voltage drop from +15 V to +12 V as required by the individual attenuator relay coils. CR1 through CR8 provide a discharge path for the negative current spike when the relay coils of the individual attenuators are de-energized.

To provide 1/10th dBm control, the voltage reference circuit to the modulator is varied using the digital to analog (DAC) device U8 to slew the reference voltage.

#### 4.5.15 RF MODULATOR BOARD

The RF Modulator Board amplitude modulates (AM) a CW RF carrier from an external RF source and provides a leveled RF output. The audio modulation signal that modulates the applied RF carrier is generated by the DSP or an external source module. The audio modulation signal is conditioned by the audio board to achieve RF modulation. The leveling loop ensures that the output of the RF Modulator Board is always at a fixed RF level. Temperature compensation circuitry maintains stable performance over the operating temperature range. The schematic drawing number for the RF Modulator Board is 02-5951-00.

#### 4.5.16 MODULATING SIGNAL TEMPERATURE COMPENSATION NETWORK

The op amp U5A is included in the temperature compensation network for the modulation signal. It is necessary due to the temperature gain dependence of the VGA (Variable Gain Amplifier) gain control input. The slope of the gain control voltage vs. gain changes with increasing temperature: with higher temperature the slope increases.

Suppose 50% modulation using a single tone is achieved at room temperature. After operating the NAV 2000R for several hours in a cabinet, the temperature increases by 25 C. Without temperature compensation, the modulation percentage would become higher than 50%. To compensate for this gain/temperature dependence, a thermistor controls the gain of a non-inverting op amp that is in the signal path of the modulating audio to the VGA gain control input. U5A uses RT1, R28, and R29 to form gain given by

$$G(T) = [1 + [ R29/[RT1(T)+R28] ]$$

where RT1(T) is a function of temperature. If the VGA gain is a function of temperature and input control voltage and is written,

$$G_{vga}(T, V_{agc})$$

then, it follows that the resultant gain be temperature independent if adequate compensation is achieved, or

$$G_{comp}(V_{agc}) = G_{vga}(T, V_{agc}) * G(T) .$$

#### 4.5.17 AUDIO MODULATED AMPLIFIER

The audio modulated amplifier amplitude modulates a CW carrier at its RF input with the audio modulation signal delivered by the Modulating Signal Temperature Compensation network.

The CW carrier at pin 3 of U1 is at a level of about -30 dBm, at RF frequencies from .15 MHz to 450 MHz. Operating the VGA at -29 dBm input minimizes the audio distortion of the modulated output. The required input to the RF Modulator is -20 dBm. After the 9 dB pad, the RF power at the VGA input should be about -29 dBm.

The audio modulating signal applied to the AGC gain control input (U1 pin 8) varies the gain of the amplifier in proportion to the audio signal level, generating amplitude modulation. To optimize the available AGC voltage dynamic range of U1, a DC level, at room temperature of around 0.25 Volts is maintained. This level is adjusted by R42 in the modulating centering circuit on the audio board.

About 0.9 Volts of gain control voltage at U1 pin 8 produces maximum gain (for all temperatures). For 100% positive modulation, the instantaneous peak control voltage, referenced to the DC operating point of will be doubled. The control voltage directly relates to voltage gain so now the peak RF level will be 6 dB above the average RF level. Similarly, for 100% negative modulation, the null of the modulating waveform should extinguish all RF level. This is approximated since the audio modulating signal will, for 100% modulation, swing from .25V to .5V for the peak and from .25V to 0.0V for the null.

With nearly 0.0V applied to the AGC input, there is maximum attenuation of the input CW RF carrier. Although the RF is not completely cut-off, it is adequately attenuated. Decreasing the DC bias point of the modulating signal would be to use less of the linear dynamic range of the VGA. It is important that the VGA be operated in its linear region to avoid audio distortion. Using a lower bias point would mean that the audio signal would need to be smaller and thus noise would become more significant resulting in increased distortion.

There are two RF inputs to the VGA and two RF outputs for balanced operation, if desired. In this application, the RF signal is applied unbalanced with the other input terminated in a 50 Ohm resistor. This termination provides the same impedance as found on the RF input. The output is taken balanced and feeds the RF Leveling Amplifier balanced inputs through a 16 dB pad.

With Vagc, the gain control input, biased at about .25 volts, the average RF power gain should be about 11 dB so that the carrier level of the modulated output is at a level of about -22 dBm.

#### 4.5.18 RF LEVELING AMPLIFIER

The RF leveling amplifier is used to level the output power of the RF Modulator board. Without leveling, the RF level would vary due to the RF frequency response and temperature dependence of the RF circuitry. The leveling amplifier receives a gain control voltage that corrects for differences in output power level from a set level. The leveling loop can correct for output level errors up to +/-5 dB from the set level.

The nominal RF carrier power level received at each of the balanced RF inputs (U2 pins 3 and 5) is about -35 dBm. This input level minimizes audio distortion at the output. The nominal output of the first modulated VGA with a DC bias of 0.25 volts on its Vagc input (U1 pin 8) is about -22 dBm. The 14 dB balanced pad attenuates the signals delivered to each of the inputs of the RF leveling VGA to -36 dBm.

With the RF leveling VGA nominally biased at 0.4 volts (U2 pin 8) the gain will be about 17 dB. Thus, the carrier level at the output will be near the -19 dBm level. For a 100% modulated carrier, this means that the peak will be at the -13 dBm level nominally.

Since variations in gain and frequency response of the three power boosting amplifiers may be as much as 5 dB, the peak of the RF signal level at the output of the RF Leveling VGA could be as high as -8 dBm. This is only 5 dB below the output compression point of this amplifier but has no appreciable effect on distortion.

The RF output, of the RF Leveling Amplifier is single ended. The other output is match terminated in 50 Ohms.

#### **4.5.19 FIXED GAIN AMPLIFIERS**

The two fixed gain amplifiers on the RF Modulator Board boost the nominal RF carrier to 0.0 dBm at the output.

The RF level from U2 is attenuated by a 6 dB pad and will be nominally -25 dBm at the input of the first Fixed Gain Amplifier. Remember, that due to automatic leveling, this level may vary by +/- 5 dB. The first Fixed Gain Amplifier offers about 22 dB of gain with a compression point of about 10 dBm. The uncompensated frequency response should be approximately 1 dB. The nominal output of this amplifier is about -3 dBm. Note that L1 and L2 have been selected to improve the frequency response of the amplifier.

The second Fixed Gain Amplifier offers 9 dB of gain with a +16 dBm 1 dB compression point. The output of this amplifier will have a nominal carrier level of about +6 dBm. At the output of the second Fixed Gain Amplifier, a small portion of the RF power is sent to the Detector and the main power path is attenuated by a 3 dB pad and sent to the RF Modulator Board output connector E2.

At the output of the RF modulator board, the nominal carrier level should be at the -3 dBm level. Note that the programmable step attenuator and output relay network have about -3 dB insertion loss so that there will be a 0.0 dBm carrier level at the output of the NAV 2000R - if no other attenuation is inserted by the programmable attenuator.

#### **4.5.20 DETECTOR**

The Detector circuitry demodulates the RF carrier to provide an audio signal that is independent of temperature and RF frequency. This assures proper operation of the RF leveling and detected audio Hi/Lo circuits. Calibration adjustment is also provided for the detected audio signal, which is used for self-test.

The frequency response and detected audio level temperature dependence are handled by two independent parts of the Temperature Compensated Detector circuitry. The frequency response is leveled over the 25 MHz to 450 MHz range by capacitor C26 and resistor R14.

The temperature compensation circuitry involves CR1, CR2, Q1, and Q2 and is achieved by using the same type diode as the detector, but used in a compensation capacity. With an increase in temperature, the Voltage vs. Current curve of detector CR1 shifts. However, the bias current of CR1 is controlled by CR2, the compensating diode. When the bias point of CR1 changes due to a temperature fluctuation, the bias current provided through CR2 offsets the change. Q1 and Q2 provide the current drive for the network.

Lowpass network L4 and C27 prevent modulated RF from entering the audio circuitry but have negligible effect on the detected audio waveform. R58 and C54 form an additional lowpass filter at the input to U9B. The op amp U9B buffers the temperature compensation circuitry output and provides drive to the audio level processing circuitry.

The calibrated detected audio is provided as an output to the audio board. The calibration of this signal is accomplished using the Detected Audio High/Low circuitry on the Audio Board and is discussed above. The output level is adjusted by pot R44.

#### **4.5.21 LPF & INTEGRATOR**

To obtain a signal, which is proportional to the average RF power level from the detected audio signal, it is necessary to find the average DC level. This is done for all valid audio frequencies above 10 Hz by a lowpass filter and integrator.

Resistor R57 and Capacitor C49 form the first pole of the leveling loop filter. Op Amp U9C buffers this first pole and drives the loop integrator formed by Op Amp U8, Capacitors C45, C46, and C44, and Resistors R48 and R47. The output of U8 drives the voltage control pin (U2-8) of RF amplifier U2.

#### **4.5.22 SCALING & RF LEVEL SET**

The RF level is set and controlled by adjusting the voltage at pin 3 of U8. At output frequencies greater than 25 MHz the leveling loop described above is closed. The high gain of U8 at DC maintains the DC value of the detector output at the voltage set at pin 3. Maintaining this voltage, integration amplifier U8 drives the control pin of RF amplifier U2 to adjust the RF level seen by the detector, thereby fixing the output level of the modulator.

Voltage reference (J1-16) is scaled by resistors R41, R42, R37 and pot R39 to the appropriate detectors voltage. RF level is calibrated by R39. Minor detector frequency response corrections are accomplished by software which adjusts the voltage reference by means of the audio board.

At output frequencies below 25 MHz, the change in output level do to frequency and temperature is minimal. Therefore, the modulator can be ran open loop. Software adjusts the voltage reference to compensate minor frequency response variations, as it does at higher frequencies. To open the leveling loop, control signal DET SEL (pin 4 of J1) is taken high. This disconnects the RF output from the detector using relay K1, reduces the DC gain of U8 to one by connecting across the integrator components with analog switch U7, and selects resistor network R40 and R38 in place of R37. Potentiometer R38 allows changing the voltage reference scaling to calibrate this lower frequency band output level.

The diodes CR3 and CR4 clamp the AGC gain control voltage at a maximum of +1.4 Volts. The gain control input of the leveling VGA gives maximum gain near 1 Volt. Since the negative supply of U9 is ground, the minimum output is just above ground.

#### **4.5.23 RF HIGH/LOW INDICATION**

The RF High/Low Indication circuitry indicates only that the leveling loop is operating within established limits. It does not, however, indicate that the RF output power level is within a certain percentage of the calibrated level. The indication circuitry consists of two window comparators in U6. The leveling loop control voltage is compared to two voltages derived from the voltage reference. The comparison voltages are 80 mV for an RF High indication and 1.05 Volts for an RF Low indication.

If the leveling loop gain control voltage attempts to lower the RF output by developing a voltage of less than 80 mV, "RF level too high" is indicated. Conversely, if the leveling loop gain control voltage attempts to raise the RF output by developing a voltage greater than 1.05 V, "RF level too low" is indicated. Both error indications are +5 VDC.

## 4.6 PROGRAMMABLE STEP ATTENUATOR

The Programmable Step Attenuator provides control over the RF output power level. The output can be switched from 0 dBm to -127 dBm in 0.1 dB steps. It is driven by the Programmable Step Attenuator Control circuitry on the Audio Board.

## 4.7 SYNTHESIZER CIRCUITS

The synthesizer generates a CW frequency at a -20 dBm level in 10 Hz steps from 150 kHz to 450 MHz. To set the synthesizer frequency, the NAV 2000R CPU board first checks the new frequency flag (RAM location 5 of REF/CONTROL board within the synthesizer) to verify that the last frequency loaded has been processed. The new frequency is loaded as a BCD value (LSB=10 Hz) in RAM locations 0 through 3. The new frequency flag is then set. The synthesizer microprocessor, upon seeing the new frequency flag set, reads the new frequency value and converts it into the proper control signal required by the synthesizer circuitry.

Circuits of the synthesizer reside on the REFERENCE/CONTROL board, the RF/OUTPUT board, the MAIN VCO, and the 400 MHz VCO. The REF/CONTROL board generates the frequency standards and the control signals required for selection of NAV 2000R RF frequencies. The RF/OUTPUT board contains the phase lock loop circuitry, dividers, filters and leveling loop circuits required to produce these frequencies. The MAIN VCO covers a frequency range of 225 MHz to 456.25 MHz. The 400 MHz VCO generates a 400 MHz signal when phase locked to the reference. Each board will be covered separately in the following discussion.

### 4.7.1 REFERENCE/CONTROL BOARD CIRCUITS

For the following discussion, refer to the JPN Drawing 02-5852-00 in Section V. Control of the synthesizer is maintained by microprocessor U1. Communication with the NAV2000R main CPU is accomplished by means of RAM U2. This memory may be read or written either by the board microprocessor U1, or by means of the NAV 2000R system buss. This access is time multiplexed. The system buss addressed this memory by placing an address of between 0800h and 1000h on its address buss and pulling the Synthesizer BUS REQUEST line low. Decoder U30 detects this combination and the lack of read or write cycles of the on board processor and outputs a low on pin 14 of U30. This connects RAM U2 address and data bus to the system bus by means of ICs U3, U4, and U29. Inverted by U12, a low on U30-14 produces a high on the J, K not, and CLR not inputs of flip flop U11. The ALE (address latch enable) clocks this flip flop synchronizing the internal bus with the system bus. Seeing BUS GRANT low, the system bus completes its transition. Microprocessor U1 selects RAM U2 by taking P1.0 (U1-1) low. With P1.0 low, either RD not or WR not will enable the outputs of latch U10 and buffer U5. Thus, a read or write is generated to the RAM address selected.

To load a frequency, the microprocessor first outputs data serially to the MAIN PLL located on the RF/OUTPUT board. This is done using three lines, PLL CLK (P2.0), PLL DATA (P2.2), and PLL EN not (P2.2). The values loaded represents the divide ratios required by the main phase lock loop. Then the microprocessor outputs nine discrete controls. Eight are outputted via the microprocessor bus and latched by U6. One is directly controlled using P2.3 of the microprocessors I/O. The eight latched control signals select the proper filter, RF divider, and VCO(s). The last discrete control signal allows stable VCO operation whenever a change in VCO selection is required. Finally, the microprocessor loads the Direct Digital Frequency Synthesizer with values required to produce the proper MAIN PLL reference. The value loaded here is the phase increment required to produce a 700 kHz signal plus or minus (+/-) 1.2 kHz (as required) from the 10 MHz clock.



The Direct Digital Frequency Synthesizer is composed of the DDFS integrated circuit U15, Digital to Analog Converter U16, and low pass filter C13,L1,C14, and L2. The DDFS contains a 32 bit phase accumulator and a phase to sinewave value converter. For each 10 MHz clock cycle, the DDFS IC adds the phase value loaded by the Microprocessor to the previous phase value and outputs the sine value of this new phase to the DAC. The DAC converts this sine value to a amplitude of current. Resistor R12 develops a corresponding voltage. The full scale current is set by resistor R11 and reference voltage source U17. This sampled signal, produced by the DAC, is filtered by the low pass filter to remove the sampling frequency.

The output of the DAC is applied to the gate of transistor Q2. Applied to the source of Q2 is a 10 MHz square wave. This square wave causes Q2 to switch on and off to generate a mixing function, multiplying the 10 MHz and 700kHz. The drain of Q2 is tuned to 10.7 MHz and matches this output to the crystal filter FL1. FL1 is a four pole filter compassed of two cans and coupling capacitor C18. The output of this filter is matched to the input of amplifier transistor Q2 by means of transformer T2. The output of Q2 is matched to 50 ohms by transformer T3. The 10.7 MHz produced is used as the reference frequency for the MAIN PLL on the RF/OUTPUT board.

The synthesizer frequency standard is the Temperature Compensated Voltage Controlled crystal Oscillator (TCVCXO) Y1. The output of this TCVCXO is a 5 volt 10 MHz square wave. The voltage control pin (pin 4) is biased at 2.5 Vdc internally, which corresponds to its center frequency. In operation without an external frequency standard, this input is disconnected by means of analog switch U25. But, when an external standard is connected, this input is controlled within a phase lock loop. Applying a 10 MHz standard at INPUT J6 causes comparator U20 to operate. Seeing this signal, inverter U21 charges C35 through diode CR1. When the voltage on C35 exceeds the threshold voltage of U21 pin 5, the output at U21 pin 6 goes low. The output of comparator U20 is gated to phase comparator U23 and the voltage control pin of TCVCXO Y1 is connected to the output of the loop filter present at Op Amp output U24 pin 1 through analog switch U25. The internal standard is then pulled into phase lock with the external standard, thus moving the reference frequency to that of the external standard. The output of TCVCXO Y1 is buffered by CMOS gates of U22 and U21, and used as clocks for the microprocessor and DDFS, used to drive the 10.7 mixer, and sent to the 10 MHz OUTPUT J7 through transformer T7.

## **4.7.2 RF/OUTPUT BOARD CIRCUITS**

Refer to the JPN schematic 02-5868-00 during the following discussion. The RF/OUTPUT board consists of a MAIN PLL, RF frequency dividers, harmonic suppression filters, a 400 MHz PLL, a Mixer and filter, and output leveling.

The MAIN PLL is used to generate frequencies from 225 MHz to 456.25 MHz. Controlling the MAIN VCOs, the heart of this loop is the PLL IC U3. This PLL IC contains Reference input dividers, a dual modules divide by 64/65 prescaler, dual modules divide by A and N counters, and a digital phase comparator. The PLL IC is programmed by the microprocessor on the REF/CONTROL board. The reference divider is set for divide by 214, producing an internal 50 kHz reference to the phase comparator. With sequential programming of the A and N counters, this produces frequency steps of 50 kHz at the RF frequency. As noted earlier, the NAV 2000R synthesizer has step size of 10 Hz. To produce this smaller frequency step, the 10.7 MHz reference input is shifted up or down in frequency to produce the proper RF

frequency. As an example, consider the 10.7 MHz frequency shift required to shift 321 MHz plus 10 Hz. 321 MHz is 30 times 10.7 MHz. So to shift 321 MHz plus 10 Hz, 10.7 MHz must be shifted by 0.333 Hz or 10/30. The DDS on the REF/CONTROL board can produce this shift to within less than one millihertz. Transistor amplifiers Q1 and Q2 buffer the VCO output to isolate the PLL dividers from the VCO and apply the VCO frequency to the PLL prescaler. The digital phase comparator generates five volt to ground pulses, equal in width as the time due to phase difference between the 50 kHz reference and the divided RF frequency. If the RF frequency is too low, pulses are on OV (pin 4 of U3). If the RF frequency is too high, pulses are on OR (pin 3 of U3). Low pass filter/integrator U1 and surrounding components form the loop filter.

The second output of the MAIN VCO is buffered by transistors Q3 and Q26. The level from these buffers is approximately +10 dBm. At the resistor network composed of R86, R87, R88, and R89, this signal is split, and dropped in level by approximately 4.5 dB and applied to PIN diode switch CR16 and 19 dB to mixer MX1.

PIN diode switch CR16 routes the MAIN VCO output signal to either the RF dividers (U12 and U13) or the PIN diode switch CR5. Diodes CR14 and CR15 and transistor Q27 logic selects routing to the PIN diode switch only when either path of CR5 is selected. Otherwise, the path to the dividers is selected. For output frequencies of 225 MHz to 450 MHz, the path to CR5 is selected. For frequencies of 225 MHz to 310 MHz, the path through the 375 MHz low pass filter is selected. For frequencies of 310 MHz to 450 MHz, the through path via C145 is selected.

For output frequencies between 56.25 MHz and 225 MHz, the MAIN VCO output described above is divided. Between frequencies of 112.5 and 225 MHz, only U12 is enabled. The divided by two output of U12 is routed via PIN diode switches CR1 and CR2 either through the 260 MHz LP filter for output frequencies 155 MHz to 225 MHz, or through the 180 MHz LP filter for output frequencies 112.5 MHz to 155 MHz. Between frequencies of 56.25 and 112.5 MHz both U12 and U13 are enabled. In this case, the divided by four output is routed via PIN diode switches CR2 and CR3 either through the 130 MHz LP filter for frequencies 75.5 to 112.5 MHz, or through the 90 MHz LP filter for frequencies 56.25 to 75.5 MHz.

For output frequencies of 150 kHz to 56.25 MHz, PIN diode switches CR1 - CR6 are off, isolating the MAIN VCO output. To produce this low band of frequencies the 400 MHz PLL operates. The 400 MHz VCO is enabled. The divide by 40 prescaler U11 operates. Phase comparator U10 produces a phase error signal that is filtered by loop filter U9 and its surrounding components. The loop locks, timing the 10 MHz reference at pin 3 of U10 to the divided RF signal at pin 14. Therefore, a 10 MHz times 40 or 400 MHz is generated by the 400 MHz VCO. Buffer transistor Q4 isolates the phase detector from the VCO. Likewise buffer transistor Q5 isolates the Mixer (MX1) from the VCO and the phase detector. This 400 MHz input to the Mixer is at a level of approximately 7 dBm. The MAIN VCO output, reduced to a level of approximately -9 dBm, is applied to the RF input of the mixer. To produce the low band outputs, the MAIN PLL is tuned to 400 MHz plus the output frequency. Therefore, the MAIN PLL outputs frequencies from 400.15 MHz to 456.25 MHz. The output of the mixer is filtered to remove the 400+ MHz signals. Amplified by U14, it then passes through PIN diodes CR12, CR13, and CR7.

The resistor network composed of R104, R105, R106, R107, R108, and R91 combine the selected RF path with other RF paths. It is important to note that only one RF path is selected during any one time. The RF of interest, at a level of approximately 0 dBm, is passed through a 500 MHz LPF to the leveling circuit.

The leveling loop is composed of voltage controlled attenuator AT1, amplifier U20, detector circuits and an error amplifier. Resistor R115, which is tapped off the output of amplifier U20, feeds the detector circuit. Transistors Q22 and Q23 form a fixed current source which biases the hot carrier diode CR11. CR10, the same type diode as CR11, has equal current flowing through it. In this configuration, the voltage variations due to temperature are canceled by the matching diodes with equal currents. The output of this detector circuit, found at the collector of Q22, is buffered by Op Amp U18B and applied to error amp U18A. U18A is configured as an integrating amp. The output of the error amp is feedback to the attenuator, closing the loop. Pot R137 adjusts the output level and is set for an output level of -20 dBm.

Comparators in U17 monitor the control voltage. U17 pin 7 goes low if the control voltage goes below its lower limit. U17 pin 1 goes low if the control voltage exceeds its higher limit.

### **4.7.3 MAIN VCO**

The MAIN VCO board covers a frequency range of 225 to 456.25 MHz. The MAIN VCO consists of four separate selectable VCOs and a common output buffer amplifier. Each VCO covers a portion of this tuning range. The tuning range of each VCO is as follows; VCO1 - 380 to 456.25 MHz, VCO2 - 320 to 380 MHz, VCO3 - 275 to 320 MHz, VCO4 - 225 to 275 MHz. Each VCO is of similar design. The active element is a RF JFET transistor. This transistor is configured as a grounded gate amplifier with a resonant structure on its drain and the output signal coupled from its source. The resonant structure is a microline inductor paralleled with a capacitor and varactor diode. A capacitor produces feedback from the source to the drain. The power supply is isolated by an appropriate inductor and applied to the drain. The tuning line is isolated by a appropriate inductor and common to all four VCOs. The tuning voltage ranges from 4 and 20 VDC with the highest voltage producing the highest frequency. Each VCO has a bipolar switch to apply or remove bias from the JFET transistor's source. The capacitor tapped output is combined by means of 39 ohm resistors to the input of the buffer amplifier. The buffer amplifier is a class A transistor amplifier with the collector biased by a wide band transformer and base biased by two resistors. The output is taken from a center tap of this transformer. The output is split by a resistor network which pads the output to the divider buffers from the main output.

### **4.7.4 400 MHz VCO**

The 400 MHz VCO board as a single VCO similar in design to the VCOs of the MAIN VCO board. The output as likewise buffered by a transistor amplifier of similar design. As was explained previously, this VCO runs only during low band operation (150 kHz - 56.25 MHz). It is always operated at 400 MHz. Its tuning voltage should be approximately 5 VDC.

#### **4.8 REVERSE POWER PROTECTION (-50 UNITS W/MOD STATUS 7 ONLY)**

For the following discussion refer to JPN schematic drawing 02-6157-00. With the POWER switch in the OFF position, relay K101 is in its normally open state. This prevents any damage to the instrument while it is not in use. On power-up, a reset command is issued by the NAV 2000R CPU board to flip-flop U2. U2's output turns on Q1 and Q2 providing drive to relay K101's control pin thereby closing the path between the NAV 2000R output stage and the unit under test.

U1 compares the voltage from the detector circuit composed of R102, CR103 R101 AND C101 to a 2V reference. Should the detected signal exceed the 2V threshold (approx. +20 dBm of RF input), U1's output will change state clearing U2 and opening relay K101. In addition, the CPU board is notified of the tripped condition via the RPPINT discrete output. Maximum trip time is 4 msec. Pin diodes CR103 through CR106 provide high speed protection of the NAV 2000R output by clamping the RF signal to ground until K101 has opened the RF path. K101 will remain open until the RPPRST line is asserted by the CPU board.

**SECTION V  
MAINTENANCE INFORMATION**

**5.1 BILLS OF MATERIALS, ASSEMBLY DRAWINGS, AND SCHEMATICS**

To assist in the maintenance of the NAV 2000R Signal Generator, Bills of Materials, Assembly Drawings, Schematics, and Test Procedures are included in the NAV2000R Maintenance Manual (PN 06-0520-50 for hard copy, E6-0520-50 for CD) available separately from Aeroflex.

**APPENDIX A  
 GPIB COMMAND QUICK REFERENCE**

**GENERAL COMMANDS**

**STATUS**

Command: STAT?

**SET MODE**

Command: MODE=  
 Values: VOR, VORa, LOC, LOCa, G/S, MKR, COM, EMM

**WHAT MODE**

Command: MODE?  
 Values: VOR, VORa, LOC, LOCa, G/S, MKR, COM, EMM

**LOCAL**

Command: LOCAL

**SET DEFAULTS**

Command: DEFAULT

**REVERSE POWER PROTECTION RESET**

Command: RPP RESET

**RF LEVEL**

Command: RF LEVEL= dBm Values: -127 dBm to 0 dBm  
 uV Values: .100 uV to 890 uV (to nearest .1 dBm)  
 mV Values: 1.00 mV to 224 mV (to nearest .1 dBm)  
 Default: - 127.0 dBm

**AUDIO LEVEL**

Command: AUDIO LEVEL=  
 Values: 0 to 1.000 Vrms (0.001 Vrms steps)  
 Default: 0.500 Vrms

**RF FREQUENCY**

Command: RF FREQ=  
 Values: 0.150 MHz to 450.000 MHz (0.00001 MHz steps)

**VOR**

**RF LEVEL**

Command: RF LEVEL=  
 dBm Values: -127 dBm to 0 dBm  
 uV Values: .100 uV to 890 uV (to nearest .1 dBm)  
 mV Values: 1.00 mV to 224 mV (to nearest .1 dBm)  
 Default: -127.0 dBm

**BEARING**

Command: BEARING=  
 Values: 0.00 to 359.99 degrees (0.01 degree steps)  
 Default: 0.00 degrees

**TO / FROM REFERENCE**

Command: VOR REF=  
Values: TO, FROM  
Default: FROM

**AUDIO CONTROL MODE SELECTION**

Command: MODE= VORa  
Values: n/a  
Default: n/a

**30 Hz PERCENT MODULATION**

Command: 30HZ %MOD=  
Values: 0 to 99% (0.01% steps)  
Default: 30.00%

**9960 Hz PERCENT MODULATION**

Command: 9960HZ %MOD=  
Values: 0 to 99% (0.01% steps)  
Default: 30.00%

**1020 Hz PERCENT MODULATION**

Command: 1020HZ %MOD=  
Values: 0 to 99% (0.01% steps)  
Default: 00.00%

**TOTAL PERCENT MODULATION**

Command: TOTAL %MOD=  
Values: 0 to 99% (0.01% steps)  
Default: 60.00%

**30 Hz FREQUENCY**

Command: 30HZ=  
Values: 20.0 to 40.0 Hz (0.1 Hz steps)  
Default: 30.0 Hz

**9960 Hz FREQUENCY**

Command: 9960HZ=  
Values: 9000 Hz to 12000 Hz (0.1 Hz steps)  
Default: 9960.0 Hz

**1020 Hz FREQUENCY**

Command: 1020HZ=  
Values: 10 Hz to 18000 Hz (0.1 Hz steps)  
Default: 1020.0 Hz

**IDENTIFICATION MODE**

Command: IDENT MODE=  
Values: OFF, TONE, CODE  
Default: OFF

**IDENTIFICATION CODE**

Command: IDENT CODE=  
Values: 6 characters of A thru Z, 0 thru 9  
Default: JCAIR

**DOT TIME**

Command: DOT TIME=  
Values: 50 mS to 250 mS (1 mS steps)  
Default: 150 mS

**DASH TIME**

Command: DASH TIME=  
Values: 150 mS to 750 mS (1 mS steps)  
Default: 450 mS

**DOT / DASH SPACE TIME**

Command: DOT DASH SPACE=  
Values: 50 mS to 250 mS (1 mS steps)  
Default: 150 mS

**CHARACTER SPACING TIME**

Command: CHAR SPACE=  
Values: 150 mS to 750 mS (1 mS steps)  
Default: 450 mS

**WORD RATE**

Command: WORD RATE=  
Values: 1.0 to 65.0 seconds (.1 second steps)  
Default: 30.0 seconds

**VORa**

**AUDIO LEVEL**

Command: AUDIO LEVEL=  
Values: 0 to 1.000 Vrms (0.001 Vrms steps)  
Default: 0.500 Vrms

**BEARING**

Command: BEARING=  
Values: 0.00 to 359.99 degrees (0.01 degree steps)  
Default: 0.00 degrees

**TO / FROM REFERENCE**

Command: VOR REF=  
Values: TO, FROM  
Default: FROM

**30 Hz PERCENT MODULATION**

Command: 30HZ %MOD=  
Values: ON, OFF  
Default: ON

**9960 Hz PERCENT MODULATION**

Command: 9960HZ %MOD=  
Values: ON, OFF  
Default: ON



**LOCALIZER****RF LEVEL**

Command: RF LEVEL=  
 dBm Values: -127 dBm to 0 dBm  
 uV Values: .100 uV to 890 uV (to nearest .1 dBm)  
 mV Values: 1.00 mV to 224 mV (to nearest .1 dBm)  
 Default: -127.0 dBm

**DDM**

Command: DDM=  
 Values: .000 to .400 (.001 steps)  
 Default: .000

**LEFT / RIGHT**

Command: LOC REF=  
 Values: LEFT, RIGHT  
 Default: LEFT

**AUDIO CONTROL MODE SELECTION**

Command: MODE= LOCa  
 Values: n/a  
 Default: n/a

**90 Hz PERCENT MODULATION**

Command: 90HZ %MOD=  
 Values: 0.00 to 40.0% (0.01% steps)  
 Default: 20.00%

**150 Hz PERCENT MODULATION**

Command: 150HZ %MOD=  
 Values: 0.00 to 40.00% (0.01% steps)  
 Default: 20.00%

**1020 Hz PERCENT MODULATION**

Command: 1020HZ %MOD=  
 Values: 0.00 to 99.00% (0.01% steps)  
 Default: 30.00%

**TOTAL PERCENT MODULATION**

Command: TOTAL% MOD=  
 Values: 0 to 99% (0.01% steps)  
 Default: 40.00%

**90 Hz FREQUENCY**

Command: 90HZ=  
 Values: 80.0 Hz to 100.0 Hz (0.1 Hz steps)  
 Default: 90.0 Hz

**150 Hz FREQUENCY**

Command: 150HZ=  
 Values: 135.0 Hz to 165.0 Hz (0.1 Hz steps)  
 Default: 150.0 Hz

**1020 Hz FREQUENCY**

Command: 1020HZ=  
Values: 10 Hz to 18000.0 Hz (0.1 Hz steps)  
Default: 1020.0 Hz

**90 / 150 Hz PHASE SHIFT**

Command: PHASE=  
Values: 0 to 359.99 degrees (0.01 degrees)  
Default: 0

**IDENTIFICATION MODE**

Command: IDENT MODE=  
Values: OFF, TONE, CODE  
Default: OFF

**IDENTIFICATION CODE**

Command: IDENT CODE=  
Values: 6 characters of A thru Z, 0 thru 9  
Default: JCAIR

**DOT TIME**

Command: DOT TIME=  
Values: 50 mS to 250 mS (1 mS steps)  
Default: 150 mS

**DASH TIME**

Command: DASH TIME=  
Values: 150 mS to 750 mS (1 mS steps)  
Default: 450 mS

**DOT / DASH SPACE TIME**

Command: DOT DASH SPACE=  
Values: 50 mS to 250 mS (1 mS steps)  
Default: 150 mS

**CHARACTER SPACING TIME**

Command: CHAR SPACE=  
Values: 150 mS to 750 mS (1 mS steps)  
Default: 450 mS

**WORD RATE**

Command: WORD RATE=  
Values: 1.0 to 65.0 seconds (.1 second steps)  
Default: 30.0 seconds

**LOCALIZER AUDIO CONTROL (LOCa)**

**AUDIO LEVEL**

Command: AUDIO LEVEL=  
 Values: 0 to 1.000 Vrms (0.001 Vrms steps)  
 Default: 0.350 Vrms

**DDM**

Command: DDM=  
 Values: .000 to .400 (.001 steps)  
 Default: .000

**LEFT / RIGHT**

Command: LOC REF=  
 Values: LEFT, RIGHT  
 Default: LEFT

**90 Hz PERCENT MODULATION**

Command: 90HZ %MOD=  
 Values: ON, OFF  
 Default: ON

**150 Hz PERCENT MODULATION**

Command: 150HZ %MOD=  
 Values: ON, OFF  
 Default: ON

**GLIDESLOPE**

**RF LEVEL**

Command: RF LEVEL=  
 dBm Values: -127 dBm to 0 dBm  
 uV Values: .100 uV to 890 uV (to nearest .1 dBm)  
 mV Values: 1.00 mV to 224 mV (to nearest .1 dBm)  
 Default: -127.0 dBm

**DDM**

Command: DDM=  
 Values: .000 to .800 (.001 DDM steps)  
 Default: .000

**UP / DOWN**

Command: G/S REF=  
 Values: UP, DOWN  
 Default: UP

**90 Hz PERCENT MODULATION**

Command: 90HZ %MOD=  
 Values: 0.00 to 99.00% (0.01% steps)  
 Default: 40.00%

**150 Hz PERCENT MODULATION**

Command: 150HZ %MOD=  
 Values: 0.00 to 99.00% (0.01% steps)  
 Default: 40.00%

**TOTAL PERCENT MODULATION**

Command: TOTAL% MOD=  
Values: 0 to 99.00% (0.01% steps)  
Default: 80.00%

**90 Hz FREQUENCY**

Command: 90HZ=  
Values: 80.0 Hz to 100.0 Hz (0.1 Hz steps)  
Default: 90.0 Hz

**150 Hz FREQUENCY**

Command: 150HZ=  
Values: 135.0 Hz to 165.0 Hz (0.1 Hz steps)  
Default: 150.0 Hz

**90 / 150 Hz PHASE SHIFT**

Command: PHASE=  
Values: 0 to 359.99 degrees (0.01 degrees)  
Default: 0

**ADF**

**RF LEVEL**

Command: RF LEVEL=  
dBm Values: -127 dBm to 0.0 dBm  
uV Values: .100 uV to 890 uV (to nearest .1 dBm)  
mV Values: 1.00 mV to 224 mV (to nearest .1 dBm)  
Default: -127.0 dBm

**MODULATION MODE**

Command: IDENT MODE=  
Values: CODE, TONE, OFF  
Default: TONE

**MODULATION PERCENT**

Command: ADF %MOD=  
Values: 0.00% TO 99.00% (0.01% steps)  
Default: 95.00%

**MODULATION FREQUENCY**

Command: ADF FREQ=  
Values: 10.0 Hz to 18000.0 Hz (0.1 Hz steps)  
Default: 1000.0 Hz

**MARKER BEACON**

**RF LEVEL**

Command: RF LEVEL=  
dBm Values: -127 dBm to 0 dBm  
uV Values: .100 uV to 890 uV (to nearest .1 dBm)  
mV Values: 1.00 mV to 224 mV (to nearest .1 dBm)  
Default: -127.0 dBm

**MARKER BEACON MODE**

Command: MKR MODE=  
Values: OUTER, MIDDLE, INNER  
Default: OUTER

**MODULATION MODE**

Command: IDENT MODE=  
Values: CODE, TONE, OFF  
Default: TONE

**MODULATION PERCENT (OUTER MARKER)**

Command: MKR %MOD=  
Values: 0 TO 99.00% (0.01% steps)  
Default: 95.00%

**MODULATION FREQUENCY**

Command: MKR FREQ=  
Values: 10 Hz to 18000.0 Hz (0.1 Hz steps)  
(outer) Default: 400.0 Hz (pulsed: 2 dashes / second)  
(middle) Default: 1300.0 Hz (Pulsed: 95 dot-dash / minute)  
inner) Default: 3000.0 Hz (Pulsed: 6 dots / second)

**COMMUNICATION**

**RF LEVEL**

Command: RF LEVEL=  
dBm Values: -127 dBm to 0 dBm  
uV Values: .100 uV to 890 uV (to nearest .1 dBm)  
mV Values: 1.00 mV to 224 mV (to nearest .1 dBm)  
Default: -127.0 dBm

**TONE #1 PERCENT MODULATION**

Command: COM %MOD1=  
Values: 0 to 99.00% (0.01% steps)  
Default: 30.00%

**TONE #2 PERCENT MODULATION**

Command: COM %MOD2=  
Values: 0 to 99.00% (0.01% steps)  
Default: 00.00%

**TOTAL PERCENT MODULATION**

Command: TOTAL %MOD=  
Values: 0 to 99.00% (0.01% steps)  
Default: 30.00%

**TONE #1 FREQUENCY**

Command: COM FREQ1=  
Values: 10 Hz to 18000.0 Hz (.1 Hz steps)  
Default: 1000.0 Hz

**TONE #2 FREQUENCY**

Command: COM FREQ2=  
Values: 10 Hz to 18000.0 Hz (.1 Hz steps)  
Default: 2000.0 Hz

**SELCAL**

**RF LEVEL**

Command: RF LEVEL=  
dBm Values: -127 dBm to 0 dBm  
uV Values: .100 uV to 890 uV (to nearest .1 dBm)  
mV Values: 1.00 mV to 224 mV (to nearest .1 dBm)  
Default: -127.0 dBm

**RF ON/OFF**

Command: SCL RF KEY=  
Values: ON, OFF  
Default: OFF

**SELECTIVE CALLING INITIATE**

Command: SCL INIT=  
Values: ACTIVE, INACTIVE  
Default: INACTIVE

**PULSE PERCENT MODULATION**

Command: SCL %MOD=  
Values: 0 to 99.00% (0.01% steps)  
Default: 30.00%

**TONE AMPLITUDE DIFFERENCE**

Command: SCL DIFF=  
Values: -40 to +40 dB (1 dB steps)  
Default: 0 dB

**PULSE #1 CODE**

Command: SCL 1 CODE=  
Values: AA - SS  
Default: AB

**PULSE #2 CODE**

Command: SCL 2 CODE=  
Values: AA - SS  
Default: CD

**PULSE #1 TONE #1 FREQUENCY**

Command: SCL 1 TONE 1=  
Values: 100 to 9999.9 Hz (0.1 Hz steps)

**PULSE #1 TONE #2 FREQUENCY**

Command: SCL 1 TONE 2=  
Values: 100 to 9999.9 Hz (0.1 Hz steps)

**PULSE #2 TONE #1 FREQUENCY**

Command: SCL 2 TONE 1=  
Values: 100 to 9999.9 Hz (0.1 Hz steps)

**PULSE #2 TONE #2 FREQUENCY**

Command: SCL 2 TONE 2=  
Values: 100 to 9999.9 Hz (0.1 Hz steps)

**PULSE #1 TIME**

Command: SCL 1 TIME=  
Values: 0 to 2.000 S (0.001 S steps)  
Default: 1 S

**PULSE #2 TIME**

Command: SCL 2 TIME=  
Values: 0 to 2.000 S (0.001 S steps)  
Default: 1 S

**GAP TIME**

Command: SCL GAP TIME=  
Values: 0 to 999 mS (1 mS steps)  
Default: 500 mS

**TEST FREQUENCY**

Command: SCL TEST FREQ=  
Values: 10 Hz to 18000.0 Hz (.1 Hz steps)  
Default: 1000.0 Hz

**TEST TONE PERCENT MODULATION**

Command: SCL %MOD=  
Values: 0 to 99.00% (0.01% steps)  
Default: 00.00%