

G.709 – The Optical Transport Network (OTN)

Executive Summary

With the growing demand for services and bandwidth and simultaneous decrease in capital budgets, the onus is now on operators to use their existing fiber networks to satisfy the market needs. Since the 1980s, synchronous optical network(ing)/synchronous digital hierarchy (SONET/SDH) has met these needs by providing protection and performance monitoring while supporting a flexible and transparent mix of traffic protocols including Internet Protocol (IP), Fibre Channel, Ethernet, and generic frame procedure (GFP). While the deployment of dense wavelength division multiplex (DWDM) networks during the following decade served to increase existing fiber bandwidth, it severely lacked the protection and management capabilities inherent in SONET/SDH technology.

DWDM deployment also came with a completely new set of network elements (NE), including optical amplifiers, switches, multiplexers, demultiplexers, all of which introduced a sublayer into the network warranting constant monitoring to guarantee fault-free traffic.

The aim of the optical transport network (OTN) is to combine the benefits of SONET/SDH technology with the bandwidth expandability of DWDM. In short, OTNs will apply the operations, administration, maintenance, and provisioning (OAM&P) functionality of SONET/SDH to DWDM optical networks. The OTN is specified in the International Telecommunications Union (ITU-T) G.709 Network Node Interface for the OTN.

This recommendation, sometimes referred to as digital wrapper (DW), takes single wavelength SONET/SDH technology a step further enabling transparent, wavelength manageable multi-wavelength networks. Forward error correction (FEC) adds an additional feature to the OTN by offering the potential for network operators to reduce the number of regenerators used leading to reduced network costs.

The OTN Vision – Properties of the OTN

The aim of the OTN is to enable the multiservice transport of packet-based data and legacy traffic, while DW technology accommodates non-intrusive management and monitoring of each optical channel assigned to a particular wavelength. The “wrapped” overhead (OH) would, therefore, make it possible to manage and control client signal information. Figure 1 illustrates how OTN management capabilities are achieved with the addition of OH at several positions during the transport of the client signal.

OTNs present a number of advantages to network operators including:

- Protocol transparency
- Backward compatibility for existing protocols
- Allowance of FEC coding
- Reduction in 3Rregeneration (through flexible optical network designs)

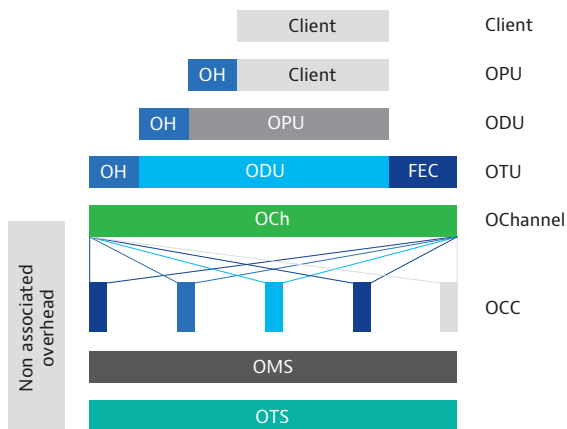

Figure 1: Basic OTN transport structure

The last point is of particular significance as it minimizes network complexity which leads to reduced costs.

Several overhead sections are added to the client signal which together with the FEC form the optical transport unit (OTU). This is then carried by a single wavelength as an optical channel (OCh). As multiple wavelengths are transported over the OTN, an overhead must be added to each to enable the management functionality of the OTN. The optical multiplexing sections and optical transmission sections are constructed using the additional OH together with the OCh.

Figure 2 illustrates Reamplify – Reshape – Retime (3R) 3R regeneration which occurs on the OTN ingress Interdomain interface (IrDI). The transport through the network may take place solely in the optical domain. A point to note, however, is that currently no management capabilities exist for dealing with optical signals that have not been converted to digital format. In contrast to the transparent network, the opaque network performs a 3R regeneration at each node in the network.

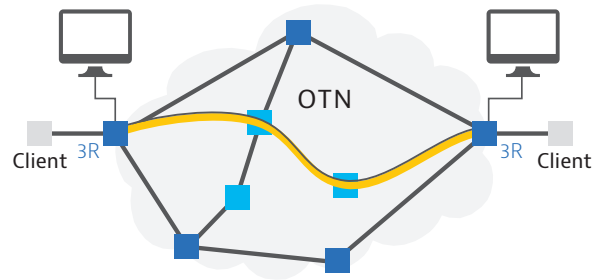

Figure 2: OTN network

ITU-T G.709 Standards for OTNs

The ITU-T G.709 standard, network node interface for the OTN, defines the OTN IrDI in the following ways:

- Functionality of the overhead in preparing the multiwavelength optical network
- OTU framing structure
- Bit rates and formats permitted for mapping of the clients

Two types of interface are described in the ITU-T G.872 recommendation architecture of the OTNs, the locations of which Figure 3 illustrates.

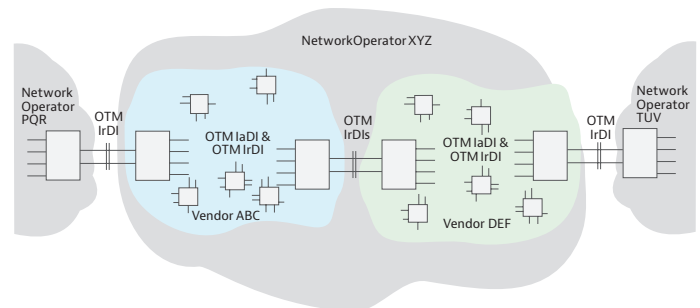

Figure 3: ITU-T G.872 definition of network interfaces

Inter-Domain Interfaces

IrDI define:

- The location between the networks of two operators
- The location between the subnetworks of two vendors in the same operator domain
- The location within the subnetwork of one vendor

Intra-Domain Interfaces

Intra-domain interfaces (IaDI) defines:

The location between the equipment of an individual manufacturer’s subnetwork

The basic OTN layers are visible in the OTN transport structure and consist of the OCh, optical multiplex section (OMS), and optical transmission section (OTS), as shown in Figure 4.

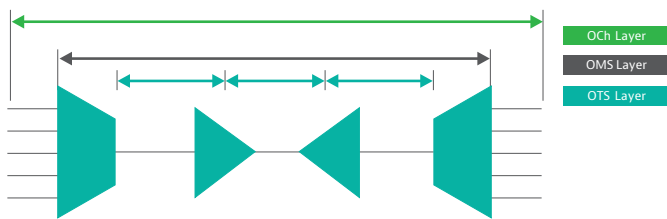

Figure 4: OTN layer structure; as with SONET/SDH, the OTN has a layered structure design

Transport of a client signal in the OTN follows the procedure outlined below and in Figure 5:

- OH is added to the client signal to form the optical channel payload unit (OPU)
- OH is then added to the OPU thus forming the optical channel data unit (ODU)
- Additional OH plus FEC are added to form the OTU
- Adding further OH creates an OCh, which is carried by one color
- Additional OH may be added to the OCh to enable the management of multiple colors in the OTN. The OMS and the OTS are then constructed. The result is an OCh comprising an OH section, a client signal, and a FEC segment, as Figure 6 shows.

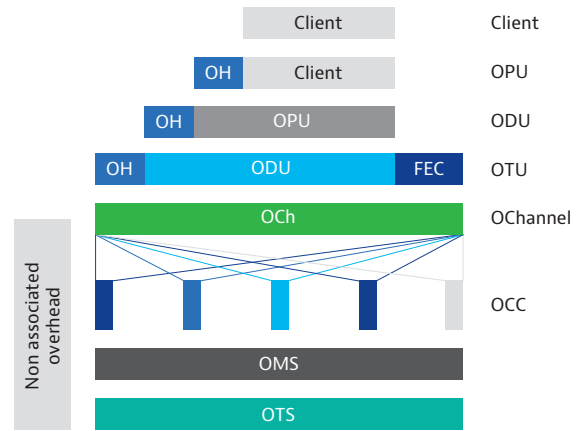

Figure 5: Basic OTN transport structure

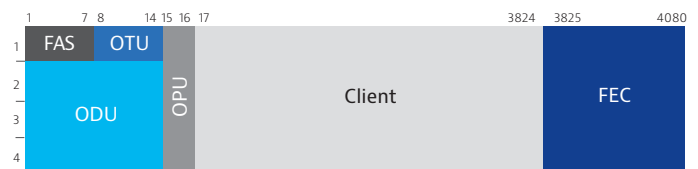

Figure 6: Optical channel structure consisting of OH bytes, client, and FEC

The OCh OH, which offers the OTN management functionality, contains four substructures: the OPU, ODU, OTU, and frame alignment signal (FAS).

OTU OH and Frame Alignment

The OTU is used in the OTN to support transport via one or more optical channel connections. It also specifies both frame alignment and FEC, as shown in Figure 7.

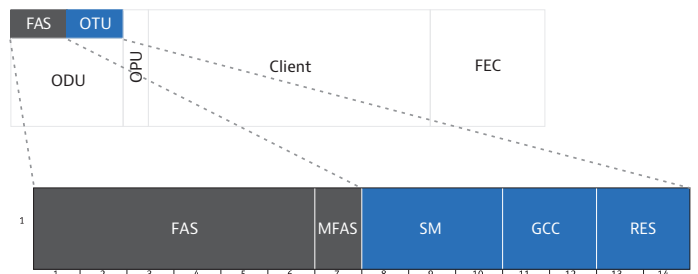

Figure 7: Frame alignment and OTU OH structure

The **frame alignment OH**, which is part of the OTU OH, is situated in row 1, columns 1 to 6 of the OTU in which a **FAS** is defined, as Figure 7 shows. As the OTU and ODU frames could span multiple OTU frames, a multiframed, structured overhead signal is defined. The **multiframe alignment signal (MFAS)** is defined in row 1, column 7 of the OTU/ODU overhead. The value of the

MFAS byte increments with each OTU/ODU frame, as Figure 8 shows.

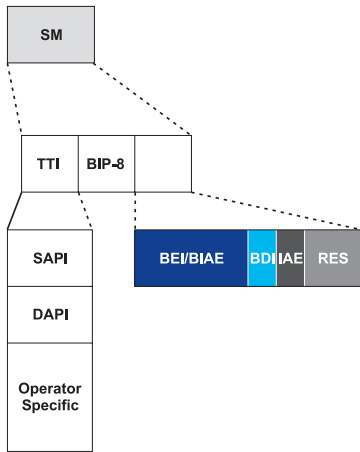

Figure 8: Section monitoring OH

The **section monitoring (SM) OH** consists of the subfields as described for the path monitoring OH, with the exception of the incoming alignment error (IAE) bit. This bit allows the ingress point to inform the egress point that an alignment error in the incoming signal has been detected. IAE is set to “1” when an error occurs, otherwise it is set to “0”.

General communication channel 0 (GCC0) is used as a communication channel between OTU termination points.

The **client signal** – or actual payload to be transported – could be of any existing protocol, that is: SONET/SDH, GFP, IP, GbE, as shown in Figure 9.

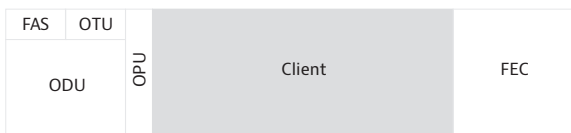

Figure 9: Client in an optical channel

The **OPU OH** is added to the OPU payload and is used to support the various client signals. It regulates the mapping of the many client signals and provides information on the type of signal transported. The ITU-T G.709 currently supports asynchronous as well as synchronous mappings of client signals into the payload, as shown in Figure 10.

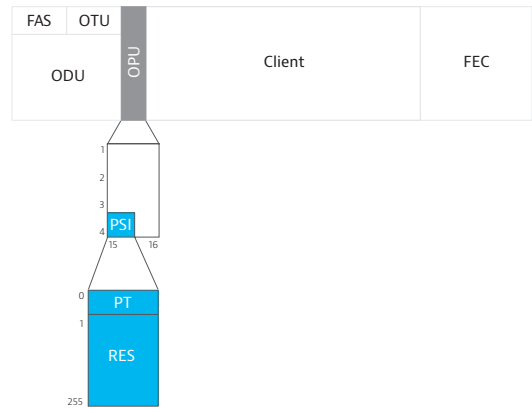

Figure 10: Overhead of OPU

The OPU OH consists of the payload structure identifier (PSI) which includes the payload type (PT) and overhead bits associated with the mapping of client signals into the payload, such as the justification bits required for asynchronous mappings.

The OPU OH is then terminated at the point where the OPU is assembled and disassembled.

The **OPU PSI** field transports a 256-byte message aligned with the ODU multiframe. PSI0 contains the PT, which identifies the payload being transported. The **OPU** is a single byte defined within the PSI that indicates the composition of the OPU signal, or the type of payload in the OPU is carrying, see Figure 11.

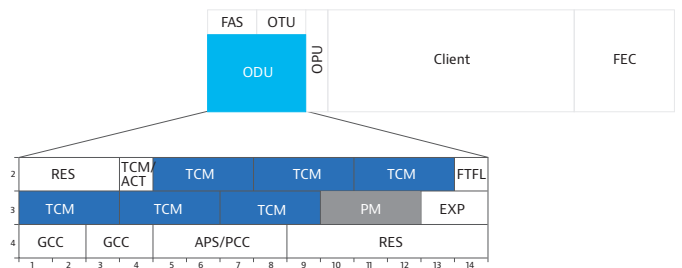

Figure 11: Overhead structure of ODU

The **ODU OH** allows the user to support tandem connection monitoring (TCM), path monitoring (PM) and automatic protection switching (APS). End-to-end path supervision and client adaptation is made possible via the OPU (as described previously). The ODU OH provides two important overheads: the PM overhead and the TCM.

The **ODU PM OH** enables the monitoring of particular sections within the network as well as fault location in the network via the overhead bytes described in the PM OH, shown in Figure 12.

The PM OH is configured in row 3, columns 10 to 12 to support PM. The PM field structure contains the following subfields:

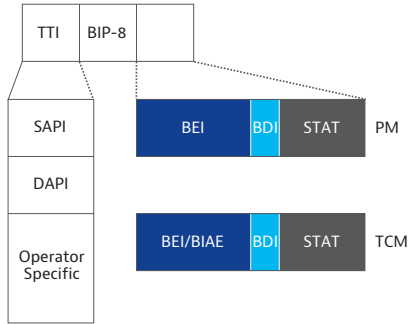

Figure 12: TCM and PM overhead structures

- **Trail trace identifier (TTI)**

The TTI is similar to the J0 byte in SONET/SDH, which is used to identify the signal from the source to the destination within the network. The TTI contains the access point identifiers (API), which are used to specify the source (SAPI) and destination access point identifiers (DAPI). The APIs contain information regarding the country of origin, network operator, and administrative details.

- **Bit interleaved parity (BIP-8)**

This byte, used for error detection, provides a BIP-8 code, computed over the whole OPU and inserted into the BIP-8 SM two frames later.

- **Backward defect indication (BDI)**

The single bit BDI conveys information upstream regarding signal failure.

- **Backward error indication (BEI) and backward incoming alignment error (BIAE)**

The BEI and BIAE signals carry information upstream on interleaved bit blocks detected in error and are also used to convey incoming alignment errors (IAE) upstream.

- **Status bits for indication of maintenance signal (STAT)**

The three STAT bits indicate the presence of maintenance signals.

ODU TCM OH

Two particular functions implemented in SONET/SDH networks are TCM, which enables signal management across multiple networks, and hierarchical error checking, which can be performed using the parity bytes. In addition to these, G.709 also allows for signal management functions, such as those found in wholesale wavelength services.

The TCM OH bytes are defined in OH row 2, columns 5 to 13 as well as in ODU OH row 3, columns 1 to 9. Each TCM field contains the subfields – as already described under PM – with additional BIAE. The TCM functionality implemented in the OTN can monitor up to six tandem connections independently. TCM allows for the nesting and overlapping of ODU monitoring connections.

As illustrated in Figure 13, monitoring occurs between A1-A2, B1-B2, and C1-C2 in nested mode. With B1-B2, monitoring only occurs in cascaded mode. Carriers could potentially use these functionalities to maintain their own service level agreements (SLAs) within their networks. Additional ODU OH bytes are described next.

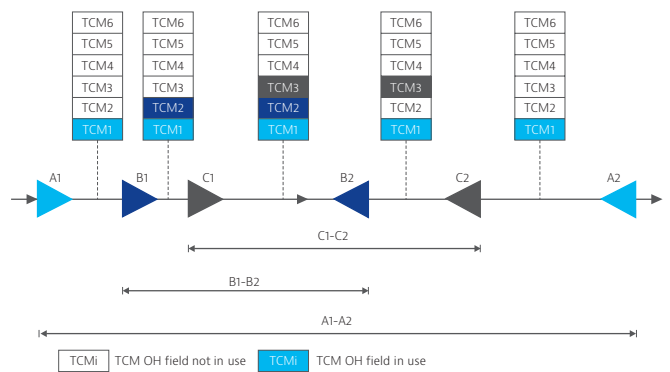

Figure 13: Possible TCM structure in an OTN

- **Reserved (RES)**

Bytes reserved for future international standardization. All bytes are set to zero, as they are currently not in use.

- **TCM/ACT**

A one-byte field used for the activation and deactivation of the TCM fields. At present, these fields are still being studied.

- **Experimental (EXP)**

Bytes reserved for further experimental use.

- **General communication channels (GCC1, GCC2)**

Two fields that allow communication between two NEs with access to the ODU frame structure.

- **Automatic protection switching and protection communication channel (APS/PCC)**

Makes APS on one or more levels possible.

- **Fault type and fault location channel (FTFL)**

A byte in the ODU OH reserved for the FTFL message and provides fault status information, including fault type as well as location. The FTFL is related to the TCM span, Figure 14 shows.

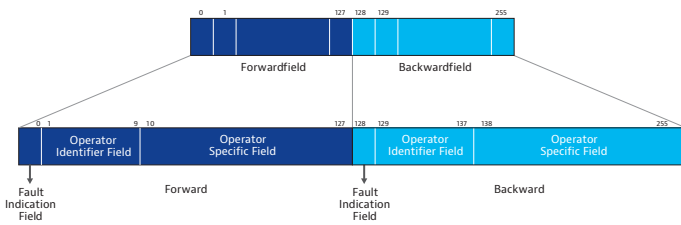

Figure 14: Structure of the FTFL field with its corresponding substructure

The substructure contains: forward and backward-fault-type indication fields, forward/backward operator identifier fields, and forward/backward operator specific fields that perform the following functions:

The fault-type indication field

The codes specified thus far indicate the following situations:

- No fault
- Signal fail
- Signal degrade

Additional bytes in the FTFL message field are reserved for future international standardization.

Operator-identifier field

A field that specifies the geographic origin of the operator and includes a national segment field.

Operator-specific field

The ITU-T G.709 recommendations do not standardize these fields.

Forward Error Correction

In conjunction with the OCh OH of the digital wrapper envelope, additional bandwidth is added—in this case FEC. The implemented algorithm/FEC enables the detection and correction of errors in an optical link as Figure 15 shows.

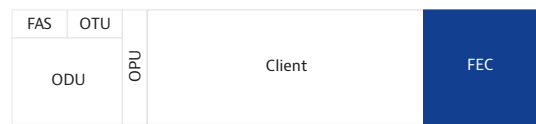

Figure 15: FEC structure of the OCh

Under-sea cable operators already widely use FEC in various designs. Also several algorithms/codes can be used in performing error correction.

The FEC implementation defined in the G.709 recommendation uses the Reed-Solomon code RS (255, 239). Here, an OTU row is split into 16 sub-rows each consisting of 255 bytes. The sub-rows are formed with byte interleaving, meaning that the first sub-row consists of both the first OH byte and the first payload byte. The first FEC byte is inserted into byte 240 of the first sub-row, which is true for all 16 sub-rows, as Figure 16 shows.

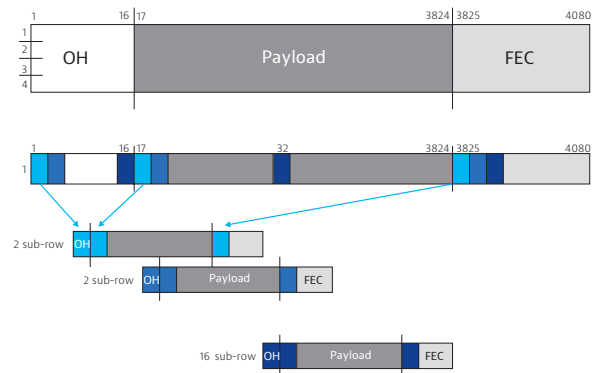

Figure 16: Illustration of Reed-Solomon coding in the G.709 recommendation

Of these 255 bytes, 239 are used to calculate the FEC parity check, the result of which is transmitted in bytes 240 to 255 of the same sub-row, which is shown in Figure 17.

The Reed-Solomon code can detect 16 bit errors or correct 8 bit errors in a sub-row. The FEC RS (255, 239) is specified for the fully standardized IrDI. Other completely standardized OTUkV interfaces (for example, laDI), which are only functionally standardized, may use other FEC codes.

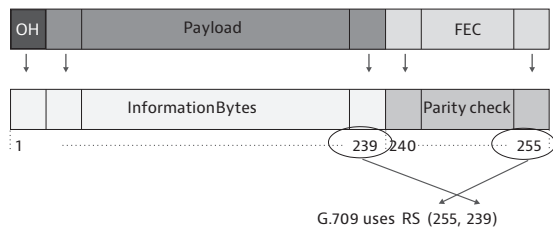

Figure 17: Forming of parity check

The Case for Using FEC in Optical Networks

FEC enables the detection and correction of bit errors caused by physical impairments in the transmission medium. These impairments are categorized into linear (attenuation, noise, and dispersion) and nonlinear (four-wave mixing, self-phase modulation, and cross-phase modulation) effects. When FEC is used in a network link, the network operator can accept a lower quality signal in the link to correct potential errors. The chart shown in Figure 18 illustrates the effect of an increase in signal quality in three cases. In one case, no FEC. The remaining two cases, use FEC but with different coding algorithms.

In this instance, an input bit error rate (BER) of approximately 10^{-4} can be improved to an output BER of about 10^{-15} , in the best case scenario. However, the output BER shows no improvement when an FEC algorithm is not used.

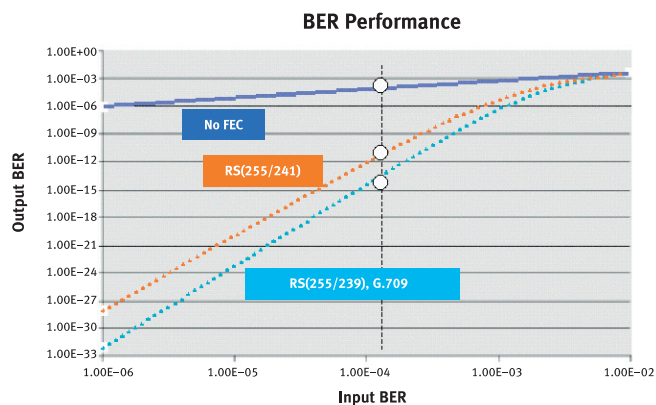

Figure 18: Effect of using FEC with various algorithms

The Benefits of FEC in Optical Networks

The potential improvement in signal quality in an optical link offers many advantages including:

- Power level gain of approximately 5 dB, which is achieved when using 7 percent FEC (correlating to a link expansion of approximately 20 km).
- Reduction in the use of 3R regenerators, which is made possible by increasing the distance between links.
- Use of existing 2.5 Gbps links to transport 10 G traffic, which has been attempted and could be made possible given that FEC allows for the correction of the lower signal quality.
- Early warning capabilities. Some NEs monitor corrected errors in links. This parameter could, in turn, be used as an early warning tool, whereby the amount of errors corrected in a link could signify the weakening of a component in the link itself.

Once the optical channel is formed, additional non-associated OH is added to individual OCh wavelengths, which then form the OMS and OTS, as in Figure 19.

Both the OMS payload and non-associated overhead (OMS-OH) are transported in the OMS layer. The OMS payload consists of multiplexed OChs. The OMS-OH, although undefined at this point, is intended to support the connection monitoring and assist service providers in troubleshooting and fault isolation in the OTN.

The **OTS** layer transports the OTS payload as well as the OTS-OH.

Similar to the OMS, the OTS transports the optically multiplexed sections described previously. Although not fully defined, the OTS-OH is used for maintenance and operational functions. The OTS layer allows the network operator to perform monitoring and maintenance tasks between the NEs, including optical add/drop multiplexers (OADMs), multiplexers, demultiplexers, and optical switches.

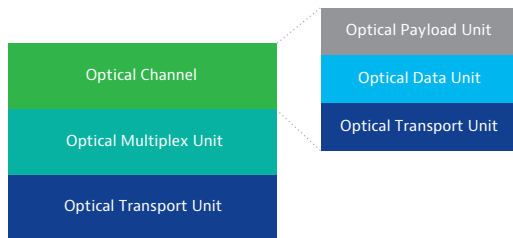

Figure 19: OCh substructure and basic OTN structure

FEC Measuring Applications

The OTN provides extensive OAM&P functionality for multiple wavelengths and, thus, requires an extensive OH. To guarantee transmission bandwidth availability and quality in the network, the OH bytes must be monitored. In addition to monitoring the status of these OH bytes, the system must be checked under stress.

This procedure is executed mainly by introducing alarms and errors into the system and then measuring their effect on the transmission.

The DW technology and OTN-implemented FEC are relatively new technologies offering related applications for use in research and development (R&D). Measurement applications in production and installation are already either in use or planned for use in the near future. Tests in R&D, production, and installation are mostly functional and cover:

- Signal integrity testing (optical power, ability of the device under test [DUT] to synchronize on the frame, and further parameters)
- Testing of maintenance signals – alarm testing
- Error insertion in the test signal
- Mapping testing of the OTUk (for example, mapping of a SONET/SDH structure into the OTUk)
- Multiplex testing of the OTUk (for example, multiplexing of an ODM1 into an ODU2)
- G.709 OH testing (for example, test of section monitoring, path monitoring, and FTFL)
- Interoperability, in which TCM testing is required

- FEC testing
- Stimulation of NEs with anomalies (for example, alarms and errors)

Stimulus Testing

The measuring equipment sends a stimulus to the DUT and monitors the return signal. The signal received must correlate with the stimulus. If the two signals do not match, the user then receives information about the DUT allowing for further investigation.

Possible stimuli could include the standard OTN errors and alarms defined in the G.709 recommendations, as Figure 20 shows.

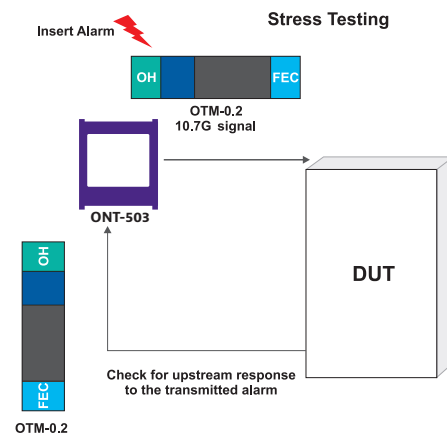

Figure 20: Setup for stimulus testing

Mapping and Demapping of Client Signals

The OTN framing structure makes the mapping of a variety of traffic types into OPUs possible, which includes SONET/SDH (STM-256) into OPU3, ATM cells into the OPU, and GFP frames into the OPU.

Rate differences between the client and the OPU, of course, must be adjusted. This test is also extremely useful as either synchronous or asynchronous mappings are required for the various client mappings. In order to perform this measurement, the DUT transmits a signal with varying range which is then mapped into the OPU. The receiver can then detect whether the client has been properly mapped into the OPU, as Figure 21 illustrates.

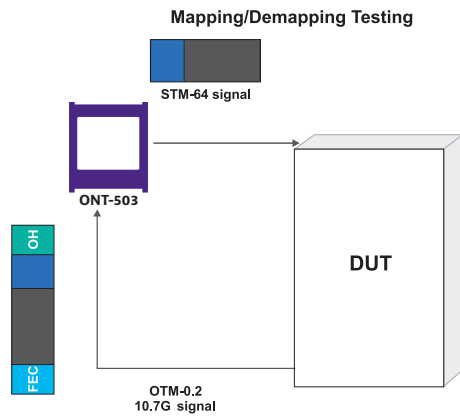

Figure 21: Conducting mapping and demapping tests

FEC Testing

In order to carry out full FEC testing, an error is inserted into the OCh and is then transmitted through an OTN NE. At the receiving end, the OCh is checked to determine whether the DUT corrected the error. This test is performed by inserting varying numbers of errors and allowing the user, in turn, to check the error correcting capability of their NE. If the number of errors inserted exceeds the correction capability of the NE, the measuring equipment will reflect uncorrectable error (s), as Figure 22 shows.

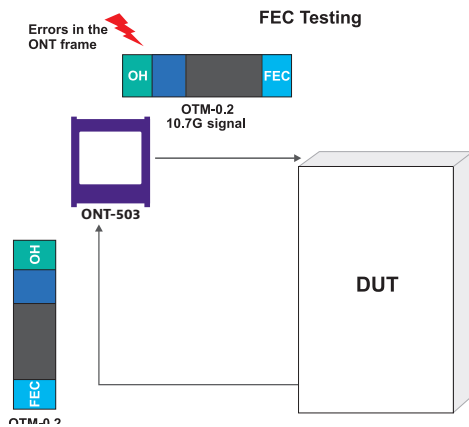

Figure 22: FEC test setup

The Future of OTN

The OTN is intended to provide robust management features that support the high bandwidth in OTNs. The OTN delivers management functionality to DWDM networks, which means that it is capable of managing multiple colors, a function comparable to the effect of SONET/SDH on single wavelengths. The major advantage of the OTN is its full backward compatibility, which makes it possible to build on the existing management functionalities available with SONET/SDH. In addition to this, it provides full transparency of existing communication protocols, such as IP, Packet over SONET (PoS), and GFP.

The OTN and, in particular, the implementation of FEC, lets network operators operate their existing networks both efficiently and economically. Although the G.709 standard describes the basic frame structure and management fields, the network management and the connection setup of optical links in the optical control plane are not yet finalized.

Abbreviations

General abbreviations	
3R	Reamplify – Reshape – Retime
ATM	Asynchronous Transfer Mode
BER	Bit Error Rate
DUT	Device Under Test
DWDM	Dense Wavelength Division Multiplexing
FEC	Forward Error Correction
GFP	Generic Frame Procedure
IaDI	Intra-domain Interface
IrDI	Inter-domain Interface
IP	Internet Protocol
ITU-T	International Telecommunications Union
NE	Network Element
OAM&P	Operations, Administration, Maintenance & Provisioning
OTN	Optical Transport Network
R&D	Research and Development
SDH	Synchronous Digital Hierarchy
SLA	Service Level Agreement

Abbreviations regarding the OTN	
APS	Automatic Protection Switching
BDI	Backward Defect Indication
BEI	Backward Error Indication
BIAE	Backward Incoming Alignment Error
BIP-8	Bit Interleaved Parity-8
DW	Digital Wrapper
EXP	Experimental
FAS	Frame Alignment Signal
FTFL	Fault Type and Fault Location
GCC	General Communication Channel
IAE	Incoming Alignment Error
MFAS	Multiframe Alignment Signal
OADM	Optical Add Drop Multiplexer
OCh	Optical Channel
ODU	Optical channel Data Unit
OH	Overhead
OPU	Optical channel Payload Unit
OMS	Optical Multiplexing Section
OTM	Optical Transmission Module
OTU	Optical channel Transport Unit
OTUk	Functionally standardized Optical Channel Transport Unit-k
OTUkV	Completely standardized Optical Channel Transport Unit-k
OTS	Optical Transmission Section
PCC	Protection Communication Channel
PM	Path Monitoring
PSI	Payload Structure Identifier
PT	Payload Type
RS	Reed-Solomon
RES	Reserved
SM	Section Monitoring
STAT	Status
TCM	Tandem Connection Monitoring
TTI	Trail Trace Identifier

By Andreas Schubert



Contact Us **+1 844 GO VIAVI**
(+1 844 468 4284)

To reach the VIAVI office nearest you,
visit viavisolutions.com/contact

© 2021 VIAVI Solutions Inc.
Product specifications and descriptions in this
document are subject to change without notice.
g709otn-wp-opt-tm-ae
30137534 903 0908