

**SK SERIES  
FIBEROPTIC SWITCH MODULE**

**User's Manual**





## Getting Help

---

For more information, contact JDS Uniphase or your local sales representative.

### **Global Sales and Customer Service**

Hours: 8:00 am - 8:00 pm ET

Phone: 800-498-5378 (Toll Free in North America)

Phone: 800-5378-5378 (Toll Free International)

E-mail Sales: [jdsu.sales@us.jdsu.com](mailto:jdsu.sales@us.jdsu.com)

**[WWW.JDSU.COM](http://WWW.JDSU.COM)**

### **Instrumentation Customer Support and Service**

Emergency technical support is available 24 hours a day, seven days a week:

Phone: 613 843-3000, extension 4999

Canada and U.S.: 1-800-406-9559

China: 10800 140 5599

All Other Countries: International Access Code +800-406-95599

E-mail: [instrumentsupport@jdsu.com](mailto:instrumentsupport@jdsu.com)

Please refer to the JDSU Terms and Conditions of Sale for warranty coverage information.



## Contents

---

<b>Getting Help</b> .....	<b>iii</b>
Global Sales and Customer Service.....	iii
Instrumentation Customer Support and Service.....	iii
<b>Contents</b> .....	<b>v</b>
<b>Safety Instructions and Symbols</b> .....	<b>1</b>
Safety Instructions.....	1
Before Initializing and Operating the Unit.....	1
Operating the Switch .....	1
Safety Symbols .....	2
<b>General Information and Specifications</b> .....	<b>3</b>
General Information .....	3
Single-Common (SK-C) Switch Configuration.....	3
Key Features .....	4
Applications .....	4
Standard Accessories .....	4
Specifications .....	5
<b>Getting Started</b> .....	<b>7</b>
Before Initializing and Operating the Unit.....	7
Initial Inspection .....	7
Operating Environment .....	7
Temperature .....	7
Humidity .....	8
Cleaning Connectors.....	8
Mounting Considerations .....	9
Power Interface Connector .....	9
Fiber Exit.....	11
<b>Operating and Maintenance Instructions</b> .....	<b>13</b>
External Description .....	13
Connections .....	13
Pin Functional Description .....	14
Data Lines (D0 to D6).....	14
/Reset Input Line .....	16
/Strobe Input Line .....	16
Busy Output Line.....	16
Error Output Line.....	16
Timing .....	16
Timing Key .....	17
Calibrating the Switch .....	17
Maintaining the Switch .....	17
<b>Programming Guide</b> .....	<b>19</b>

Testing the Switch.....	19
Programming Examples.....	20
<b>Service .....</b>	<b>21</b>
Storing and Shipping.....	21
Claims and Repackaging .....	21
Returning Shipments to JDS Uniphase .....	21

## Safety Instructions and Symbols

---

### Safety Instructions

The following safety instructions must be observed whenever the unit is operated, serviced, or repaired. Failure to comply with any of these instructions or with any precaution or warning contained in the user's manual is in direct violation of the standards of design, manufacture, and intended use of the unit. JDS Uniphase assumes no liability for the customer's failure to comply with any of these safety requirements.

#### Before Initializing and Operating the Unit

- Inspect the unit for any signs of damage, and read the user's manual thoroughly.
- Install the unit as specified in the **Getting Started** section.
- Ensure that the unit and any devices or cords connected to it are properly grounded.

#### Operating the Switch





	<p><b>Warning</b></p> <p>To avoid the risk of injury or death, always observe the following precautions before initializing the unit:</p> <ul style="list-style-type: none"> <li>• If using a voltage-reducing autotransformer to power the unit, ensure that the common terminal connects to the earthed pole of the power source.</li> <li>• Willfully interrupting the protective earth connection is prohibited.</li> <li>• Never look into the end of an optical cable connected to an optical output device that is operating. Laser radiation is invisible, and direct exposure can severely injure the human eye. For more information, see the user's manual of the laser source in use.</li> <li>• Turning off the power to the device does not always block the externally supplied radiation to the connector at the output of the unit.</li> <li>• Do not use the unit outdoors.</li> <li>• To prevent potential fire or shock hazard, do not expose the unit to any source of excessive moisture.</li> <li>• Do not operate the unit when its covers or panels have been removed.</li> <li>• Do not operate the unit if an interruption to the protective grounding is suspected. In this case, ensure that the unit remains inoperative.</li> <li>• Unless absolutely necessary, do not attempt to adjust or perform any maintenance or repair procedure when the unit is opened and connected to a power source.</li> <li>• Repairs are to be carried out only by a qualified professional.</li> <li>• Do not attempt any adjustment, maintenance, or repair procedure to the</li> </ul>
--	--

	<p>unit's internal mechanism if immediate first aid is not accessible.</p> <ul style="list-style-type: none"> <li>• Disconnect the power cord from the unit before adding or removing any components.</li> <li>• Operating the unit in the presence of flammable gases or fumes is extremely hazardous.</li> <li>• Do not perform any operating or maintenance procedure that is not described in the user's manual.</li> <li>• Some of the unit's capacitors can be charged even when the unit is not connected to the power source.</li> </ul>
--	--

## Safety Symbols

The following symbols and messages can be marked on the unit (Table 1). Observe all safety instructions that are associated with a symbol.

**Table 1: Safety Symbols**

Symbol	Description
	Laser safety. See the user's manual for instructions on handling and operating the unit safely.
	See the user's manual for instructions on handling and operating the unit safely.
	Electrostatic discharge (ESD). See the user's manual for instructions on handling and operating the unit safely.
	Frame or chassis terminal for electrical grounding within the unit.
	Protective conductor terminal for electrical grounding to the earth.
<b>WARNING</b>	<b>The procedure can result in serious injury or loss of life if not carried out in proper compliance with all safety instructions. Ensure that all conditions necessary for safe handling and operation are met before proceeding.</b>
<b>CAUTION</b>	The procedure can result in serious damage to or destruction of the unit if not carried out in compliance with all instructions for proper use. Ensure that all conditions necessary for safe handling and operation are met before proceeding.



# General Information and Specifications

## General Information

This user’s manual for the SK Series Fiberoptic Switch Module contains complete operating instructions.

The SK Series Fiberoptic Switch Module (Figure 1) is a modular 1xN controllable switch. The switch is microprocessor-controlled via a 26-pin parallel interface. It connects a single fiberoptic channel to any of N (up to 26) channels. Small and rugged, the SK Series switch module is designed to be used in embedded applications and is available in both single-mode and multimode versions.

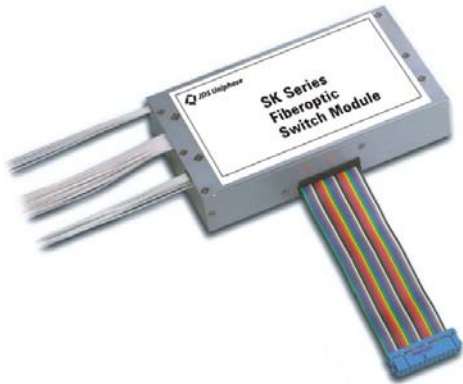

Figure 1: SK Series Fiberoptic Switch

The operation of the switch is based on JDS Uniphase’s proven expanded beam lens technology using a precision stepper motor to align optical channels. The standard single-pole configuration consists of a single common port that can be aligned to any one of 26 ports. In electrical terms, the SK switch is a single-pole, 26-throw switch. The switching mechanism implements collimating lenses that eliminate problems associated with modal noise and provide low insertion loss and high repeatability. The use of collimating lenses minimizes insertion loss and enhances stability and repeatability. The design is optimized for high return loss.

### Single-Common (SK-C) Switch Configuration

Figure 2 shows the single-common C configuration of the switch.

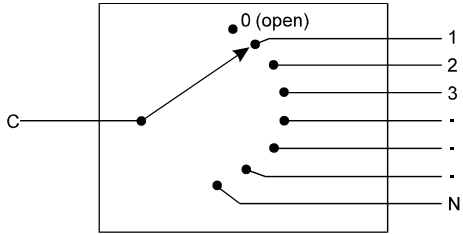

Figure 2: SK-C Switch Configuration

The SK switch operates on a single 5 V  $\pm$ 5% DC power supply and is controlled through a simple parallel interface consisting of seven data lines, a reset line, a strobe line, and a busy line.

### **Key Features**

- Up to 26 channels
- Typical insertion loss 0.4 dB
- Typical return loss 60 dB
- Simple parallel interface control
- Compact modular package suitable for original equipment manufacturing (OEM)

### **Applications**

- Remote fiber test systems in telecommunications networks
- Fiber network restoration
- Subsystem integration
- Test and measurement equipment manufacturing

### **Standard Accessories**

- User's manual

## Specifications

The following optical specifications describe the warranted characteristics of the unit (Table 2). Supplementary specifications describe the typical non-warranted performance of the unit (Table 3).

**Table 2: Optical Specifications**

Parameter	Typical	Maximum
Insertion loss single-mode <sup>1,2</sup> multimode <sup>1,2</sup>	0.4 dB 0.4 dB	0.7 dB 0.7 dB
Return loss single-mode <sup>2</sup> multimode <sup>2</sup>	60 dB 25 dB	55 dB (minimum) 20 dB (minimum)
Polarization dependent loss (single-mode)	0.02 dB	0.05 dB
Insertion loss stability <sup>3</sup>	±0.04 dB	±0.06 dB
Repeatability <sup>4</sup> sequential switching random switching	±0.005 dB ±0.01 dB	±0.02 dB ±0.05 dB
Crosstalk (single-mode)	-90 dB	-80 dB
Input power		300 mW
Switching time one channel <sup>5</sup> each additional channel	75 ms (optical connect time) 15 ms	
Control	7-bit parallel TTL interface with /Strobe, /Reset, busy, error lines	

1 Specifications apply for the single-common configuration.

2 Excluding connectors.

3 Drift of any channel relative to one assigned reference channel at ambient temperature ±3 °C over a seven-day period.

4 Optimum repeatability after one hour warm-up.

5 Time between commands is 120 ms.

**Table 3: Other Specifications**

<b>Electrical</b>	
Input voltage	5.0 ±0.25 V DC typical, 6.0 V DC maximum
Power consumption <sup>1</sup>	2.20 W steady state
<b>Physical</b>	
Dimensions (W x H x D)	79 x 28 x 140 mm
Weight	280 g
<b>Environmental</b>	
Operating temperature	0 to 55 °C
Storage temperature	-40 to 70 °C
Humidity (non-condensing)	maximum 95% RH from 0 to 55 °C

<sup>1</sup> Peak current (while switching) at 0 °C is 4.8 W.

## Getting Started

---

The SK Series Fiberoptic Switch Module consists of the switch and a ribbon cable with a standard dual row connector.

### Before Initializing and Operating the Unit

- Inspect the unit for any signs of damage.
- Read the user's manual thoroughly, and become familiar with all safety symbols and instructions to ensure that the unit is operated and maintained safely.

### Initial Inspection

	<p><b>Warning</b></p> <p>To avoid electrical shock, do not initialize or operate the unit if it bears any sign of damage to any portion of its exterior surface, such as the outer cover or panels.</p>
---	---

Check that the unit and contents are complete:

1. Wear an anti-static wrist strap, and work in an electrostatic discharge (ESD) controlled area.
2. Inspect the shipping container for any indication of excessive shock to the contents, and inspect the contents to ensure that the shipment is complete.
3. Inspect the unit for structural damage that can have occurred during shipping.
4. Connect a 5 V DC power supply to the switch.
5. Turn on the power.
6. Keep the packaging.

Immediately inform JDS Uniphase and, if necessary, the carrier if the contents of the shipment are incomplete, if the unit or any of its components are damaged or defective, or if the unit does not pass the initial inspection.

### Operating Environment

In order for the unit to meet the warranted specifications, the operating environment must meet the following conditions for temperature and humidity.

#### Temperature

The unit can be operated in the temperature range of 0 to 55 °C.

## Humidity

The unit can be operated in environments with up to 95% humidity (non-condensing, 0 to 55 °C). Do not expose it to any environmental conditions or changes to environmental conditions that can cause condensation to form inside the unit.

	<p><b>Warning</b></p> <ul style="list-style-type: none"> <li>• Do not use the unit outdoors.</li> <li>• To prevent potential fire or shock hazard, do not expose the unit to any source of excessive moisture.</li> </ul>
---	---

## Cleaning Connectors

	<p><b>Caution</b></p> <ul style="list-style-type: none"> <li>• Connecting damaged or dirty fibers to the unit can damage the connectors on the unit.</li> <li>• Never force an optical connector. Some connectors have a ceramic ferrule that can easily be broken.</li> </ul>
---	--

Optical cable ends need to be cleaned before using them with the unit.

The following items are required for cleaning:

- Filtered compressed air or dusting gas (for example, Tech Spray Envi-Ro-Tech Duster 1671 gas, available from <http://www.techspray.com/1671.htm>)
- Lint-free pipe cleaners (for example, from 3M<sup>1</sup>) or lint-free swab
- Lint-free towels (for example, 10 x 10 cm or 4 x 4 in HydroSorb III wipers, available from [http://www.focenter.com/acctech/hydrosobr\\_wipers.htm](http://www.focenter.com/acctech/hydrosobr_wipers.htm))
- Optical grade isopropyl alcohol or optical grade 200° ethanol (do not use rubbing alcohol, which contains 30% water)

To clean the connectors:

1. Blow the sleeve with filtered compressed air (Figure 3).

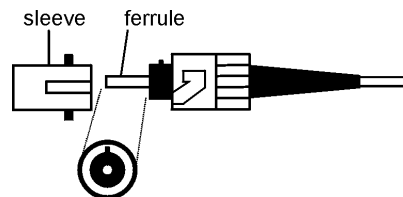

**Figure 3: Connector Cleaning (connector type can vary)**

<sup>1</sup> 3M is a trademark of 3M.

2. Apply optical grade isopropyl alcohol or optical grade ethanol (do not use rubbing alcohol) to a small area of a lint-free towel and rub the end of the ferrule over the wet area.
3. Wipe the ferrule on a dry area of the lint-free towel.
4. Using the dusting gas or compressed air, blow the end of the ferrule.
5. Apply the alcohol or ethanol to a lint-free pipe cleaner or swab and wipe off the remaining parts of the connector.
6. With the other end of the pipe cleaner or swab, dry the areas cleaned.
7. Using the dusting gas or compressed air, blow the areas cleaned.

### Mounting Considerations

The SK switch can be mounted in any orientation. The optical fibers require sufficient clearance to maintain a minimum bending radius of 1.5 cm. This clearance must be maintained around the fiber exit area.

### Power Interface Connector

All electrical connections (parallel interface and power) to the SK switch are made through a standard 26-wire ribbon cable with an attached 26-pin, 0.254 cm (0.1 inch) dual row connector (Figure 4).

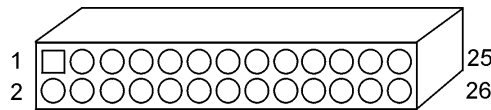

**Figure 4: Dual Row Connector**

The pin assignment is listed in Table 4.

**Table 4: Pin Assignment**

Pin	Signal	Description
1	GND	power ground
2	GND	power ground
3	Busy	busy output: low = idle, high = switching
4	D0	data line 0 input, least significant bit (LSB)
5	Error	reset error output, low = normal, high = switch mechanism position check failed (channel position is verified when the SK switch is reset)
6	D1	data line 1
7		not connected
8	D2	data line 2
9		not connected
10	D3	data line 3
11		not connected
12	D4	data line 4
13	/Strobe	Strobe input, active low: high to low pulse = read data lines and reset line; high pulse = ignore state of data lines and /Reset line. A minimum pulse width of 1 $\mu$ s is required. This line is pulled high internally via 10 K ohm resistor to 5 V DC.
14	D5	data line 5
15		not connected
16	D6	data line 6, most significant bit (MSB)
17		not connected
18	/Reset	Reset input: low sends the switch to the reset position, high returns to channel as specified on data lines
19	GND	power ground
20	GND	power ground
21		not connected
22		not connected, reserved for D7
23	P5V	5 V power in
24	P5V	5 V power in
25		not connected, reserved for 12 V supply input
26		not connected



All transistor-to-transistor logic (TTL) inputs and outputs are pulled high to 5 V DC through 10 K ohm resistors. For inputs, the maximum low level output is 0.8 V, and the minimum high level is 2.0 V. For outputs, the maximum low level output is 0.5 V, and the minimum high level is 4.0 V.

### Fiber Exit

The fibers always exit from the back of the unit (Figure 5), but the order can vary with the unit.

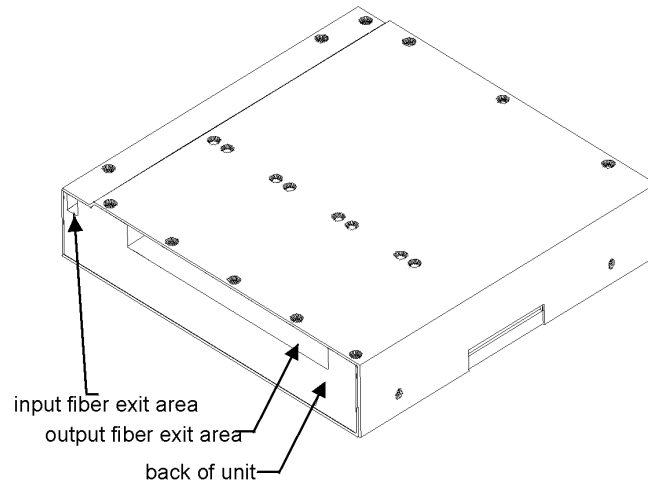

**Figure 5: Fiber Exit**



## Operating and Maintenance Instructions

### External Description

The top and side views of the SK switch module are shown in Figure 6.

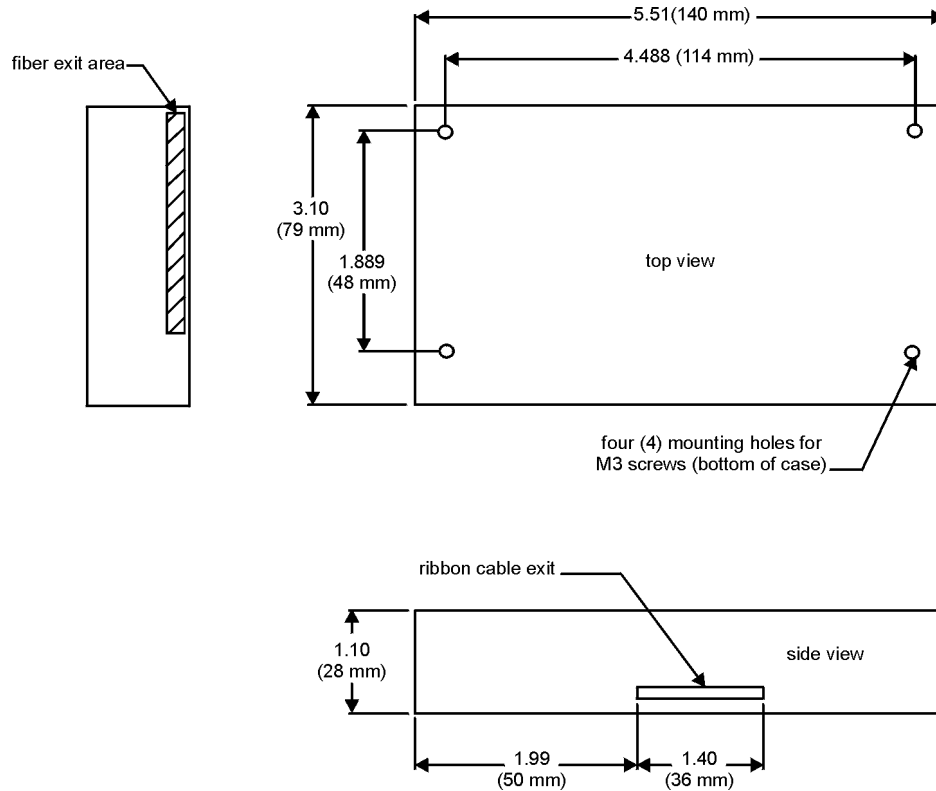

**Figure 6: Top and Side Views of the SK Switch**

### Connections

The way that the SK switch interfaces with the input/output lines of a typical host controller is shown in Figure 7.

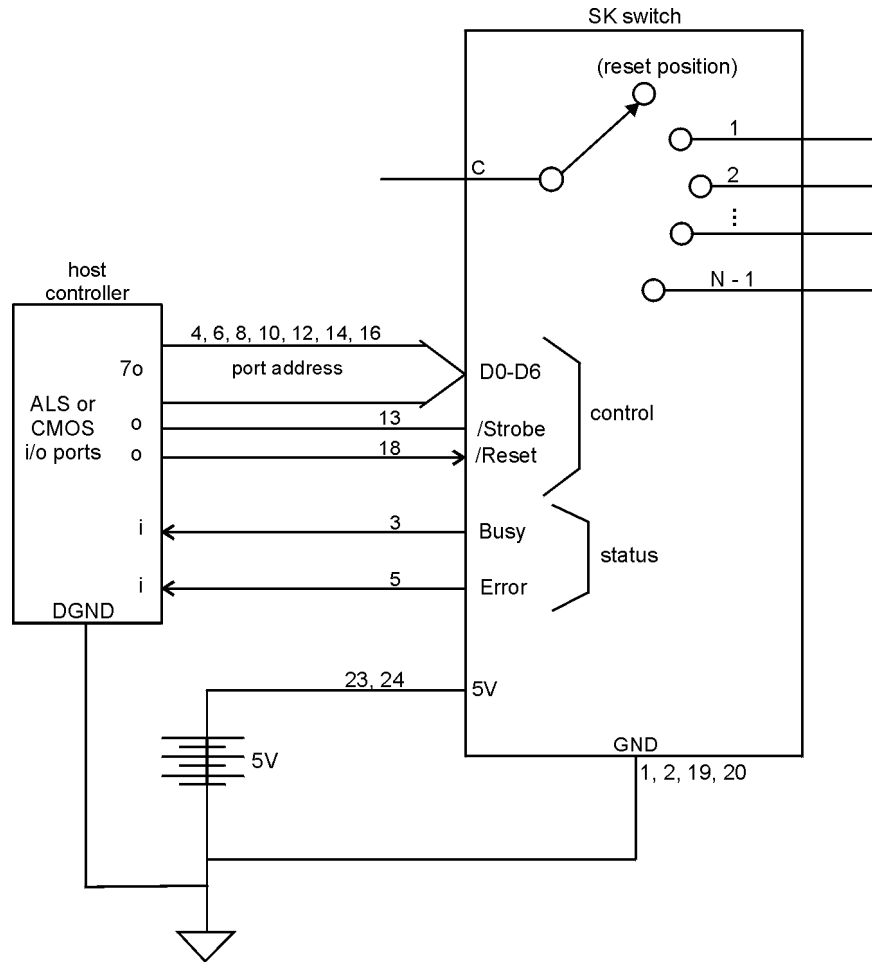

Figure 7: Typical Controller Connections

## Pin Functional Description

### Data Lines (D0 to D6)

Valid channel numbers are strobed in through the data lines on high-to-low transitions of the /Strobe line. When a new channel is strobed in, the SK switch immediately selects the channel. The channel number is represented as a binary number present on the data lines having the values listed in the channel address in Table 5.

**Table 5: Channel Address Table**

<b>/Reset</b>	<b>D6</b>	<b>D5</b>	<b>D4</b>	<b>D3</b>	<b>D2</b>	<b>D1</b>	<b>D0</b>	<b>channel #</b>
0								0 (reset)
1	0	0	0	0	0	0	0	1
1	0	0	0	0	0	0	1	2
1	0	0	0	0	0	1	0	3
1	0	0	0	0	0	1	1	4
1	0	0	0	0	1	0	0	5
1	0	0	0	0	1	0	1	6
1	0	0	0	0	1	1	0	7
1	0	0	0	0	1	1	1	8
1	0	0	0	1	0	0	0	9
1	0	0	0	1	0	0	1	10
1	0	0	0	1	0	1	0	11
1	0	0	0	1	0	1	1	12
1	0	0	0	1	1	0	0	13
1	0	0	0	1	1	0	1	14
1	0	0	0	1	1	1	0	15
1	0	0	0	1	1	1	1	16
1	0	0	1	0	0	0	0	17
1	0	0	1	0	0	0	1	18
1	0	0	1	0	0	1	0	19
1	0	0	1	0	0	1	1	20
1	0	0	1	0	1	0	0	21
1	0	0	1	0	1	0	1	22
1	0	0	1	0	1	1	0	23
1	0	0	1	0	1	1	1	24
1	0	0	1	1	0	0	0	25

The value 0 indicates that the input is set low (for example, <0.8 V DC); the value 1 indicates that the input is set high. For example, to select channel 9, D3 must be set high and the rest of the data lines must be set low.

### /Reset Input Line

The /Reset line overrides the data lines. A low setting on this line forces the SK switch to go to the reset position and verify the previous channel position. /Reset must be strobed in using the /Strobe line. Changes on the /Reset line have no effect until a high-to-low transition occurs on the /Strobe line.

### /Strobe Input Line

The /Strobe line strobes in the data on the data lines to select new channel positions. A change on the data lines has no effect until there is a high-to-low transition on the /Strobe line. The /Reset line also has no effect unless it is held low while the /Strobe line has a high-to-low transition.

### Busy Output Line

The Busy line provides an indication of the switching mechanism state. The line is low when the switch is idle and high when the switching mechanism is moving to another port.

### Error Output Line

The Error line reports the result of the self-test operation that occurs whenever the SK switch is reset. If the test fails, the Error line goes high and stays high until a self-test operation is evoked again (assuming the self-test passes on the next attempt). The error most often indicates a mechanical fault. For more information, contact JDS Uniphase.

### Timing

When a channel address is strobed in from the data lines, the reset command is strobed in from the /Reset line. The Error line goes high if the reset function cannot verify the position of the switching mechanism (Figure 8).

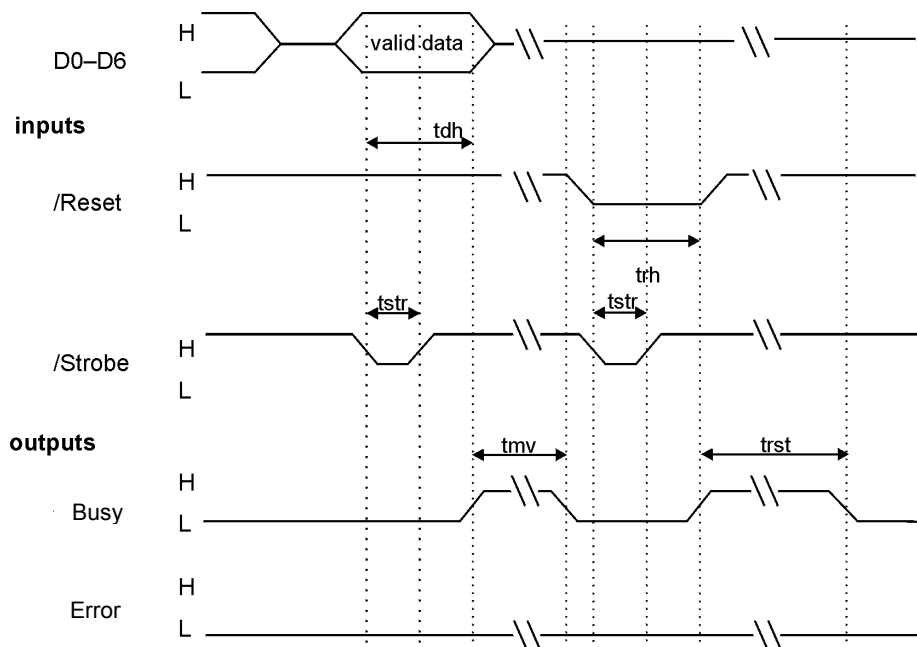

Figure 8: Timing Diagram

## Timing Key

The timing key symbols and values are listed in Table 6.

**Table 6: Timing Key**

Symbol	Minimum	Maximum
tdh, data hold time	20 $\mu$ s	–
tstr, strobe pulse width	1 $\mu$ s	–
tmv, switching cycle time	–	0.55 ms
trh, reset hold time	20 $\mu$ s	–
trst, reset cycle time	–	1.1 s

## Calibrating the Switch

The switch is factory-calibrated. No further calibration is required.

## Maintaining the Switch

Clean all connector ends with a lint-free tissue and alcohol before every mating. See the **Cleaning Connectors** section.





## Programming Guide

---

### Testing the Switch

The SK switch module can be controlled through a PC parallel printer port. An appropriately wired cable is required (Table 7).

**Table 7: SK-Switch-to-PC-Printer-Port-Connection**

From		To	
Line Identification	SK Switch 26-Pin, IDC Connector	Power Supply	Parallel-Port Adapter 25-Pin, D-sub Connector
GND	1	GND	
GND	2		19
Busy	3		11
D0	4		2
Error	5		15
D1	6		3
D2	8		4
D3	10		5
D4	12		6
/Strobe	13		1
D5	14		7
D6	16		8
/Reset	18		9
GND	19	GND	
GND	20	GND	
5 V DC	23	5 V DC	
5 V DC	24	5 V DC	

To test the switch:

1. Connect the switch end of the cable to the SK switch.
2. Connect a 5 V DC power supply to the switch.
3. Turn on the power.
4. Connect the PC end of the cable to the PC.
5. Run the sample program provided in the **Programming Examples** section to select the available channels, and perform a reset test on each one.

## Programming Examples

Run this sample program to select available channels for the SK switch to be controlled through a PC printer port. See the **Testing the Switch** section.

```

1   REM TESTING PROGRAM FOR SK SWITCH THROUGH A PC PRINTER PORT
2   REM OUTPUT DATA PINS ARE AS FOLLOWS:
3   REM (ADDRESS 378H) BIT0-BIT6 CORRESPOND TO DATA0-DATA6
4   REM (ADDRESS 37AH) BIT7=Busy, BIT2=Error
10  DIM SHARED KEYPRESS AS STRING
20  I = 0                                'SET CHANNEL TO 0
30  OUT &H378, I + 128                   'OUTPUT THE CHANNEL SELECTION
40  OUT &H37A, 1                          'SET STROBE LOW
50  OUT &H37A, 0                          'SET STROBE HIGH
60  CLS                                   'CLEAR THE USER SCREEN
62  LOCATE 6, 23
64  PRINT "JDS Uniphase - SK SWITCH TEST"
66  LOCATE 11, 23
68  PRINT "PRESS I TO INCREMENT CHANNEL"
70  LOCATE 12, 23
72  PRINT "PRESS D TO DECREMENT CHANNEL"
74  LOCATE 13, 23
76  PRINT "PRESS R TO Reset AND TEST CHANNEL POSITION"
78  LOCATE 14, 23
80  PRINT "PRESS Q TO QUIT"
82  LOCATE 20, 23
84  PRINT "          "
86  LOCATE 20, 23
88  PRINT "CHANNEL"; I                   'DISPLAY CURRENT CHANNEL
100 STATUS = INP(&H379)                  'CHECK SWITCH STATUS
110 IF (STATUS AND 8) THEN                'CHECK FOR ERROR
120     LOCATE 22, 23                    'DECLARE POSITION ERROR

130     PRINT "POSITION Error DETECTED!"
140 ELSE
150     LOCATE 22, 23
160     PRINT "          "                'CLEAR POS. ERROR STATEMENT
170 END IF
180 STATUS = INP(&H379)                  'CHECK SWITCH STATUS
190 IF (STATUS AND 128) <> 128 THEN GOTO 180 'WAIT FOR BUSY BIT TO CLEAR
200 KEYPRESS = INKEY$                    'CHECK FOR KEYBOARD SELECTION
210 IF KEYPRESS = "Q" THEN GOTO 1000
220 IF KEYPRESS = "I" THEN I = I + 1
230 IF KEYPRESS = "D" THEN I = I - 1
240 IF KEYPRESS = "R" THEN
250     OUT &H378, I                      'OUTPUT THE CHANNEL AND RESET
260 ELSE
270     OUT &H378, I + 128                'OUTPUT THE CHANNEL SELECTION
280 END IF
300 IF KEYPRESS <> "" THEN
310     OUT &H37A, 1                      'SET THE STROBE LINE LOW
320     OUT &H37A, 0                      'SET THE STROBE LINE HIGH
340 END IF
500 GOTO 82
1000

```

STOP

## Service

---

### Storing and Shipping

To maintain optimum operating reliability, do not store the unit in locations where the temperature falls below -30 °C or rises above 60 °C. Avoid any environmental condition that can result in internal condensation. Ensure that these temperature and humidity requirements can also be met whenever the unit is shipped.

### Claims and Repackaging

Immediately inform JDS Uniphase and, if necessary, the carrier, if

- The contents of the shipment are incomplete
- The unit or any of its components are damaged or defective
- The unit does not pass the initial inspection

In the event of carrier responsibility, JDS Uniphase will allow for the repair or replacement of the unit while a claim against the carrier is being processed.

### Returning Shipments to JDS Uniphase

JDS Uniphase only accepts returns for which an approved Return Material Authorization (RMA) has been issued by JDS Uniphase sales personnel. This number must be obtained prior to shipping any material to JDS Uniphase. The owner's name and address, the model number and full serial number of the unit, the RMA number, and an itemized statement of claimed defects must be included with the return material.

Ship return material in the original shipping container and packing material. If these are not available, packaging guidelines are as follows:

1. Cover the front panel with a strip of foam.
2. Wrap the unit in anti-static packaging.
3. Pack the unit in a reliable shipping container.
4. Use enough shock-absorbing material (10 to 15 cm or 4 to 6 in on all sides) to cushion the unit and prevent it from moving inside the container. Pink poly anti-static foam is the recommended material.
5. Seal the shipping container securely.
6. Clearly mark FRAGILE on its surface.
7. Always provide the model and serial number of the unit and the RMA number on any accompanying documentation.

Please contact the RMA department, using the contact information at the beginning of this document, to provide an RMA number and a shipping address.