

# Performance Testing for Multicast Services

## Performance Testing for Multicast Services

Unlike point-to-point network applications, multimedia applications such as data casting (news, stock tickers) and distance learning depend on the ability to send the same information from one server to many users across an IP network.

The purpose of this paper is to introduce procedures specific to testing the performance of multicast networks and services with the VIAVI virtualized network test solution, TeraVM.

The deployment of a multipoint service presents an interesting challenge for service providers, in that they need to understand the performance capability of the underlying infrastructure and its ability to handle multicast flows. In the case of a hosted facility where the source server is deployed as part of a virtual platform, the challenge for the service provider is to define the performance limitations of the virtualized hardware platform's components. In the virtual world all the proprietary hardware for switches, firewalls and routers has been removed, and they now run on a single platform managed by software. Since multicast services tend to be CPU intensive, this can result in key virtual components such as virtual switches becoming bottlenecks as they no longer have the dedicated CPU as per the proprietary solution to deal with possible flood of multicast data.



With multicast services capacity planners face additional challenges when testing the limitations of a network design. Multicast protocols can be taxing on router resources and therefore additional capacity limitations must be quantified. Meanwhile consumers of multicast services expect instant and always on coverage which gives rise to stringent network performance objectives.

## Protocol Overview

Multicast delivers IP packets to a group of endpoints or users on the network. The protocol used varies depending on the IP address type in use. IPv4 will use The Internet Group Management Protocol (IGMP), whereas IPv6 will use Multicast Listener Discovery (MLD).

IGMP/MLD are session-layer protocols used to establish membership in a multicast group - a set of routers and users that send and/or receive multicast data streams from the same source. Routers use three messages to communicate to each other about the availability of multicast traffic.

The endpoint uses the report message to join a new group. Query messages are used to discover which endpoints are members of a given group. Report messages are sent by endpoints in response to queries from a router. Finally, Leave messages are sent when the endpoint wishes to leave a given group.

## Defining test scenarios for multicast services

Multicast services are consumed on a per user basis. The focus for multicast performance testing should be on the complete delivery path or end-to-end. Equally important is to determine if there is any cross talk or impact that a multicast Join or Leave message may have on other users of the service in the same network path. Below are some sample performance questions a service provider should ask; with the focus being on the consumer's Quality of Experience (QoE):

- What is the overall capacity of the network to handle multicast traffic?
- For a number of multicast groups, what is the time to join each group?
- For a number of multicast groups, what is the time to leave each group?
- What is the packet loss rate, while the users are connected to a group?
- What is the throughput with a single multicast group with one user?
- What is the throughput with a single multicast group with 1 million users?
- What is the throughput with many multicast groups with many users?
- What is the throughput with many groups and users with a high rate of Join/Leaves?

## How TeraVM used in performance testing of multicast services

TeraVM is used to emulate the endpoints or users connecting to the multicast service, which provides a controlled and repeatable approach to assessment of the reliability and performance of the network paths when delivering multicast services.

The TeraVM emulated endpoints enable concurrent testing of both IPv4 and IPv6 enabled multicast services, while the per flow performance analysis provides insight on each and every emulated endpoint, on each and every flow joined in the multicast service.

TeraVM's purpose built IGMP/MLD features enable network engineers to quantify all performance aspects in a repeatable and highly flexible manner, the benefits of using TeraVM include:

- Cost effective solution: Supports hundreds of multicast endpoints per test port
- Automated test cases: Automation enables time saving, especially when configuring complex test cases for many-to-many topologies
- Scalability: Rapidly scale from a few tens of users to complete district deployments – emulate 1 million plus endpoints
- Ease of use: Simple to configure service scenarios:
  - One endpoint to one group
  - One endpoint to many groups
  - Many to many
- Performance specific measurements: Multicast specific metrics i.e. Time taken to Join service, time taken to Leave a service, number of packets received after leaving the service, etc
- Network specific measurements: Delay and Jitter
- Detailed reporting packages: Report Packet Loss for the periods when users are valid members of the groups
- Per Endpoint Activity: Assign real-usage behavior per endpoint, with real Join and Leave multicast flow request profiles

To explain these benefits in greater detail, this paper introduces some real world scenarios, which will cover the issues facing multicast service deployments and how TeraVM is used to determine performance and capacity limitations of the network design. Common deployments of TeraVM's network test solutions include:

- Data casting for enterprises
- Performance testing of multicast devices for equipment vendors
- TV / Video multicast service deployment for network operators

Multicast services are rarely deployed on their own, and are usually bundled with voice and data services. Therefore, the performance of multicast services should be analyzed both in isolation and in the context of other network applications. This can be easily achieved by emulation and analysis of common Internet traffic applications.

## Case Scenario: Multicast Video Service deployments

In this scenario, a network operator wishes to deploy multicast video service across the access network.

The platform must support all of the digital TV services that consumers expect, which include picture in picture and digital recording options. Furthermore, the network operator must maintain a high level of performance for existing voice and data services.

In addition to testing multicast video/audio delivery, the network operator needs a methodology in which to prove accuracy of billing systems i.e. the ability to accurately represent real endpoints using genuine login and authentication credentials. This simple requirement emphasizes the need for stateful traffic emulation with per flow performance measurements.

It's worth noting that TeraVM's multicast test functionality is equally applicable for multicast services over DSL, FTTC and DOCSIS network access technologies.

## The Challenge

An example network access device is a DSLAM, serving 2,000 subscribers with voice and data services. A network configuration upgrade will enable multicast routing across the access/aggregation network. However, the video servers are strategically placed at the metro nodes where there is the highest aggregation of user traffic.

As part of the deployment solution VLAN tagging is used to assist with traffic prioritization, with unique VLAN tags per type of service (Voice, Video or Data).

The operator is now faced with a number of challenges, how to rate performance of the network under varying load/usage scenarios:

- 256 Multicast groups with MPEG4 digital streams
- The time required to Leave and Join different multicast groups
- The maximum number of multicast service Leave/Joins supported
- The multicast throughput of the access device with all subscribers connected
- The loss, delay and jitter measurements for the multicast streams

A further challenge operator faces is the ability to reliably repeat the test cases with various user scenarios. In this instance an emulation and performance measurement solution such as TeraVM is required.

In this instance TeraVM is used to emulate the endpoints with real user activity scenarios, in addition TeraVM's per flow performance analysis provides the necessary granular detail to view performance at a network level and at the multicast application level.

## Multicast Video Service Test Scenario and Test Configuration

This section outlines the steps required to emulate and analyze typical multicast sessions for an IP enabled video and content management solution. In the test environment, a high-performance VLAN switch is introduced to reduce the number of test ports required. Without the VLAN switch it would be impossible to scale the test to thousands of emulated subscribers i.e. one test port would be required per each emulated subscriber.

In the configuration below TeraVM is used to emulate the traffic of hundreds of unique users of the service from a single test port. In this instance each emulated user is distinguished by a unique VLAN tag. The switch in turn is configured to process each VLAN stream and disperse the traffic over various Ethernet ports to the DSL modems.

Disaster testing has the effect of increasing the CPU cycles required in the MME, which directly impacts the ability of the MME to manage the SGWs. To determine what impact that excessive redirection requests have on the overall LTE service performance, analysis is done covering the number of packets still arriving to the UE address after the UE handover request has been initiated by the source eNodeB.

## Application-aware metrics

In addition to the network or packet based performance metrics (latency, loss, dropped, etc), there is a need for application focused metrics. For VoLTE call performance is dependent on the SIP configuration. A typical call can have between 9 to 16 SIP messages per session on the signaling plane. Highlighted in the table below are a sample set of UE based metrics which include the SIP messages.

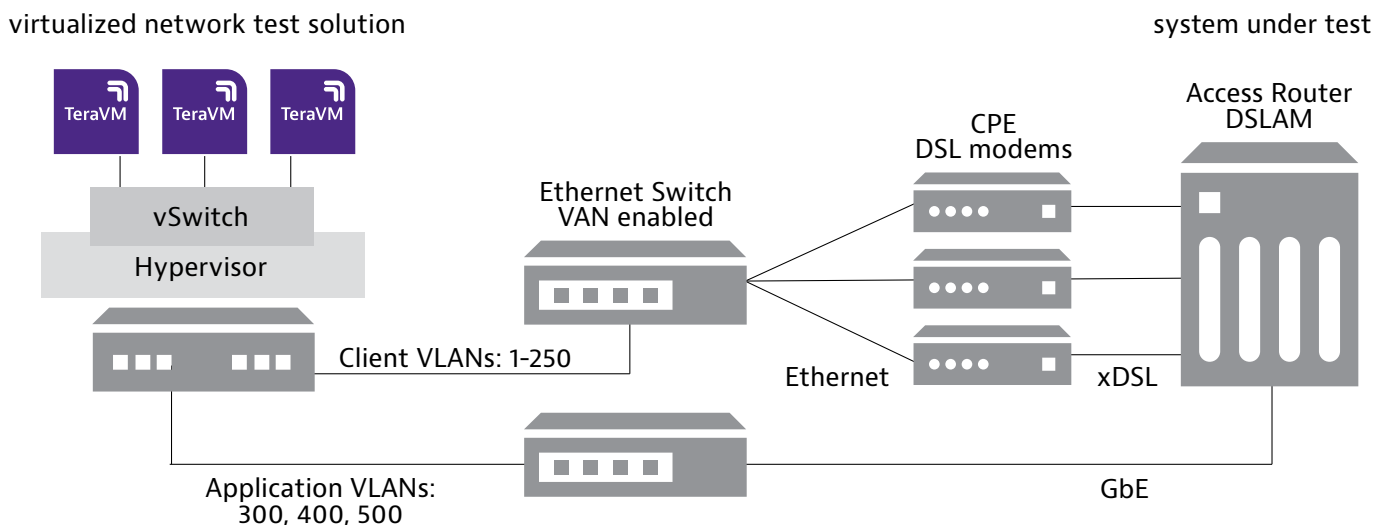

Figure 1: TeraVM's emulated endpoints with unique VLAN tags.

In figure 1 above, the VLAN switch is used to fan out the multicast service requests, enabling users scale the number of residential gateways connecting to the access router with genuine multicast service requests.

Using TeraVM operators can from one central point create reliable and repeatable test scenarios which will load the sample access network, a java based GUI is used to create scaled tests with thousands of emulated multicast service users. The benefit of using the TeraVM GUI is the ease of use when it comes to configuring a large number of subscriber properties. In addition, the simple GUI enables users new to testing multicast services quickly configure tests with the assistance of the wizard or the context-sensitive help. The following is a list of the basic steps required when testing a multicast service in TeraVM:

- Configure the TeraVM test ports with endpoint specific parameters and stateful application traffic requests such as video, voice and data
- Specify the IP address for the client and server side endpoints (if emulating the multicast server).
- Configure the multicast applications e.g. per client side endpoint assign which multicast group the client will Join. In the case were the server side is also being emulated; configure the content to be multicast.
- Run the test and view the results

## TeraVM Per Endpoint Emulation

TeraVM enables users to emulate hundreds of thousands of endpoints in a single test configuration via its easy to use graphical user interface (GUI). The unique emulated endpoints in TeraVM are equivalent to the layer 2-3 properties of a networked device such as a set top box (STB). TeraVM's per flow architecture means each emulated endpoint has unique MAC and IP addresses, enabling scaled testing with multiple unique endpoint configurations per test port, see figure 2.

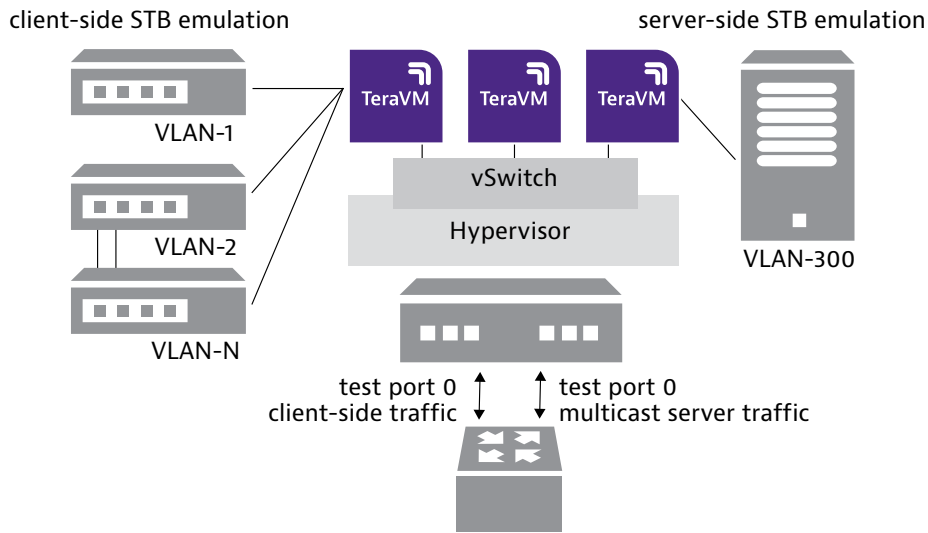

Figure 2: TeraVM enables both client and server side traffic emulation for multicast services

In figure 2 on the client side each emulated endpoint is representative of one end-user's set top box device and is assigned a unique VLAN tag. In addition, each emulated endpoint may be supplied with an IP and a remote gateway address. The IP address represents a virtual router, which is used to create the IP routes for the clients across the device under test (DUT) to the server side.

In the example the gateway address is the IP address of the adjacent network hop. In figure 2 above, VLAN tags 1 to 250 represent the user traffic and VLAN tag 300 is used for all video traffic in the service provider network. Likewise, a different test port and endpoint is used for the Video Server/Content Manager applications. In this case, each service (Voice, Video & Data) or application has its own emulated endpoint with an individual VLAN tag.

TeraVM only requires some basic details in which to present a fully stateful endpoint connecting to the network, IPv4 or IPv6 addressing can be statically or dynamically assigned e.g. (use TeraVM to emulate DHCP and/or PPPoE address servers), in addition TeraVM will automatically assign each endpoint a unique VLAN tag.

### Assigning IP multicast service requests per emulated endpoint

Once the basic layer 2-3 parameters are configured for the emulated endpoints, the next configuration step is to assign the multicast user behavior per endpoint. TeraVM emulates stateful applications, meaning any of the emulated applications can connect with actual live 3rd party servers.

In the case of a multicast service the key configuration parameter is the group IP address for the multicast service. TeraVM enables the flexibility to add more than one multicast group IP address. This enables the user of TeraVM to create test scenarios of real subscriber behavior in which subscribers join new multicast flows.

TeraVM's emulated multicast clients can be configured so as to request a subscription to a specific multicast flow for a period of time. In addition, the test can be automated to skip through a number of multicast broadcasts. In each instance TeraVM provides per endpoint, per multicast flow performance measurements.

The multicast client side application configuration specifies real user behavior of join and leave characteristics for the multicast flows. Options are available for traversing the multicast groups in various manners, including:

- Sequential – joining each multicast group one after the next
- Random – joining any groups available under the test case entry

- Concurrent – joining all of the multicast groups available, at the same time

In addition, the TeraVM configuration can be set to specify the join/leave characteristics, some of the available the options are:

- Never – the client never leaves the group
- After Join – the leave is sent immediately after receipt of the first packet
- After Duration – the leave is sent after a specific duration set on the GUI

TeraVM provides for optional advanced configurations which the option 'Rejoin Delay', in this instance a multicast client which fails to join a multicast group, waits the specified period before attempting to rejoin the failed multicast group. Other optional configurations include the Membership Report count and the interval between reports, it enables users to specify the use of membership report packets to be sent out during the session.

Equally, if a user is testing a device in a closed loop (i.e. TeraVM emulates both client and server side multicast applications) users of TeraVM can configure the multicast server with the address group and the data size and type of data being delivered.

TeraVM's emulated multicast clients can be used to connect to a 3rd party multicast streams, or alternatively TeraVM can be used to emulate the multicast servers for both IGMP and MLD.

### **Multicast service performance measurements**

TeraVM is used to emulate thousands of multicast clients joining and leaving any number of multicast groups, however one of the key benefits of using TeraVM is the ability to analyze performance information live, on a per second basis. In addition to live performance measurements during the test run, performance measurements are also available for post-test analysis.

TeraVM provides dedicated application specific metrics which includes multicast client and server side based metrics. TeraVM performance measurements are available on a per client, per sampling period basis. Using a unique feature of TeraVM it's also possible to monitor network performance using the "Problem Flow Isolation" tools.

The following is a sample set of quality of experience (QoE) based metrics produced by TeraVM specific to multicast:

- Join Latency – Time Joining (Min/Max and Average)
- Leave Latency – Time Leaving (Min/Max and Average)
- Packets received by the client after the leave has been issued
- Packet Loss (while the client is connected to the group)
- Network Latency (Min/Max and Average)

In TeraVM performance graphs can be set to update on a number of sample periods, including per second updates.

Other available measurements in TeraVM include the "number of packets arriving after join message has been sent." For example, how much bandwidth is lost per user per multicast group change request.

## Analyzing results in TeraVM

The following figures demonstrate QoE for a user joining and leaving a multicast group. The scenario covers a single multicast client joining a multicast group and leaving the group and consecutively join/leaving up to ten multicast groups. A key aspect of the emulated behavior is the join duration is for one second and a rejoin delay of five seconds is applied.

The results show that the join is issued at a time  $T=0s$  and the leave is issued 1 second later. Five seconds later the next join occurs. The following analysis windows show that the:

- Average Time Joining – 4.5 ms average (Figure 3)
- Average Time Leaving – 4 seconds average (Figure 4)
- Number of Packets received after Leave – 95 packets/s or 1 Mbps (Figure 5)

During the period after a client is set to be leaving a multicast group address, packets are being received at the client for the previous address group. After a period, the results indicate that no more packets are received, indicating the client has successfully left the multicast group.

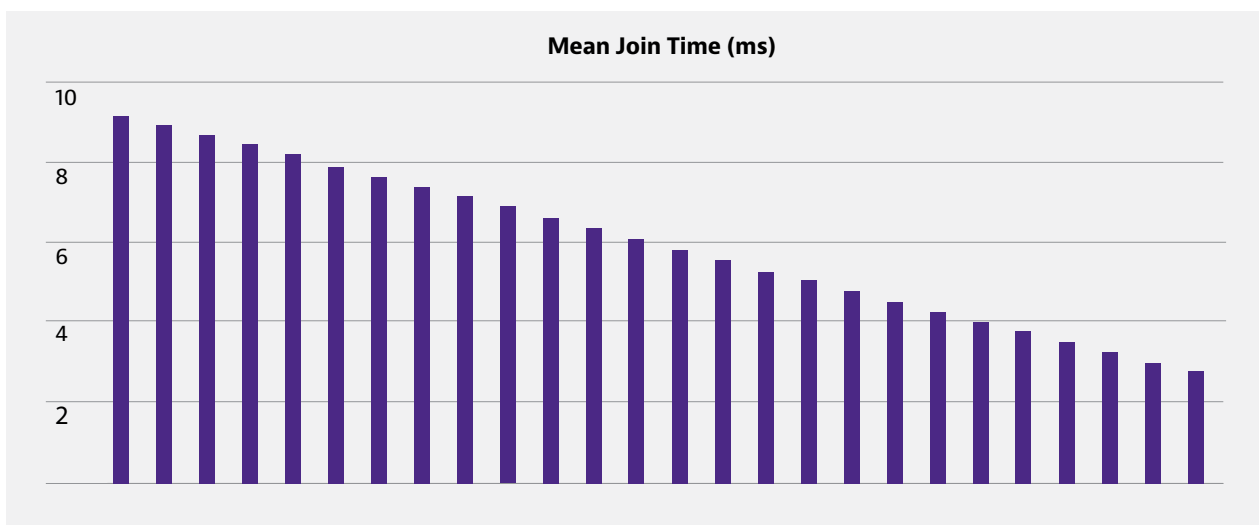

Figure 3: The mean join time associated with a multicast group



Figure 4: The average time to leave a multicast group



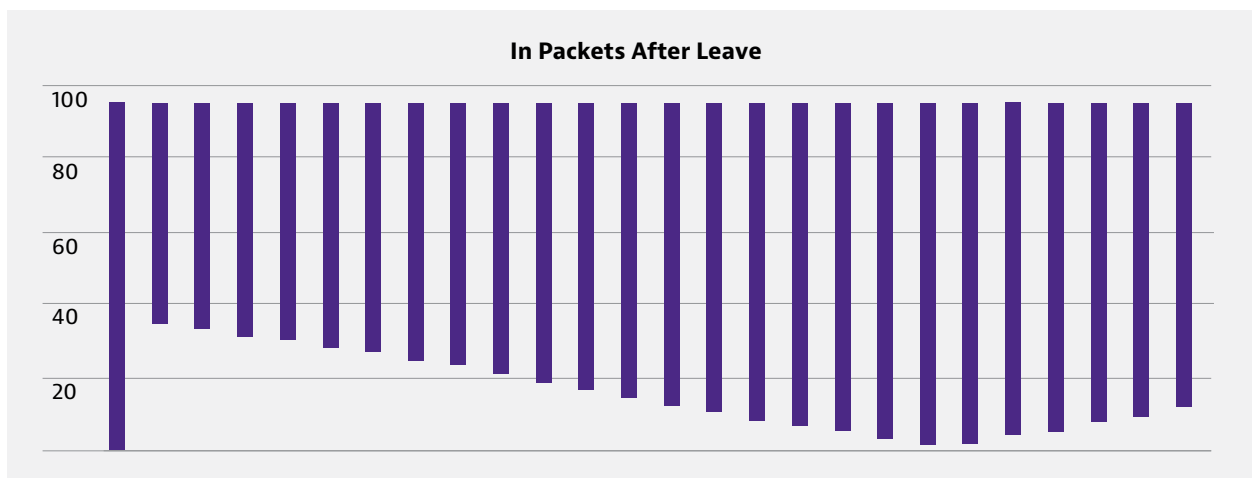

Figure 5: The average time to leave a multicast group

### Multicast join and leave performance analysis

TeraVM is used to determine the total number of multicast group changes that a multicast server/router can process. The multicast group hopping behavior is set in TeraVM by configuring several multicast group addresses for each emulated endpoint. Short duration and rejoin delays are used to maximize the group hop rate. Each multicast session is accessed concurrently by the endpoints. The performance objective is that each client can change groups three times a second. For a maximum of 2000 clients connected to the DSLAM, the requirement is for 6000 group changes/second. The test is run for at least 60 seconds, the results of this test are highlighted in Table 1 below. From the results, the number of joins issued is 139078 over 240 seconds, with an overall performance of ~580 group address request changes per second.

	Number of Clients	10
<b>Test summary</b>	time to join threshold (ms)	0
	test time	14:03:10: 201 seconds
<b>Application data</b>	time to join (ms)	min: 124,Ave: 216707: max: 295782
	number of joins	139078
	number of leaves	138978
<b>TCP details</b>	mean server bit rate (Mbps)	
	client to server:	
	packets dropped by clients:	0
	packets out of sequence:	0
	packet loss (%):	0

Table 1: 3rd party multicast server reliability testing performance results

### Case Scenario: Data Casting for Financial Services

Financial trading floors can span multiple floors and in some designs extend over multiple buildings in different locations. The most critical requirement for multicast trading networks is high availability with no downtime. This means that the network must be designed so that there is no single point of failure such that performance objectives are maintained during failover. In this high pressured environment, the goal is to create a test platform with reliable and repeatable tests which can be used to assess the resiliency of the multicast service. In this instance a test lab is configured to test solutions for financial enterprises such as stock brokers and banks.

## The Challenge

Financial enterprises have strict and exacting networking standards and the challenge of deploying any new service including multicast is that it is done rapidly and has no impact to existing services. For a new multicast service significant other challenges include security.

In addition to the deployment challenges, the multicast service has to be highly reliable and robust, demonstrating zero packet loss. Therefore, to ensure the highest availability of the multicast service requires performance analysis at scale i.e. for each user determine performance under normal and failover conditions.

## Mirroring the deployment topology

To enable successful and rapid deployment of new services, enterprises are utilizing virtualization technology. In the virtual sand box enterprises can quickly deploy mirrored network topologies with concise configurations to determine the impact new services have to existing services. Once a sample network topology is staged, the multicast service can be turned up allowing enterprises users of TeraVM to load:

- Traffic conditions similar to the mirrored network
- Emulate clients of the new multicast service

Multicast server deployments can be covered by two topology types, suitable for very large network deployments, these are:

- Hundreds of VLANs/thousands of clients communicating to one Multicast servers
- Hundreds of VLANs/thousands of clients communicating to many Multicast servers

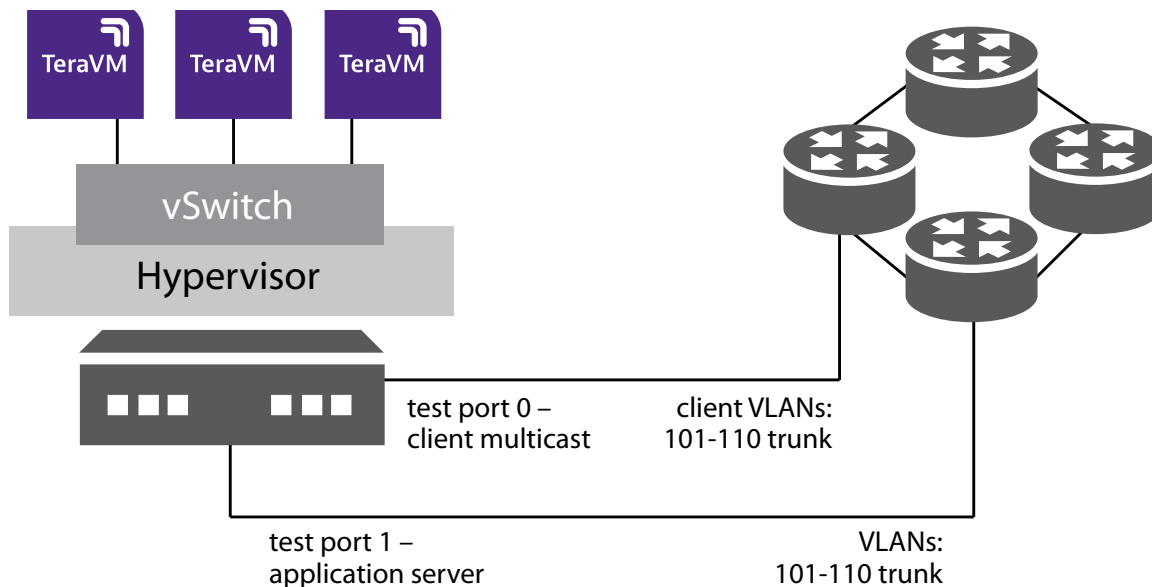

Figure 6: TeraVM testing Multicast Neighborhoods

## Multicast Test Configuration

Successful reliability and robustness testing of a multicast service deployment results in the need for a large number of active clients. On top of that and an evolving topology manual configuration of a continuously changing test environment is complex.

However, by using TeraVM enterprise users have a number of key features which simplify performance testing of large and evolving network designs:

- Automatic generation of test groups for complex many-to-many networks
- Ability to import the test groups via XML
- Facilitates the addition of new VLANs with “import and append”
- High VLAN density support – one test port supports over 500 VLANs
- Flexible results analysis to monitor different performance thresholds
- Multi-user client emulation configuration
- Per Application, Per User, Per VLAN performance analysis

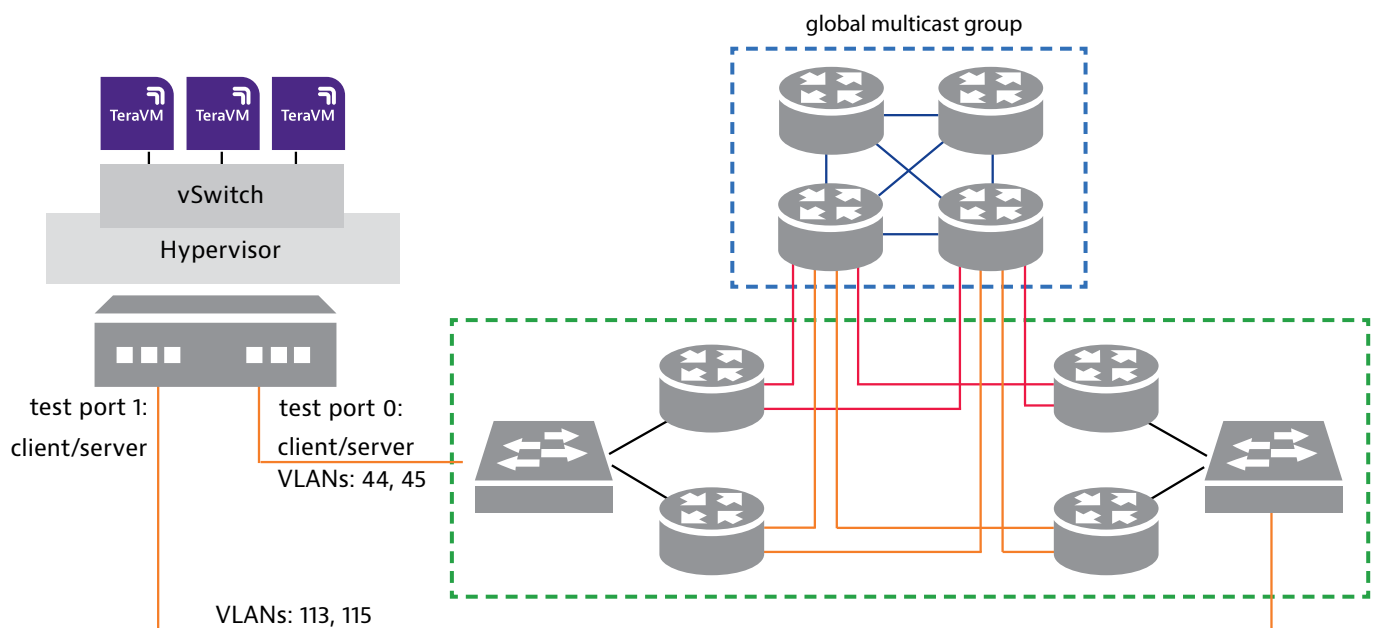

Figure 7: Evolved multicast topology, TeraVM easily scales to prove robustness

In TeraVM, users can quickly specify the VLAN configuration for a given test scenario. Furthermore via an automation harness, as the topology and test requirements change, the test configuration can be automated to adjust to the new test requirements.

Automation of the test means additional VLANs can be created and appended to the existing test group without the need for retooling, which would attribute as down time in a test plan that is not using TeraVM. Automated testing is extremely valuable to testers as it enables validation of new services in faster times, thus enabling enterprises rapidly deploy the new multicast service.

Once basic benchmarking of the multicast service has been completed, the next step is to test service resiliency by triggering failover. High availability services (in the presence of a failover) should show that all multicast traffic is delivered to each client with no packets dropped by the network.

With the multicast services deemed reliable, the next step is to emulate and analyze the performance of other applications which will run in parallel across the network.

A core feature of TeraVM is the ability to emulate basic TCP/UDP flows, along with actual application traffic such as multicast originating from unique MAC/IP addresses. This implies by testing with TeraVM the enterprise user can configure thousands of endpoints and associated applications with the minimum of effort, enabling complete dimensioning of the new multicast service with realistic traffic scenarios.

## Impact of IP multicast on existing application traffic

For all financial service enterprises, the ability to normalize from failover is key. Again repeating the failover test, enterprise can determine the recovery time for both multicast and unicast application traffic. TeraVM can be used to show application response times and packet loss for any one of its configured clients.

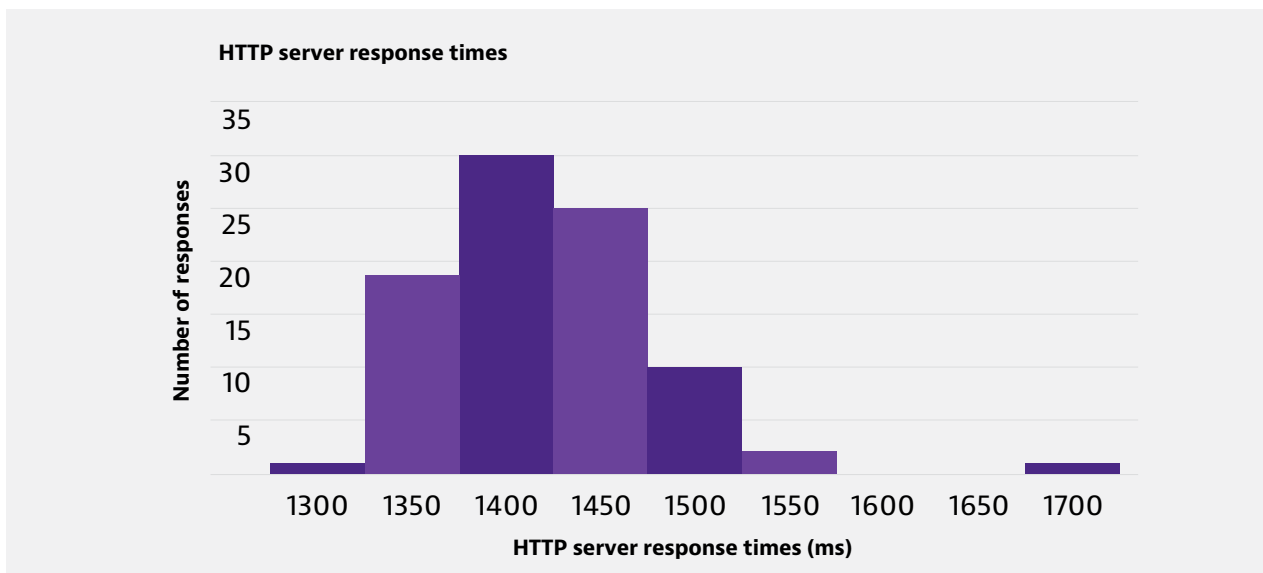

Figure 8: HTTP server response times in the presence of active multicast traffic on the network

TeraVM provides performance metrics on a per-client, per VLAN and per application basis. This provides the most granular view possible i.e. per user quality of experience for both multicast and unicast applications. The results show a small packet loss with application response times greater than 1 second, which is deemed insufficient for this type of enterprise network.

With TeraVM's analysis tool, results analysis is automatically run on a regular basis, where the results are correlated with the state of the network. Finally, with the wealth of information available, the analysis is configurable to display and graph a subset of results in many available forms (e.g. histogram, time series) enabling enterprises to quickly deploy new services in confidence.

## Conclusion

TeraVM is a fully virtualized test and measurement solution that can emulate and measure the performance of millions of multicast clients joining and leaving different multicast groups. TeraVM provides comprehensive measurement and performance analysis on each and every multicast flow with the ability to easily pinpoint and isolate problem group addresses.

The deployment of a multipoint service presents an interesting challenge for service providers and enterprises alike, in that they need to understand the performance capability of the underlying infrastructure and its ability

to handle multicast flows, which becomes even more critical in virtual environments where dedicated CPU is not always available.

TeraVM is used to emulate the endpoints or users connecting to the multicast service, which provides a controlled and repeatable approach to assessing the load capability of the multicast service and the reliability and performance of the network paths when delivering multicast services.

TeraVM enables concurrent testing of both IPv4 and IPv6 enabled multicast services, whilst the per flow performance analysis provides insight on each and every group in the multicast service. Emulation facilitates network robustness testing by enabling users test with a mix of subscriber traffic which includes multicast, voice and data. In addition, users of TeraVM can verify if the emulated flows are classified correctly with management systems, which includes analysis of errors in terms of handling and misclassification.

Enterprise and service providers deploying multicast use TeraVM as it not only offers the necessary multicast test capability, but offers greater flexibility and scalability to test both physical and virtual multicast enabled solutions.



To reach the VIAMI office nearest you,  
visit [viavisolutions.com/contact](http://viavisolutions.com/contact)

© 2018 VIAMI Solutions Inc.  
Product specifications and descriptions in this  
document are subject to change without notice.  
perftest-multicast-serv-wp-wir-nse-ae  
30187549 900 1118