

DWDM

Pocket Guide

Dense Wavelength Division Multiplexing



JDSU

JDSU is an active member of ITU-T



Publisher: JDSU
Postfach 12 62
72795 Eningen u.A.
Germany
e-mail: ines.brunn@jdsu.com
<http://www.jdsu.com>

Author: Ines Brunn

Content

Introduction	4
The history of DWDM	7
Components of a DWDM System	12
Transponder	13
Multiplexer (MUX)	14
Fiber	14
Amplifier	19
Demultiplexer (DEMUX)	29
Receiver	30
Summary	31
Limiting factors	32
Linear effects	33
Nonlinear effects	40
Further limitations	46
Conclusion	47
Measurements	52
Component conformance tests	52
Parameter tests on optical fibers	54
System installation tests	58
System optimization tests	63
System acceptance tests	65
Summary	68
Recommendations	71
Abbreviations	80

Introduction

With today's seemingly limitless demand for transmission capacity, service providers often cope with extreme fiber usage and exhaust across significant portions of their networks. An enormous amount of bandwidth capacity is therefore needed to provide the services required by customers. The expansion of existing links calls for simple, cost effective solutions that cause minimum disruption to working systems.

The telecommunications industry has so far met these needs by using dense wavelength division multiplexing (DWDM) systems. In allowing both new and existing fiber optic links to carry several channels simultaneously, DWDM can optimize the use of current facilities whilst offering greater capacities for the future.

Network operators are also faced with the challenge of having to integrate multiple technologies for the transmission of diverse services in a physical layer infrastructure.

Voice transmission, e-mail, video and multimedia data are just some examples of services which can be simultaneously transmitted in DWDM systems, regardless of their transmission formats which include synchronous optical network (SONET), synchronous digital hierarchy (SDH), asynchronous transfer mode (ATM), internet protocol (IP), packet over SONET/SDH (PoS) or gigabit ethernet (GigE).

Unlike previous systems however, the planning, installation, and maintenance of DWDM networks demands that much closer attention be paid to a number of performance limiting parameters.

figure 1 Time division multiplexing (TDM)

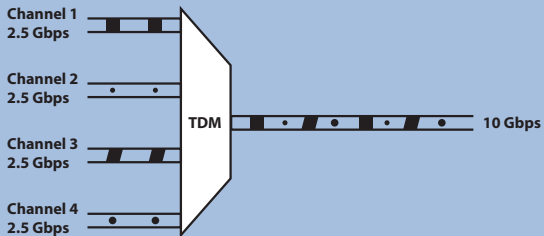

The history of DWDM The laying of new fiber was once the only way to cope with fiber exhaust in telecommunication networks. A cost and labor intensive process, the main drawback of this solution was its inability to enable network operators to provide new services.

At the beginning of the 1980s, time domain multiplexing (TDM) made it possible to increase the bit-rate. With TDM, the capacity of a single fiber could be increased by slicing time into smaller intervals and thereby multiplexing the different signals.

In TDM systems, each telecommunication fiber is able to transport an optical signal from a single laser (figure 1). This optical signal is converted into an electrical signal, regenerated (electrically reshaped, retimed and reamplified) and finally transformed back into an optical signal again encountering losses. High bit-rate transmissions via TDM however proved to be challenging.

Wavelength division multiplexing (WDM), the simultaneous transmission of multiple signals at different wavelengths over a single fiber proved to be a more reliable alternative (figure 2).

figure 2 Dense wavelength division multiplexing (DWDM)

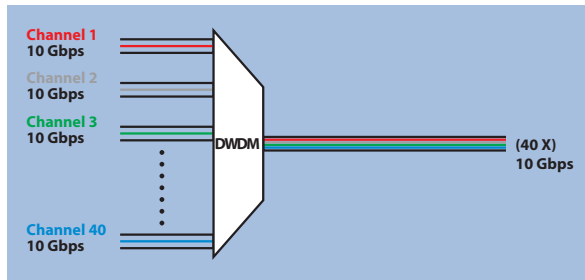

The first networks deploying WDM technology at the end of the 1980s, multiplexed signals from the lasers of two very different wavelengths (a technology now referred to as Coarse WDM). The disadvantage of this technique was that the multiplexed signal had to be separated each time before being electrically regenerated.

Today's modern CWDM system (such as those with over 20 nanometers (nm) channel spacing), are used for short range transmissions where no regeneration is required. They transmit up to 16 channels between 1310 and 1610 nm, thus making CWDM a cost effective solution.

During the 1990s, networks were designed to send up to four different signals over one fiber at different wavelengths within the same optical window (Broadband WDM). This is an application however necessitating the use of narrow lasers.

In order to increase the number of services (bandwidth), the channel spaces can be moved closer together (for example with a space of just 0.8 nm between two channels), creating Dense WDM or DWDM as it is commonly known. This technology economically increases transport capacity through the utilization of existing fiber routes and terminal equipment.

Unidirectional systems with the following capacities have already been successfully tested in research laboratories:

- 320 x 2.5 Gbps (total: 800 Gbps)
- 160 x 10 Gbps (total: 1.6 Tbps)
- 128 x 40 Gbps (total: 5.12 Tbps)

While debate continues as to whether WDM or TDM is best suited for the expansion of existing fiber networks, it has become clear that only solutions incorporating both technologies will give service providers the flexibility and capacity for future requirements (figure 3). These requirements could for example enable them to:

- Maintain different dedicated wavelengths for different customers
- Lease individual wavelengths as opposed to entire fibers
- Expand portions of their networks (for example, where multiple rings intersect between two nodes)

figure 3 Increased capacity by combining TDM with DWDM

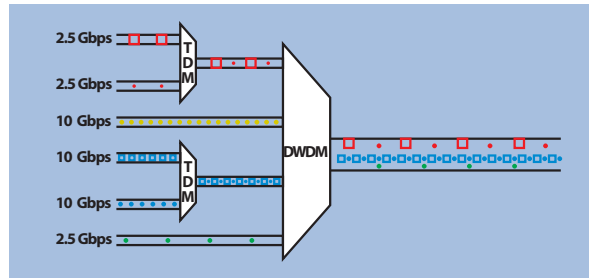

Demands for new data services, home office and internet applications all contribute to the pressure being placed on service providers worldwide. Although 10 Gbps seems to be a sufficiently high bit-rate for most networks today, this level of capacity may not be enough in the long term.

figure 4 Capacity of TDM and TDM & DWDM systems

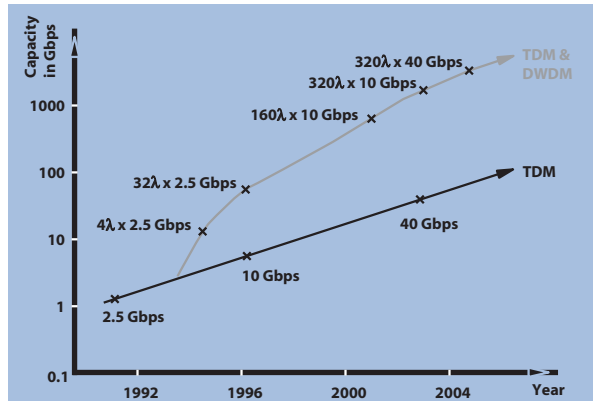

Components of a DWDM system

A DWDM system can be described as a parallel set of optical channels, each using a slightly different wavelength, but all sharing a single transmission medium or fiber.

Figure 5 illustrates the functionality of a multichannel DWDM transmission system when various 10 Gbps signals are fed to optical transmission modules. An optical DWDM coupler (multiplexer) then 'bunches' these optical signals together on one fiber and forwards them as a multiplexed signal to an optical fiber amplifier (OFA).

figure 5 Multichannel DWDM transmission system

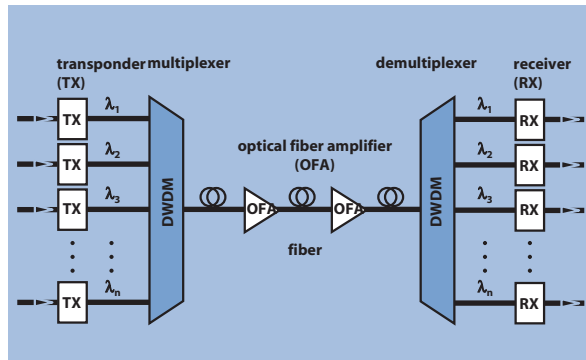

Depending on path length and type of fiber used, one or more OFAs can be used to boost the optical signal for long fiber links.

At termination on the receiving end, the optical signals are preamplified, then separated using optical filters (demultiplexer) before being converted into electrical signals in the receiver modules.

For bidirectional transmission, this procedure must be duplicated in the opposite direction to carry the signals in that particular direction.

Transponder

Transponders receive optical signals and send them out carrying digital information at predefined wavelengths in accordance with the ITU-T guidelines (see reference table on pages 75 to 79).

A single channel transmitter typically consists of a high power distributed feedback (DFB) laser followed by a modulator. Direct modulation of the laser is common up to 2.5 Gbps. For higher transmission rates as a result of laser chirp, an external modulator must be used.

DFB lasers offer greater precision than Fabry-Perot (FP) lasers, the latter of which emits harmonics close to the main peak rendering them unsuitable for DWDM systems. In DWDM systems both fixed and tuneable laser sources can be utilized.

In networks with dense channel spacing, transponder temperature must be stabilized. This can be enabled with the use of thermo-electric coolers.

Multiplexer (MUX)

MUX are deployed in DWDM systems to combine the signals at different wavelengths onto a single fiber through which they then travel simultaneously. Each wavelength carries its own information and represents a channel.

An ideal MUX requires uniformly high transmission across the passband with a very high drop at the edge.

Fiber

The fiber is one of the most critical components of a DWDM system as it provides the physical transportation medium.

Optical fibers consist of both core and cladding. The core is the inner, light-guiding section and is surrounded by the cladding. As the refractive index of the core is higher than that of the cladding, light entering it at an angle – or numerical aperture – is fully reflected (almost 100 percent) off the core/cladding boundary and propagates down the length of the fiber.

Optical fibers can be divided into multimode and singlemode fibers, each approximately the size of a human hair, with an outer diameter of 125 μm . Core size however differs. The diameter of multimode fibers range from between 50 μm and 62.5 μm , whilst for singlemode fibers it is between 7 and 10 μm .

Light propagates down the fiber core in a stable path known as a mode. In multimode fibers, multiple paths arise making them unsuitable for use in long haul DWDM transmission.

The core of singlemode fibers is so narrow that it can only support one mode, making it the only suitable choice for use in DWDM telecommunication networks.

The optical attenuation in a fiber does not remain constant over the wavelength of a transmitted signal. There are three regions of locally low attenuation which are suitable for the transportation of telecommunication signals. They are known as the first (around 850 nm), second (around 1310 nm) and third (around 1550 nm) optical windows (figure 6).

figure 6 *Optical attenuation in a singlemode fiber*

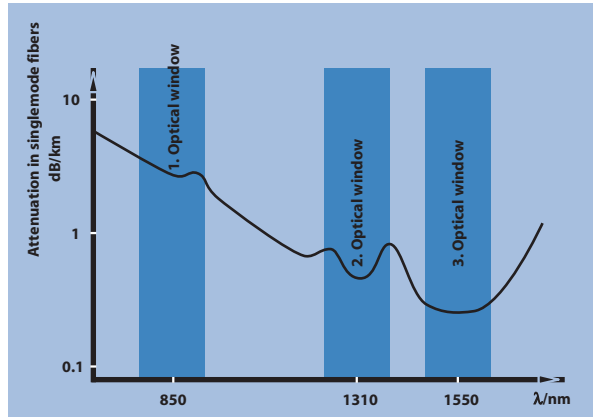

The first singlemode fibers used for long haul communication had zero dispersion at 1310 nm. These are often referred to as G.652 fibers, or standard fibers in the ITU-T format (see table 5). Though standard optical fibers show slightly more attenuation in the 1310 nm window than in the 1550 nm window, they have less chromatic dispersion (CD). It is also easier to build higher power lasers in the 1310 nm region. More than 80 million kilometers of this fiber type was installed during the 1980s.

In order to transmit in the region of lowest attenuation (around 1550 nm) with zero CD, fiber manufacturers developed dispersion shifted fiber (DSF). These fibers were targeted to become standard for new installations and were deployed mainly in Japan. Today, these fibers are exhibiting problems with nonlinear effects due to the use of multiple channels and high transmission rates.

In DWDM systems, some nonlinear effects arising from the transmission of many wavelengths and the usage of high-power lasers, can be reduced by leaving a small amount of CD in the fiber. These fibers are known as non-zero dispersion shifted fiber (NZDSF). See Chromatic dispersion (page 34 onwards) for the various fiber types.

In DWDM systems the fibers can be used either unidirectionally (signals transmitted in one direction only per fiber) or bidirectionally (signals traveling in both directions).

Amplifier

Amplifiers boost signals traveling down a fiber so they can cover longer spans. In the early stages of fiber optic telecommunications, lasers emitted relatively low power which led to the signal having to be frequently electrically regenerated (figure 7). These amplifiers receive the optical signal and convert it into an electrical signal (O/E conversion) which is then reshaped, retimed and amplified again. This is the so called 3R regenerator. Finally, the signal is converted back to an optical signal (E/O conversion).

In DWDM systems, the multiplexed signal has to be demultiplexed before each channel is regenerated, emitted by a laser and then multiplexed again. This is a process which is both complex and expensive.

figure 7 Principle of an electrical regenerator

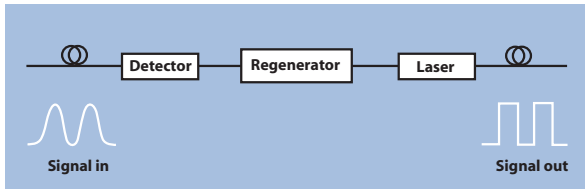

Optical fiber amplifiers (OFAs) can be used to provide a more economical solution. These can work solely in the optical domain, performing a 1R (optical reamplification only) regeneration. OFAs simultaneously amplify each wavelength of the DWDM signal without the need for demultiplexing and remultiplexing. One major advantage of OFAs is their transparency to signal speed and data type.

Three types of OFAs are deployed in DWDM systems: erbium doped fiber amplifier (EDFA), semiconductor optical amplifiers (SOA) and Raman fiber amplifiers (RFA).

Currently, the most common OFA in use is the EDFA (figure 8). This is a piece of optical fiber doped with erbium ions (Er^{3+}). Radiation from a powerful pump laser outside the data wavelength range is coupled into this fiber resulting in an amplification of the data signal.

figure 8 Principle of an erbium doped fiber amplifier (EDFA)

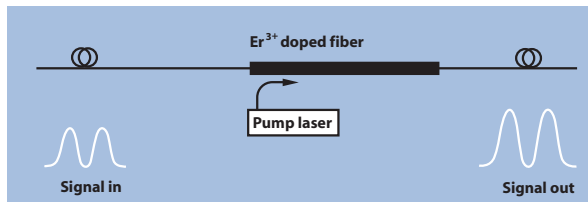

SOAs are based on the semiconductor laser technology principle and use semiconductor material as the active medium.

RFAs use the Raman effect – or stimulated Raman scattering (SRS) – as described under limiting factors (page 32 onwards) to transfer power from the pump laser at a shorter wavelength to the optical signal. It uses either the transmission fiber as the active medium (distributed Raman amplification), or a part of the fiber inside a structure (discrete Raman amplification). The optical fiber is commonly counter pumped (pumped backwards) with a 600 mW laser which is most efficient with a wavelength difference of 100 nm (13.2 THz) to the signal (figure 9).

figure 9 Principle of a Raman fiber amplifier (RFA) and its effect on signal intensity

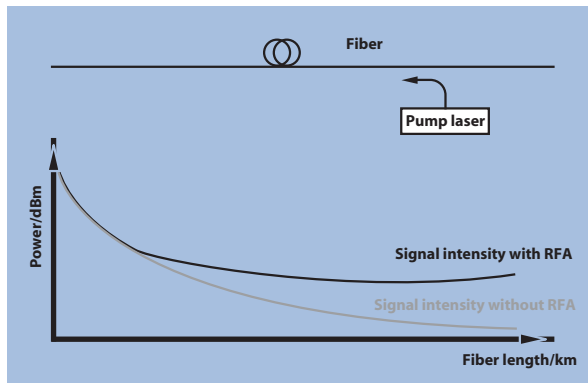
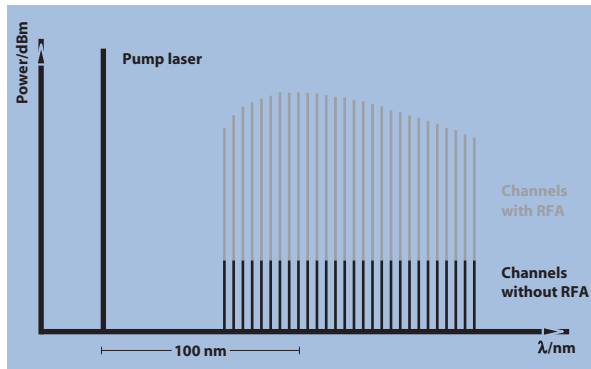

figure 10 Amplification with one RFA
pump laser



Besides amplifying the data signals, spontaneous emission of photons also occurs in fiber amplifiers. These photons in turn are also amplified adding to the noise. The resulting spurious signal known as amplified spontaneous emission (ASE) has a large magnitude with the power of several mW (figure 11). This effect becomes critical with the intense use of EDFAs (cascaded EDFAs).

figure 11 Amplified spontaneous emission (ASE)

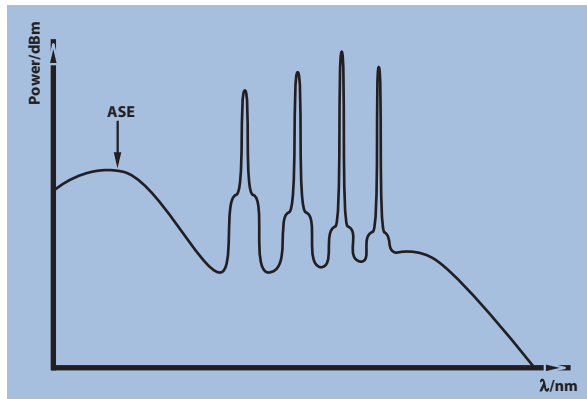

table 1 Overview of OFAs

The optical supervisory channels (OSC) present additional challenges given that DWDM operators usually assign them to wavelengths outside the operating bandwidth of EDFAs. This complicates the process as these extra channels have to be separated from the signal, converted, separately regenerated and then reinserted to the multiplexed signal at every EDFA.

Characteristics	EDFA	SOA	RFA
Gain bandwidth	40 nm	Approx. 50 nm	Approx. 150 nm
Wavelength region	One for C- another for L-band	Over entire region	Over entire region for excitation lasers, with 100 nm (13.2 THz) difference to the signal
Typical gain	20 to 30 dB	22 to 30 dB	10 to 15 dB
Typical output power	21 dBm	13 dBm	Used as broadband preamplifiers
Noise figure	4 to 5 dB	8 to 10 dB	-1 to 4 dB

Characteristics	EDFA	SOA	RFA
Gain slope	For C-band. None for L-band	Slight slope	Dependent on distribution of (several) lasers

EDFAs can be used in three different working regimes:

- As preamplifiers in front of a receiver with the lowest noise possible to boost the low signal at the end of the line
- As in-line repeaters with intermediate gain and noise performance to fully amplify the signal to the highest level but without amplifying the noise significantly from one repeater to the next
- As boosters (power amplifiers or post-amplifiers) immediately behind the transmitter laser to push the location of the repeater as far as possible down the line

Current SOAs have the disadvantage of having high noise figures which cause distortion of the signal if more than one channel is transmitted. A future application for these amplifiers could be in optical cross connects (OXC).

RFAs are mostly used as preamplifiers (pumped backwards) for bringing up the signal and therefore covering longer spans.

The new, future-proof systems are designed with a combination of EDFAs and distributed RFAs to minimize the disadvantages and utilize the advantages of both devices (table 1). This is a topology crucial for 40 Gbps transmission. Newer technology developments tend to be driven mainly by cost reducing factors.

Demultiplexer (DEMUX)

DEMUXs unscramble multiplexed channels before they are fed into their corresponding receivers. They work similarly to MUXs but operate in the reverse direction.

It is common to preamplify optical signals before they are separated by the optical filters of the demultiplexer. The performance of a MUX or DEMUX is related to its capability to filter each incoming signal. The Bragg grating is currently the most popular technique used in DWDM systems.

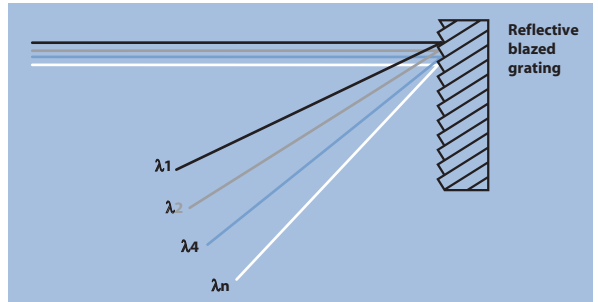

figure 12 Principle of a demultiplexer

Receiver

Receivers are used to convert optical signals into electrical signals.

The light pulses transmitted over the optical fiber are received by a light sensitive device known as a photo diode which is made of semi-conductor material.

Either avalanche photo diodes (APD) or PIN diodes can be used (table 2).

table 2 Receiver sensitivity at various bit-rates

Bit-rate	Sensitivity	Diode type
2.5 Gbps	-25 dBm	PIN
2.5 Gbps	-34 dBm	APD
10 Gbps	-19 dBm	PIN
10 Gbps	-27 dBm	ADP

Summary

To obtain the expected performance from the entire DWDM network, a careful spectral selection of optical sources, multiplexers, fibers, optical amplifiers, demultiplexers and receivers has to be made.

The performance characteristics and limitations of a DWDM network system are dependent on the following factors:

- The ***fiber characteristics*** – see next chapter
- The laser transmission ***output power*** – the higher the output, the greater the increase in the transmission span length (unless limited by fiber non-linear effects)
- The laser ***modulation frequencies*** – long haul communications use OC-48/STM-16 (2.5 Gbps) or OC-192/STM-64 (10 Gbps)
- The ***number of channels*** – the number of channels multiplied by the modulation determines the total bandwidth of the system
- The ***channel spacing*** capability – for example the 100 GHz ITU-T grid
- The ***amplifier gain*** – both spectral width (typically 40 to 50 nm) and amplitude (typically 20 to 30 dB)
- The ***receiver sensitivity***

Limiting factors

In SONET/SDH systems, the limiting parameters are digital whereas in DWDM systems, with high power and high number of channels, it is usually the analog impairments which limit the transmission. These impairments on singlemode fibers can be divided into linear and nonlinear effects (figure 13).

figure 13 Overview of impairments in singlemode fibers

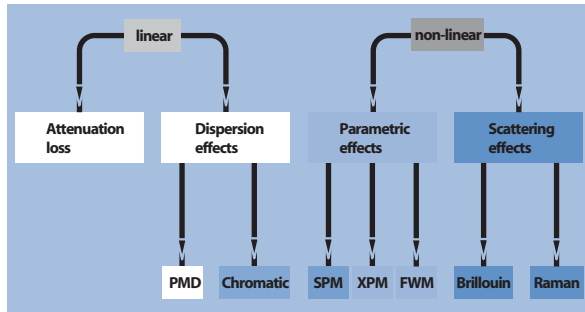

Linear effects

Attenuation and noise – Attenuation is the loss of signal power due to, for example, material absorption and impurities (figure 14). Attenuation depends on the fiber length and is the main reason for the regeneration of signals after certain distances.

Noise is unwanted power which can be caused by factors such as system components or by natural disturbances. In DWDM systems the noise is mainly generated by the optical to electrical (O/E) converters and optical fiber amplifiers producing amplified spontaneous emission (ASE) noise.

figure 14 Attenuation and noise

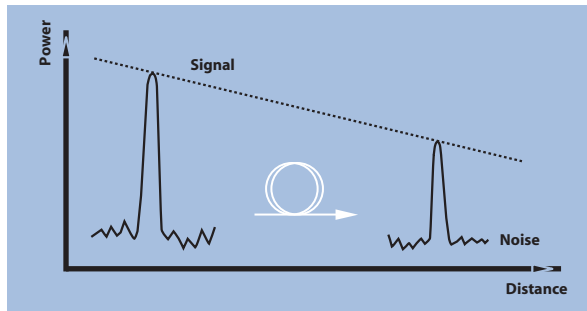
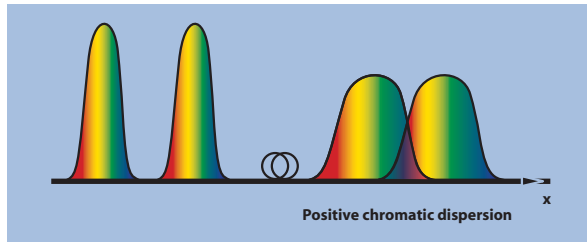

figure 15 Chromatic dispersion

Chromatic dispersion (CD) – CD is the phenomenon of different wavelengths inside an optical signal (typical pulse width in DWDM systems: 0.2 nm) traveling at different velocities along a fiber and arriving at different times in the receiver (figure 15).



The slope of the delay curve at a given wavelength is called the CD coefficient.

This coefficient can be positive or negative, depending on the wavelength and the material used. A positive dispersion coefficient – a typical value in standard single-mode fibers would be: 17 ps/(nm*km) – would signify longer wavelengths falling behind shorter wavelengths.

Dispersion compensation modules (DCM) remove the effects of chromatic dispersion accumulated during transmission, by using an element which creates a reverse behavior of the velocity per wavelength. There are two main methods of compensating chromatic dispersion:

- Utilizing a dispersion compensation fiber (DCF)
- Using fiber Bragg grating

DCF is a fiber with a negative dispersion value for the transmission wavelengths. This means that the effect of positive chromatic dispersion can be cancelled out. DCMs are often integrated into OFAs, with some types adjustable to react on temperature dependent changes of the CD value.

The point of zero chromatic dispersion is located at around 1310 nm for standard singlemode fibers (standardized in ITU-T G.652).

A dispersion shifted fiber (DSF) – as standardized in ITU-T G.653 – has its point of zero dispersion shifted toward the 1550 nm wavelength window. DSF fibers have zero dispersion values throughout their effective area. A small amount of CD is necessary however to minimize nonlinear effects such as four wave mixing (FWM) and cross phase modulation (XPM). This particular type of fiber type is not suitable for high bit-rate DWDM transmissions.

Non-zero dispersion shifted fibers (NZDSF) – as described in ITU-T G.655 – are fibers containing a small level of positive chromatic dispersion at 1550 nm. This level has to be high enough to prevent the DWDM transmission suffering from nonlinearities, but low enough to reduce the intense use of dispersion compensation modules.

Polarization mode dispersion (PMD) – is the effect of the different polarization modes (horizontal and vertical) of a signal statistically traveling at different velocities due to fiber imperfections which arise from:

- The transport medium not being perfectly cylindrical along its overall length
- Dopants in the cladding – causing an extremely high refractive index – being statistically distributed and potentially resulting in clusters
- The fiber being twisted, tapered, or bent at some points along the span

The result is an effect referred to as pulse broadening.

A singlemode fiber can be resolved in two modes of orthogonal polarization. The imperfections mentioned above result in a statistically changing refractive index for both polarization modes individually. Therefore, the two different polarization components of the signal travel statistically at different speeds – having different group velocities – through the fiber. The mean value of this statistical group delay (represented in figure 16 as $\Delta\tau$) is called polarization mode dispersion (PMD) delay.

figure 16 Polarization mode dispersion

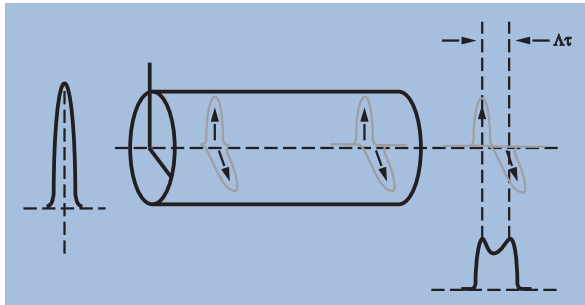

The PMD coefficient (given in ps/ $\sqrt{\text{km}}$) varies throughout different parts of the fiber and is subject to mechanical stress and temperature. If the PMD limits for a certain fiber are exceeded for high bit-rates, a lower transmission rate has to be used. Recently developed singlemode fibers have exhibited very low PMD values (that is, less than 0.1 ps/ $\sqrt{\text{km}}$).

PMD itself is a major limitation on high bit-rate (ie 10 Gbps and above) transmissions. Table 3 below provides an overview of recommended values for various transmission rates (assumes 200 km length):

table 3 Recommended values for various transmission rates

Transmission bit rate	Maximum acceptable PMD value
2.5 Gbps	40 ps
10 Gbps	10 ps
40 Gbps	2.5 ps

Nonlinear effects

With both high power and an increasing number of optical channels, nonlinear effects can become problematic factors in DWDM systems. These analog effects can be divided in two categories – the refractive index phenomena, which cause phase modulation, and the scattering phenomena which lead to power loss.

Refractive index phenomena – These nonlinear effects are dependent upon the nonlinear part of the refractive index “ n ” causing the refractive index to increase for high signal power. Behind an EDFA, the substantial output can create effects such as four wave mixing (FWM), self phase modulation (SPM) and cross phase modulation (XPM), all of which are described in the following sections.

Four wave mixing (FWM) is an interference phenomenon that produces unwanted signals from three signal frequencies ($f_{xyz} = f_x + f_y - f_z$) known as ghost channels (figure 17). Because three different channels induce a fourth, this phenomenon is referred to as four wave mixing.

There are a number of ways in which channels can combine to form a new channel according to the formula above. It should also be noted that just two channels alone are capable of inducing a third.

figure 17 Four wave mixing

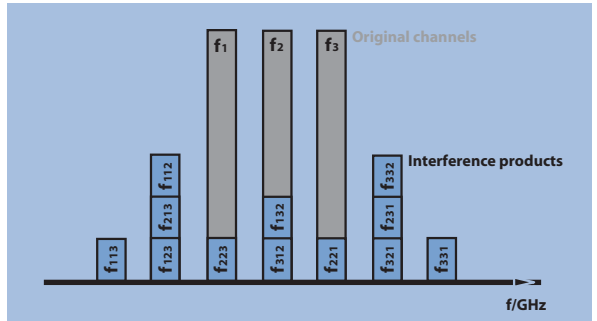

With high power levels, the FWM effect produces a number of ghost channels (some of which overlap actual signal channels) depending on the number of actual signal channels. For example, a four channel system would produce 24 ghost channels and a 16 channel system would produce 1920 unwanted channels. FWM is therefore one of the most adverse nonlinear effects in DWDM systems.

In systems using DSF fiber, FWM becomes a tremendous problem. Different wavelengths traveling at the same speed – or group velocity – at a constant phase over a long period of time, increase the effect of FWM. In standard fibers however, a certain amount of CD leads to different wavelengths having different group velocities. This results in a reduction of FWM which can also be achieved with irregular channel spacing.

Self phase modulation (SPM) is the effect a signal has on its own phase, resulting in signal spreading.

With high signal intensities, the light itself induces local variable changes in the refractive index of the fiber known as the Kerr effect. This produces a time varying phase in the same channel. The result is a shift towards shorter wavelengths at the trailing edge of the signal as well as a shift to longer wavelengths at the leading edge of the signal pulse (figure 18).

figure 18 Self phase modulation

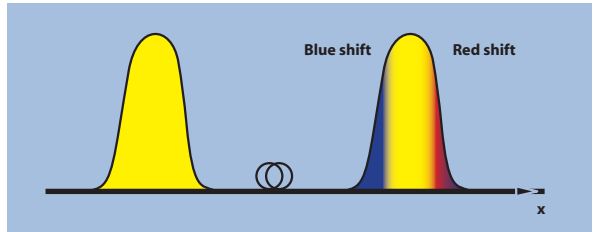

The wavelength shifts caused by SPM are the exact opposite of positive chromatic dispersion. In advanced network designs, SPM can be used for partly compensating the CD effects.

Cross phase modulation (XPM) is the effect a signal in one channel has on the phase of another signal.

XPM occurs also as a result of the Kerr effect (like SPM) but only arises when multiple channels are transmitted on the same fiber. The same frequency shifts at the edges of the signal in the modulated channel occur as in SPM which spectrally broadens the signal pulse.

Scattering processes – Scattering phenomena can be categorized according to the processes when the laser signal is scattered by fiber molecular vibrations (optical phonons) or by an induced virtual grating.

Stimulated Raman scattering (SRS) is an effect which transfers power from a signal at a shorter wavelength to a signal at a longer wavelength (figure 19).

The process is caused by the interaction of signal light waves with vibrating molecules (optical phonons) within the silica fiber. Light is then scattered in all directions. This effect has its maximum for a wavelength difference between the two signals of about 100 nm (13.2 THz).

figure 19 Stimulated Raman scattering (SRS)

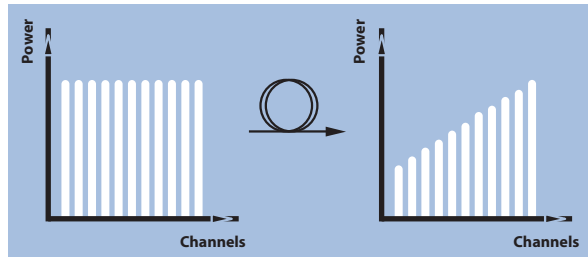

Stimulated Brillouin scattering (SBS) is a backscattering process causing loss of power.

With high power, the signal lightwaves induce periodic changes in the refractive index of the fiber. This can be described as a virtual grating traveling away from the signal as an acoustic wave. The signal itself is then scattered, but mostly reflected off this induced grating.

Further limitations

DWDM systems are limited by fiber characteristics and the boundaries derived from other components.

Crosstalk occurs in devices that filter and separate wavelengths. A small proportion of the optical power which should have been sent to a particular channel, (particular filter output), can actually be found in either an adjacent or different channel. Crosstalk is critical in DWDM systems, since it generates additional noise which can affect the optical signal-to-noise ratio (OSNR) and thus create bit-errors.

The insertion loss of the signal entering into a network system device, and the back reflection of a part of the signal at a border both reduce the quality of the signal.

Conclusion

table 4 Overview of limiting physical effects in DWDM systems

In designing DWDM systems, limiting physical effects (particularly nonlinear) need to be taken into account (table 4).

Impairment	Cause	Critical power per channel	Effect	Compensation
Attenuation/ Noise	Material absorption/ System		– Decrease of peak power – Bit-errors components	Shorter spans, purer fiber material, amplification
CD	Wavelength dependent group velocity		– Decrease of peak power – Pulse (spectral) broadening – Bit-errors	Use of fibers or modules with reverse CD values (DCF/DCM)
PMD	Fiber imperfections due to statistically changing refractive index		– Decrease of peak power – Distortion of pulse shape – Bit-errors	New fiber with low PMD values, exact fiber geometry, careful fiber laying (no stress)

table 4 (continued)

Impairment	Cause	Critical power per channel	Effect	Compensation
FWM	Interference of signals	10 dBm	<ul style="list-style-type: none"> – Power transfer from original signal to new signal frequencies – Production of sidebands (harmonics) – Channel crosstalk – Bit-errors 	Use of fibers with CD, irregular channel spacing
SPM XPM	Intensity dependent refractive index (Kerr effect)	10 dBm	<ul style="list-style-type: none"> – Spectral broadening – Initial pulse compression (in positive CD regime) – Accelerated pulse broadening (in negative CD regime) 	Use of fibers broadening with CD

table 4 (continued)

Impairment	Cause	Critical power per channel	Effect	Compensation
			– Bit-errors	
SRS	Interaction of photons with optical phonons	1 dBm	– Decrease of peak power – Decrease of OSNR – Optical crosstalk especially in bidirectional DWDM systems – Bit-errors	Careful power level design
SBS	Interaction of photons with acoustic phonons	5 dBm	– Decrease of peak power – Decrease of OSNR – Signal instability	Spectral broadening of the light source

table 4 (continued)

Impairment	Cause	Critical power per channel	Effect	Compensation
			<ul style="list-style-type: none"> – Optical crosstalk especially in bidirectional DWDM systems – Bit-errors 	

Table 5 provides an overview of the impairments affected by adjustable network system parameters.

table 5 Parameters affecting impairment
(denoted with "X")

Parameter	Noise	CD	PMD	FWM	SPM	XPM	SRS	SBS
Channel spacing				X		X		
Number of channels	X		X	X		X	X	X
Channel power				X	X	X	X	X
Number of spans	X		X	X	X	X	X	X
Channel bit-rate	X	X	X		X	X		X
Fiber effective area				X	X	X	X	X

NB: Empty spaces in the table above do not necessarily mean the impairment is not effected by the parameter. There are however parameters which are not represented in this table. For example mechanical stress effects PMD whilst temperature has an impact on both PMD and CD. In 40 Gbps transmissions the dispersion compensating modules have to be adjustable to correct the CD value which itself varies with temperature.

Measurements

The optical and digital characteristics of all the different components must be measured before use in DWDM systems. Components tested to meet the specifications separately, could interact unpredictably when installed in a system. A variety of tests must therefore be performed during different phases of network implementation.

Component conformance tests

The critical optical parameters to be measured in each network component are listed below:

Transponder

- Center wavelength and spectral width of emitted channel
- Spectral stability over time and temperature
- Output power (maximum: 17 dBm in accordance with laser protection regulations) and output power stability
- Sidemode suppression ratio (should be 40 dB)

Multiplexer and demultiplexer

- Wavelengths of passbands of the different channels
- Channel crosstalk (pulse wavelength overlap)
- Channel insertion loss
- Optical return loss (back-reflection ratio)
- Polarization mode dispersion (PMD)
- Polarization dispersion loss (PDL)

Amplifier

- Channel center wavelength and channel spacing
- Spectral stability over time and temperature
- Gain and wavelength dependence of the gain
- Noise figure
- Output power and output power stability

Dispersion compensating modules

- Insertion loss
- Group velocity over wavelength
- Chromatic dispersion (CD)

Receiver

- Back-reflection
- Optical and electrical bandwidth
- Sensitivity

Parameter tests on optical fibers

There are additional digital parameter tests which must be performed before the network elements are brought together into a network system. These include:

- Maximum tolerable jitter and jitter transfer function (JTF)
- Long term zero bit-error rate (BER) stability

Before fiber is laid, the CD value has to be measured especially for transmission rates of 10 Gbps and above. The dispersion compensating modules can then be designed for a controlled value of CD.

The CD delay can be derived from optical time domain reflectometer (OTDR) measurements at four wavelengths – 1310 nm, 1420 nm, 1550 nm and 1620 nm.

Corresponding group delays can then be calculated based on the propagation time of the reflection of each wavelength. With these four group delay values it is possible to approximate the CD delay versus wavelength from which the CD coefficient can be calculated (figure 20).

Once the fiber is laid, the polarization mode dispersion (PMD) value must be measured given that it is strongly affected by mechanical stress.

figure 20 Chromatic dispersion coefficients for various fiber types

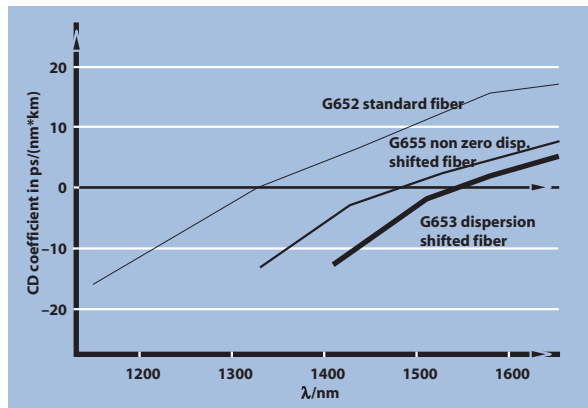

This can be done via the fixed analyzer method – wavelength scanning – (figure 21). This method requires a polarized broadband light source, polarizer and an optical spectrum analyzer (OSA). From the spectrum, the rate at which the state of polarization changes over wavelength is measured to give a mean differential group delay (DGD).

PMD measurements should be performed when the bit-rate is equal to or higher than 10 Gbps. However with analog cable TV applications for example, lower transmission bit-rates will already have been affected by PMD.

figure 21 PMD measurement principle

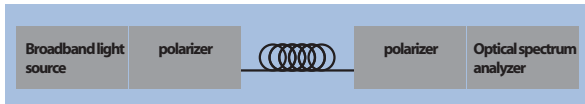

The optical time domain reflectometer (OTDR) has become the standard instrument for the testing of optical networks. They can also be used to locate defects and mechanical stresses on the fiber itself such as micro and macro bending (figure 22). OTDR measurements at two wavelengths (1550 nm and 1625 nm) are necessary to perform these location measurement procedures.

figure 22 OTDR result illustrating splice peaks

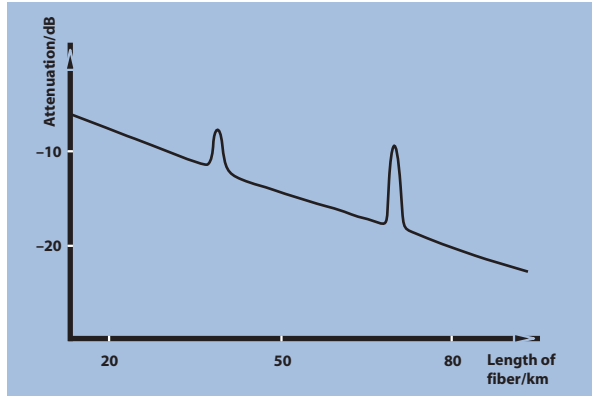

When systems are upgraded to higher bit-rates, the fiber currently in use must be retested to assess its ability to meet the recommendations for the higher bit-rates. If a fiber used for 2.5 Gbps transmission is not suitable for system upgrade to 10 Gbps, implementation of a 10.7 Gbps system with forward error correction (FEC) could be a more cost effective alternative to laying new fiber.

Once the fiber has been laid and tested, a number of measurements and procedures must be carried out during component installation, system optimization and then acceptance testing, in which diverse measurements are crucial for an efficient network.

System installation tests

During system installation, it is important to measure the optical parameters of the system. In a DWDM network, an optical spectrum analyzer (OSA) is used to measure efficiently the power, wavelength and OSNR of each transmitted channel to ensure transmission quality.

Although commonly used in network development and test laboratories, newer OSAs can also be used for field measurements. They have the same specifications as those deployed in labs but are portable, shock proof and can accommodate high-quality online calibration. Often referred to as DWDM analyzers, OSAs deliver powerful software features for easy qualification of DWDM networks.

Their measurement capabilities should include:

- Channel power in dBm
- Power stability
- Channel center wavelength (0.1 nm resolution) and spacing

- Wavelength stability
- Optical signal-to-noise ratio (OSNR) for each channel and OSNR stability
- Total optical power

These capabilities are illustrated in figure 23.

figure 23 Signal characteristics

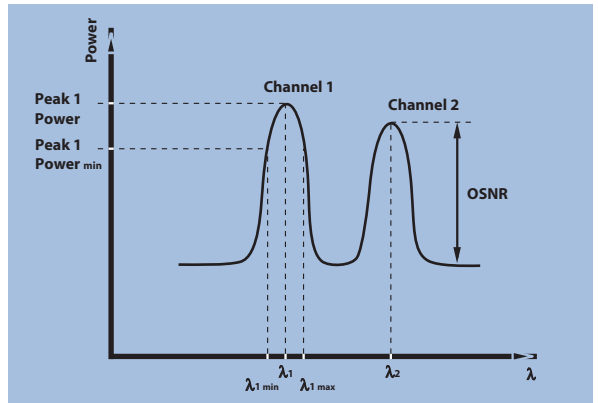

Optical measurements should be performed at reference test points (according to the ITU-T recommendation G.692) that are to be provided in DWDM systems (see figure 24):

- MPI-S and MPI-R are main points of interest where most measurements can be performed as checks
- S1 to Sn are reference points directly at the output of the individual optical transmitters 1 to n of the DWDM system. RM1 to RMn are test points for the individual fibers directly at the input of the DWDM multiplexer
- S' is the test point directly at the output of the DWDM multiplexer, R' the test point directly at the input of the demultiplexer
- SD1 to SDn are reference points directly at the output of the demultiplexer. R1 to Rn are at the input of the individual receiver modules

figure 24 Testing with an OSA at reference test points in DWDM systems

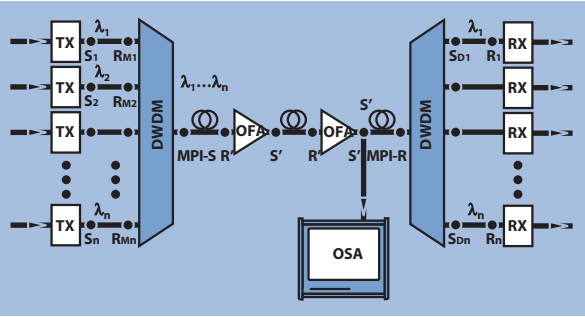
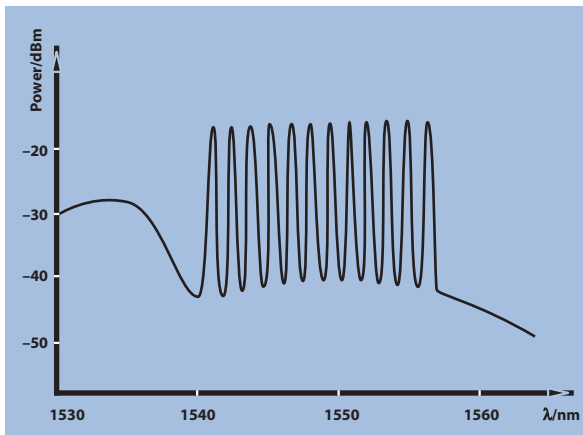

figure 25 Typical OSA scan of a 16 channel DWDM system



System optimization tests

After the network components have been brought together in the network, they have to be lined up and adjusted for optimization of the system. At this stage, quick quality measurements with a Q-factor meter are crucial given the high number of measurements to be performed on multichannel systems (figure 26).

The Q-factor is a “value” providing quality-of-signal (QoS) information. Based on the OSNR, the Q-factor method can estimate very low BER when conventional techniques prove impractical.

Q-factor measurement presents a number of advantages over bit-error rate (BER) measurement including:

- Data format independence
- Short measuring time
- In-service measurement
- High measurement range down to ultra low bit-error rates

figure 26 Parameter optimization and adjustment tests with a Q-factor meter in DWDM systems

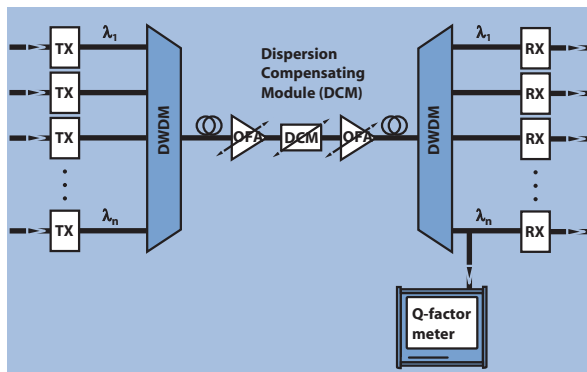

A Q-factor meter is also useful for monitoring purposes as it enables the user to detect changes in QoS at an early stage.

System acceptance tests

Before a network system is handed over to the customer, it must undergo an acceptance test in which all critical optical parameters are measured once more for:

- Center wavelength of each channel
- Spectral stability over time and temperature
- Channel spacing and channel crosstalk
- Peak power of each channel and overall/total power
- OSNR
- Gain and noise figures

The measurements of the digital parameters are performed either end-to-end (before the transponder and behind the receiver) or via a loop through the entire DWDM system. The following parameters can be tested with a signal analyzer:

- Jitter transfer function (JTF)
- Wander analysis
- Pointer analysis
- Path trace
- Alarm tests
- Transmission clock transparency

figure 27 Zero bit-error test (soak test)

- Performance monitoring (B1 byte)
- Round trip delay (needs to be done in loop)
- Bit-error rate with pseudo random bit sequence (PRBS) when carried out over 24 hour, 72 hour or longer periods (these are referred to as soak tests)

Up to eight channels can be daisy-chained (see figure 27) to perform BER tests (soak tests)

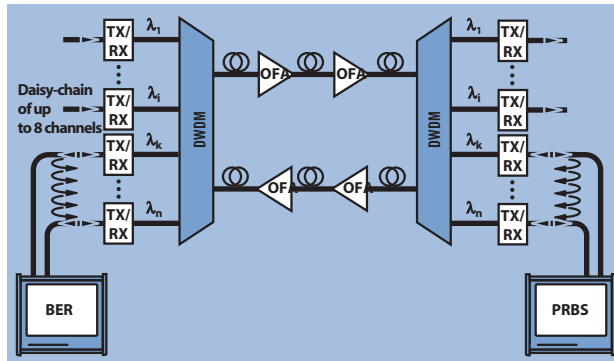
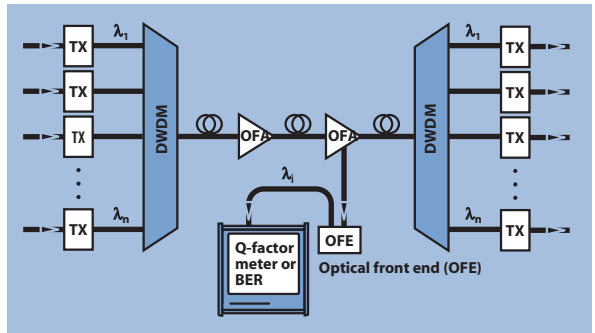

figure 28 In-service troubleshooting with a Q-factor meter or a BER tester

Network management system (NMS) must be reliable given the high capacity (for example, 160 channels of 10 Gbps are equivalent to 645120 E1 signals or 10240 STM-1 signals) transported by DWDM systems. Monitoring performed with NMS is unfortunately only able to find short, significant perturbations. The systems should therefore also be monitored with OTDRs.

For in-service troubleshooting an optical front end (OFE) can be directly connected to the output of an OFA in order to drop a specific channel from the working line (figure 28). This channel can then be fed into a Q-factor meter for quick qualification or into a BER tester.



Summary

DWDM infrastructures provide solid foundations for future telecommunication networks as well as smooth network evolution for service providers through incremental system growth steps. New technologies will soon reach users in local areas, small businesses or even at home causing the quantity and quality of information to increase.

Optical transport networks

DWDM is just the first step toward full optical networking. The next stage will be the integration of NMSs which are essential for automatic protection switching (APS) and the early detection of QoS deterioration. When management systems functionality is combined with DWDM, the basis of ITU-T G.709 optical transport networks (OTN) is formed.

The digital wrapper (DW) as described in ITU-T G.709 provides the network management required in OTNs. There is also the possibility for restoring the signal by correcting bit-errors which arise from the transmission via forward error correction (FEC). FEC makes it possible to cover longer transmission spans whilst reducing the need for regeneration.

All optical networks (AON)

The next step in the evolution of communication network technologies will be the realization of the optical layer and all optical networks (AON).

figure 29 Control plane for optical switching management within an AON

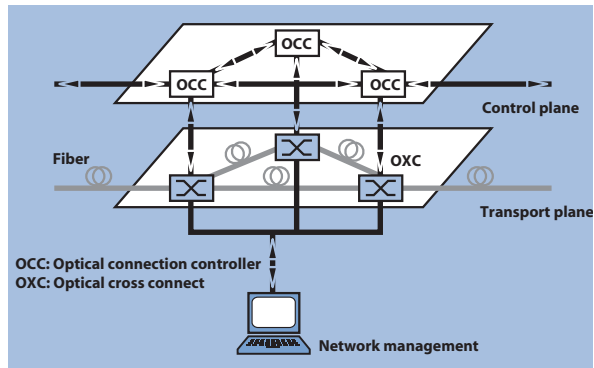

Unlike today's DWDM systems, the optical channels in AON networks are routed and switched via optical add/drop multiplexers (OADM) which use software applications to insert and extract specific wavelengths to and from DWDM signals, and with optical cross connects (OXC) using software applications to connect signals from any input line to any output line. These OXCs are currently still in the development stage.

The AON concept would enable service providers to have optical access to traffic at various nodes in the network. The most important area of development in these networks will be the control plane (located on a different layer to the NMS) which would manage the optical logical switching of the OXCs and OADMs (figure 29).

All optical networks (AON) will be a major part of future communications networks.

Recommendations

In order to plan and implement flexible, future-proof DWDM systems and components, basic standards must be defined to ensure correct interaction of components and modules from different manufacturers. The International Telecommunication Union Telecommunication Sector (ITU-T) is responsible for defining international standards/recommendations. Whilst the standard responsibilities of the ITU-T lie at application level, the International Electrotechnical Commission (IEC) is responsible for those taking effect at product level.

A variety of wavelengths used in telecommunication systems can be selected by individual manufacturers. According to ITU-T G.692, all data channels in DWDM systems should fall into a specified 100 GHz/0.8 nm or 50 GHz/about 0.4 nm channel grid based on a center frequency of 193.1 THz (see table 6). This corresponds to an optical wavelength of 1552.52 nm. Current DWDM deployments tend to use the 50 GHz channel spacing, although spacings of 25 GHz have also been successfully tested.

Table 6 gives an overview of ITU-T recommendations specific to DWDM systems and associated system components.

table 6 ITU-T recommendations for DWDM systems

Recomm- endation number	Title (contents)	Date of last issue	To be revised by
G.650	Definition and test methods for the relevant parameters of singlemode fibers	2000	2003
G.652	Characteristics of a singlemode optical fiber cable (standard fiber)	2000	2002
G.653	Characteristics of a dispersion shifted singlemode optical fiber cable (dispersion shifted fiber (DSF))	2000	2002
G.654	Characteristics of a cut-off shifted singlemode optical fiber cable	2000	2002
G.655	Characteristics of a non-zero dispersion shifted singlemode optical fiber cable (non-zero dispersion shifted fiber (NZDSF))	2000	2003
G.661	Definitions and test methods for the relevant generic parameters of optical amplifier devices and subsystems	1998	2004
G.662	Generic characteristics of optical amplifier devices and subsystems	1998	2004
G.663	Application related aspects of optical amplifier devices and subsystems (describes nonlinear effects)	2000	2004

table 6 (continued)

Recomm- endation number	Title (contents)	Date of last issue	To be revised by
G.664	Optical safety procedures and requirements for optical transport systems	1997	2003
G.692	Optical interfaces for multichannel systems with optical amplifiers (DWDM systems, channel spacing grids and reference test points)	1998	2003
G.709	Interfaces for the optical transport network (OTN) (2.7 Gbps, 10.7 Gbps, 43 Gbps, FEC and digital wrapper)	2001	2003
G.957	Optical interfaces for equipment and systems relating to the synchronous digital hierarchy	1999	2003
G.959.1	Optical transport networks with physical layer interfaces	2001	2003

The following IEC recommendations contain information specific to DWDM systems:

- 61290: Basic specifications for optical test methods
- 61291-1: Optical fiber amplifiers

The electromagnetic spectrum can be divided into different bands for the use in telecommunication transmissions. Though not standardized, figure 30 illustrates the spectral bands and the names by which they are commonly known.

figure 30 Optical bands

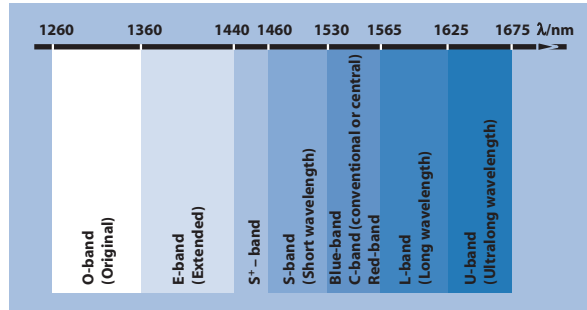

table 7 DWDM frequencies in the 50 GHz and 100 GHz grid and the corresponding wavelengths for a 50 GHz channel spacing according to G.692

Nominal central frequencies (THz) for spacings of 50 GHz	Nominal central frequencies (THz) for spacings of 100 GHz and above	Nominal central wavelengths (nm)
196.10	196.10	1528.77
196.05	–	1529.16
196.00	196.00	1529.55
195.95	–	1529.94
195.90	195.90	1530.33
195.85	–	1530.72
195.80	195.80	1531.12
195.75	–	1531.51
195.70	195.70	1531.90
195.65	–	1532.29
195.60	195.60	1532.68
195.55	–	1533.07
195.50	195.50	1533.47
195.45	–	1533.86
195.40	195.40	1534.25
195.35	–	1534.64
195.30	195.30	1535.04
195.25	–	1535.43
195.20	195.20	1535.82

table 7 (continued)

Nominal central frequencies (THz) for spacings of 50 GHz	Nominal central frequencies (THz) for spacings of 100 GHz and above	Nominal central wavelengths (nm)
195.15	–	1536.22
195.10	195.10	1536.61
195.05	–	1537.00
195.00	195.00	1537.40
194.95	–	1537.79
194.90	194.90	1538.19
194.85	–	1538.58
194.80	194.80	1538.98
194.75	–	1539.37
194.70	194.70	1539.77
194.65	–	1540.16
194.60	194.60	1540.56
194.55	–	1540.95
194.50	194.50	1541.35
194.45	–	1541.75
194.40	194.40	1542.14
194.35	–	1542.54
194.30	194.30	1542.94
194.25	–	1543.33

table 7 (continued)

Nominal central frequencies (THz) for spacings of 50 GHz	Nominal central frequencies (THz) for spacings of 100 GHz and above	Nominal central wavelengths (nm)
194.20	194.20	1543.73
194.15	–	1544.13
194.10	194.10	1544.53
194.05	–	1544.92
194.00	194.00	1545.32
193.95	–	1545.72
193.90	193.90	1546.12
193.85	–	1546.52
193.80	193.80	1546.92
193.75	–	1547.32
193.70	193.70	1547.72
193.65	–	1548.11
193.60	193.60	1548.51
193.55	–	1548.91
193.50	193.50	1549.32
193.45	–	1549.72
193.40	193.40	1550.12
193.35	–	1550.52
193.30	193.30	1550.92

table 7 (continued)

Nominal central frequencies (THz) for spacings of 50 GHz	Nominal central frequencies (THz) for spacings of 100 GHz and above	Nominal central wavelengths (nm)
193.25	–	1551.32
193.20	193.20	1551.72
193.15	–	1552.12
193.10	193.10	1552.52
193.05	–	1552.93
193.00	193.00	1553.33
192.95	–	1553.73
192.90	192.90	1554.13
192.85	–	1554.54
192.80	192.80	1554.94
192.75	–	1555.34
192.70	192.80	1555.75
192.65	–	1556.15
192.60	192.60	1556.55
192.55	–	1556.96
192.50	192.50	1557.36
192.45	–	1557.77
192.40	192.40	1558.17
192.35	–	1558.58

table 7 (continued)

Nominal central frequencies (THz) for spacings of 50 GHz	Nominal central frequencies (THz) for spacings of 100 GHz and above	Nominal central wavelengths (nm)
192.30	192.30	1558.98
192.25	–	1559.39
192.20	192.20	1559.79
192.15	–	1560.20
192.10	192.10	1560.61

Abbreviation	Description
AON	All optical network
APS	Automatic protection switching
ASE	Amplified spontaneous emission
ATM	Asynchronous transfer mode
BER	Bit-error ratio
CD	Chromatic dispersion
dB	Decibel
DCF	Dispersion compensating fiber
DCM	Dispersion compensating module
DEMUX	Demultiplexer
DSF	Dispersion shifted fiber
DW	Digital wrapper
DWDM	Dense wavelength division multiplexing
E/O	Electrical-to-optical converter
EDFA	Erbium doped fiber amplifier
FEC	Forward error correction
FWM	Four wave mixing
Gbps	Gigabit per second
GigE	Gigabit ethernet
IEC	International electrotechnical commission
IL	Insertion loss
IP	Internet protocol

Abbreviation	Description
ITU	International Telecommunication Union
ITU-T	ITU Telecommunication Sector
JTF	Jitter transfer function
MPI	Main point of interest
MUX	Multiplexer
mW	Milliwatt
nm	Nanometer
NMS	Network management system
NZDSF	Non-zero dispersion shifted fiber
O/E	Optical-to-electrical converter
OADM	Optical add/drop multiplexer
OCC	Optical connection controller
OFA	Optical fiber amplifier
OFE	Optical front end
OQM	Optical Q-factor meter
ORL	Optical return loss
OSA	Optical spectrum analyzer
OSC	Optical supervisory channel
OSNR	Optical signal-to-noise ratio
OTDR	Optical time domain reflectometer
OTN	Optical transport networks
OXC	Optical cross connect

Abbreviation	Description
PDL	Polarization dependent loss
PMD	Polarization mode dispersion
PoS	Packet over SONET/SDH
PRBS	Pseudo random binary sequence
QoS	Quality of signal
RFA	Raman fiber amplifier
RX	Receiver
SBS	Stimulated Brillouin scattering
SDH	Synchronous digital hierarchy
SOA	Semiconductor optical amplifier
SONET	Synchronous optical network
SPM	Self phase modulation
SRS	Stimulated Raman scattering
Tbps	Terrabit per second
TDM	Time division multiplexing
TX	Transponder
WDM	Wavelength division multiplexing
XPM	Cross phase modulation

Notes

All statements, technical information and recommendations related to the products herein are based upon information believed to be reliable or accurate. However, the accuracy or completeness thereof is not guaranteed, and no responsibility is assumed for any inaccuracies. The user assumes all risks and liability whatsoever in connection with the use of a product or its application. JDSU reserves the right to change at any time without notice the design, specifications, function, fit or form of its products described herein, including withdrawal at any time of a product offered for sale herein. JDSU makes no representations that the products herein are free from any intellectual property claims of others. Please contact JDSU for more information. JDSU and the JDSU logo are trademarks of JDS Uniphase Corporation. Other trademarks are the property of their respective holders. ©2005 JDS Uniphase Corporation. All rights reserved.

Test & Measurement Regional Sales

30137129 500 1005 DWDM.PG.OPT.TM.AE

North America

Toll Free: 1 866 228 3762

Tel: +1 301 353 1560 x 2850

Fax: +1 301 353 9216

Latin America

Tel: +55 11 5503 3800

Fax: +55 11 5505 1598

Asia Pacific

Tel: +852 2892 0990

Fax: +852 2892 0770

EMEA

Tel.: +49 7121 86 2222

Fax: +49 7121 86 1222

www.jdsu.com